

200mA Ultra-Small Regulator IC

Monolithic IC MM3436

Outline

This IC is a high speed response 200mA regulator IC with low quiescent current and high ripple rejection. No load input current is 20µA typ. And ripple rejection is 75dB typ. Dropout voltage is low at 80mV typ., and the output current is 200mA. Therefore the IC applies to most mobile equipment. Significant space efficiency realized through its ultra-small package size of 1.0 mm × 1.0 mm.

Features

1. Output current	200mA
2. No load input current	20µA typ.
3. Input current (OFF)	0.1µA max.
4. Output voltage range	0.8-5.0V
5. Output voltage accuracy	±1% (±20mV, Vo<2V)
6. Dropout voltage	80mV typ. (Io=100mA)
7. Line regulation	±0.2%/V max.
8. Load regulation	40mV max.(Io=0.1~100mA)
9. Ripple rejection	75dB typ. (f=1kHz)
10. Output Capacitor	1µF

Package

PLP-4A

Applications

1. Cellular phones
2. Digital still cameras
3. Mobile equipments

Model Name

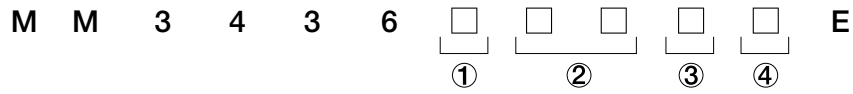

①		②	
Function Type		Voltage Output RANK	
A	CE=H-Active, with Discharge Function	08	①="A, B, C" V _o (typ.)=0.8V
Z			①="Z, Y, W" V _o (typ.)=0.85V
B	CE=L-Active, with Discharge Function	2	①="A, B, C" V _o (typ.) is 0.1V steps
Y			①="Z, Y, W" V _o (typ.) =0.05V steps
C	CE=H-Active, without Discharge Function	50	①="A, B, C" V _o (typ.) =5.0V
W			

③		④	
Package		Packing Specifications	
R	PLP-4A (1010 size)	R	R HOUSING (Standard)
		L	L HOUSING

• Any products mentioned in this catalog are subject to any modification in their appearance and others for improvements without prior notification.
 • The details listed here are not a guarantee of the individual products at the time of ordering. When using the products, you will be asked to check their specifications.

Block Diagram

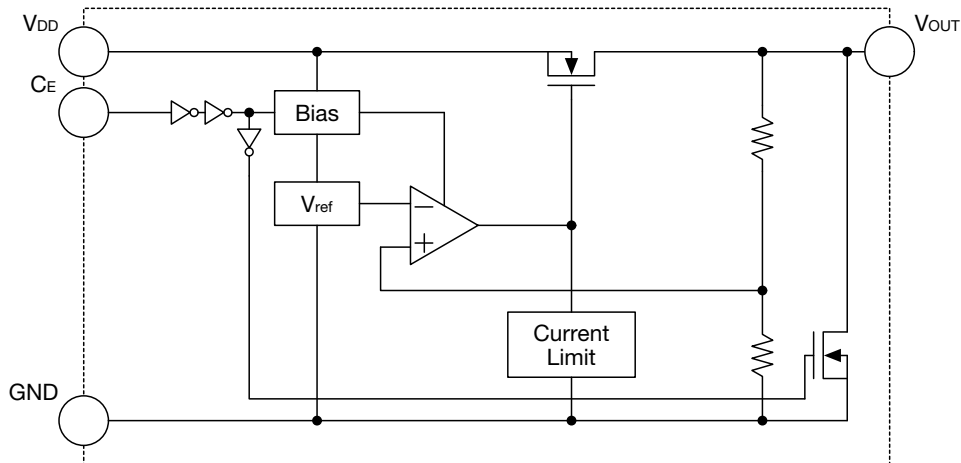

Pin Assignment

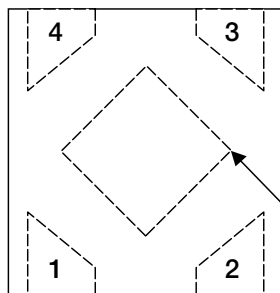

Heat Spreader Bottom
Note1

1	V_{OUT}
2	GND
3	CE
4	V_{DD}

PLP-4A
(TOP VIEW)

Pin Description

Pin No.	Pin name	Functions	Internal equivalent circuit					
1	V_{OUT}	Output pin	Please refer to BLOCK DIAGRAM.					
2	GND	GND pin						
3	CE	ON/OFF-Control pin						
		<table border="1"> <tr> <td>CE</td> <td>Output</td> </tr> <tr> <td>L</td> <td>OFF</td> </tr> <tr> <td>H</td> <td>ON</td> </tr> </table>		CE	Output	L	OFF	H
		CE	Output					
L	OFF							
H	ON							
Connect CE pin with V_{DD} pin, when it is not used.								
4	V_{DD}	Voltage-Supply pin						

Note1 : Heat Spreader Bottom with GND.

Absolute Maximum Ratings (Except where noted otherwise Ta=25°C)

Item	Symbol	Ratings	Units
Storage Temperature	T _{stg}	-55~+150	°C
Supply Voltage	V _{DD}	-0.3~+7.0	V
CE Input Voltage	V _{CE}	-0.3~V _{DD} +0.3	V
Output Voltage	V _{OUT}	-0.3~V _{DD} +0.3	V
Output Current	I _{omax}	400	mA
Power Dissipation	P _d	400 (Note2)	mW

Note2 : With the double sided PC Board of glass epoxy. (40 × 40 × 1.6mm copper plane 90%)

Recommended Operating Conditions (Except where noted otherwise Ta=25°C)

Item	Symbol	Ratings	Units
Operating Ambient Temperature	T _{jop}	-40~+85	°C
Operating Voltage	V _{op}	1.6~6.5	V
Output Current	I _o	0~200	mA

Electrical Characteristics 1 (Except where noted otherwise V_{DD}=V_{out}(typ.)+1V, V_{CE}=V_{DD}, Ta=25°C)

Item	Symbol	Measurement conditions	Min.	Typ.	Max.	Units
Input Current(OFF)	I _{DDoff}	V _{CE} =0V		0.01	0.1	μA
No-Load Input Current	I _{DD}	I _{OUT} =0mA		20	50	μA
Output Voltage	V _{OUT}	I _{OUT} =10mA (V _{OUT} ≥2.0V)	×0.99		×1.01	V
		I _{OUT} =10mA (V _{OUT} ≤1.95V)	-0.02		0.02	V
Line Regulation	V _{LINE}	V _O (typ.)+0.5≤V _{DD} ≤6.5V V _{OUT} ≥1.1V, I _{OUT} =10mA		0.01	0.2	% / V
		1.6V≤V _{DD} ≤6.5V V _{OUT} ≤1.05V, I _{OUT} =10mA				
Load Regulation	V _{LOAD}	0.1mA≤I _{OUT} ≤100mA		10	40	mV
Dropout Voltage	V _{io}	Please refer to another page				V
Ripple Rejection (Note3)	RR	f=1kHz, V _{ripple} =0.5V, I _{OUT} =30mA V _{OUT} ≥0.85V		75		dB
		f=1kHz, V _{ripple} =0.5V, I _{OUT} =30mA V _{OUT} =0.8V				
V _{OUT} Temperature Coefficient (Note3)	ΔV _{OUT} /ΔT	I _{OUT} =30mA, -40≤T _{op} ≤+85°C		±50		ppm/°C
Output Current Limit	I _{lim}		200	250		mA
Output Short-Circuit Current	I _{short}	V _{OUT} =0V		30		mA
CE High Threshold Voltage	V _{CEH}		1.2		6.0	V
CE Low Threshold Voltage	V _{CEL}				0.3	V
CE High Threshold Current	I _{CEH}		-0.1		0.1	μA
CE Low Threshold Current	I _{CEL}		-0.1		0.1	μA
CL Discharge Resistance	R _{disc}			780		Ω

Note3 : The parameter is guaranteed by design.

Electrical Characteristics 2 (Except where noted otherwise $V_{DD}=V_{OUT}(typ.)+1V$, $V_{CE}=V_{DD}$, $T_a=25^{\circ}C$)

Model No.	Item								
	Output Voltage				Dropout Voltage				
	VOUT (V)				Vio (mV)				
	Measurement Conditions	Min.	Typ.	Max.	Measurement Conditions	Min.	Typ.	Max.	
MM3436A08	Iout=10mA	0.780	0.800	0.820	IOUT=100mA Vout≤1.5V (Note4)		500	850	
MM3436Z08		0.830	0.850	0.870			410	750	
MM3436A09		0.880	0.900	0.920			330	650	
MM3436Z09		0.930	0.950	0.970			230	380	
MM3436A10		0.980	1.000	1.020			200	360	
MM3436Z10		1.030	1.050	1.070			180	290	
MM3436A11		1.080	1.100	1.120			160	250	
MM3436Z11		1.130	1.150	1.170			125	210	
MM3436A12		1.180	1.200	1.220			IOUT=100mA Vout≥1.5V VDD=VOUT (typ.) -0.2V	115	195
MM3436Z12		1.230	1.250	1.270				95	170
MM3436A13		1.280	1.300	1.320					
MM3436Z13		1.330	1.350	1.370					
MM3436A14		1.380	1.400	1.420					
MM3436Z14		1.430	1.450	1.470					
MM3436A15		1.480	1.500	1.520					
MM3436Z15		1.530	1.550	1.570					
MM3436A16		1.580	1.600	1.620					
MM3436Z16		1.630	1.650	1.670					
MM3436A17		1.680	1.700	1.720					
MM3436Z17		1.730	1.750	1.770					
MM3436A18		1.780	1.800	1.820					
MM3436Z18		1.830	1.850	1.870					
MM3436A19		1.880	1.900	1.920					
MM3436Z19		1.930	1.950	1.970					
MM3436A20		1.980	2.000	2.020					
MM3436Z20		2.030	2.050	2.071					
MM3436A21		2.079	2.100	2.121					
MM3436Z21		2.129	2.150	2.172					
MM3436A22		2.178	2.200	2.222					
MM3436Z22		2.228	2.250	2.273					
MM3436A23		2.277	2.300	2.323					
MM3436Z23		2.327	2.350	2.374					
MM3436A24	2.376	2.400	2.424						
MM3436Z24	2.426	2.450	2.475						
MM3436A25	2.475	2.500	2.525						
MM3436Z25	2.525	2.550	2.576						
MM3436A26	2.574	2.600	2.626						
MM3436Z26	2.624	2.650	2.677						
MM3436A27	2.673	2.700	2.727						
MM3436Z27	2.723	2.750	2.778						
MM3436A28	2.772	2.800	2.828						
MM3436Z28	2.822	2.850	2.879						
MM3436A29	2.871	2.900	2.929						
MM3436Z29	2.921	2.950	2.980						

Note4 : Dropout voltage MAX value in the input and it is confirmed that there is no output abnormal voltage impression the load 100mA in the model less than Vout=1.5V.

• Any products mentioned in this catalog are subject to any modification in their appearance and others for improvements without prior notification.
 • The details listed here are not a guarantee of the individual products at the time of ordering. When using the products, you will be asked to check their specifications.

Model No.	Item							
	Output Voltage				Dropout Voltage			
	V _{OUT} (V)				V _{io} (mV)			
	Measurement Conditions	Min.	Typ.	Max.	Measurement Conditions	Min.	Typ.	Max.
MM3436A30	I _{out} =10mA	2.970	3.000	3.030	I _{OUT} =100mA V _{out} ≥1.5V V _{DD} =V _{OUT} (typ.) -0.2V		80	140
MM3436Z30		3.020	3.050	3.081				
MM3436A31		3.069	3.100	3.131				
MM3436Z31		3.119	3.150	3.182				
MM3436A32		3.168	3.200	3.232				
MM3436Z32		3.218	3.250	3.283				
MM3436A33		3.267	3.300	3.333				
MM3436Z33		3.317	3.350	3.384				
MM3436A34		3.366	3.400	3.434				
MM3436Z34		3.416	3.450	3.485				
MM3436A35		3.465	3.500	3.535				
MM3436Z35		3.515	3.550	3.586				
MM3436A36		3.564	3.600	3.636				
MM3436Z36		3.614	3.650	3.687				
MM3436A37		3.663	3.700	3.737				
MM3436Z37		3.713	3.750	3.788				
MM3436A38		3.762	3.800	3.838				
MM3436Z38		3.812	3.850	3.889				
MM3436A39		3.861	3.900	3.939				
MM3436Z39		3.911	3.950	3.990				
MM3436A40		3.960	4.000	4.040				
MM3436Z40		4.010	4.050	4.091				
MM3436A41		4.059	4.100	4.141				
MM3436Z41		4.109	4.150	4.192				
MM3436A42		4.158	4.200	4.242				
MM3436Z42		4.208	4.250	4.293				
MM3436A43		4.257	4.300	4.343				
MM3436Z43		4.307	4.350	4.394				
MM3436A44		4.356	4.400	4.444				
MM3436Z44		4.405	4.450	4.495				
MM3436A45		4.455	4.500	4.545				
MM3436Z45		4.504	4.550	4.595				
MM3436A46	4.554	4.600	4.646					
MM3436Z46	4.603	4.650	4.696					
MM3436A47	4.653	4.700	4.747					
MM3436Z47	4.702	4.750	4.797					
MM3436A48	4.752	4.800	4.848					
MM3436Z48	4.801	4.850	4.898					
MM3436A49	4.851	4.900	4.949					
MM3436Z49	4.900	4.950	4.999					
MM3436A50	4.950	5.000	5.050					

• Any products mentioned in this catalog are subject to any modification in their appearance and others for improvements without prior notification.
 • The details listed here are not a guarantee of the individual products at the time of ordering. When using the products, you will be asked to check their specifications.

Measuring Circuit

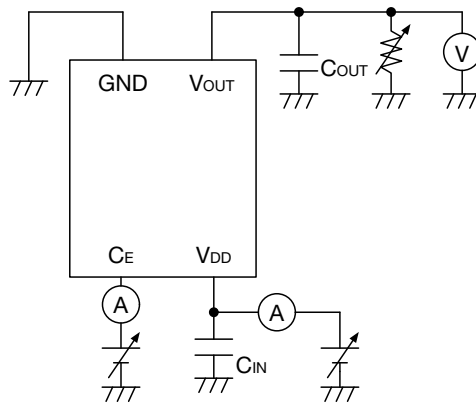

Application Circuit

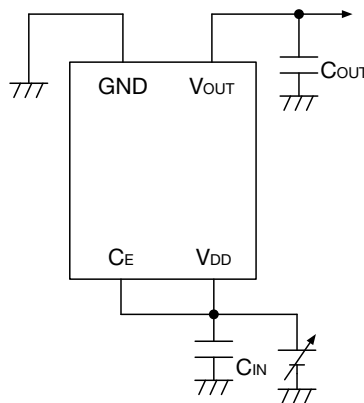

★ Temperature Characteristics : B Type

(reference example of external parts)

- Output capacitor Ceramic capacitor 1.0 μ F
- Input Capacitor Ceramic capacitor 1.0 μ F

· Note

1. The output capacitor is required between output and GND to prevent oscillation.
2. The ESR of capacitor must be defined in ESR stability area.
It is possible to use a ceramic capacitor without ESR resistance for output.
The ceramic capacitor must be used more than 1.0 μ F and B temperature characteristics.
3. The wire of Vcc and GND is required to print full ground plane for noise and stability.
4. The input capacitor must be connected a distance of less than 1cm from input pin.
5. In case the output voltage is above the input voltage, the overcurrent flow by internal parastic diode from output to input.

Characteristics (Vo=0.8V) (Except where noted otherwise $V_{DD}=V_{OUT}(typ.)+1V$, $V_{CE}=V_{DD}$, $T_a=25^{\circ}C$)

Output - Input voltage

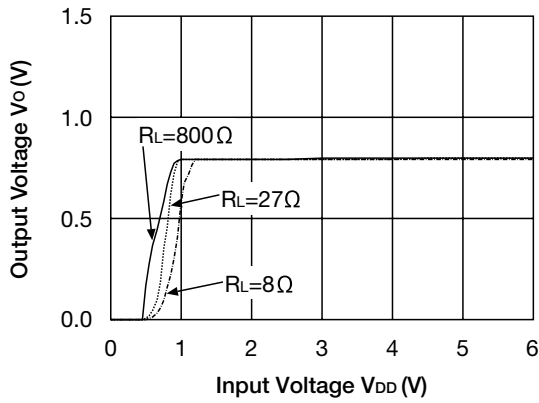

Input current - Input voltage

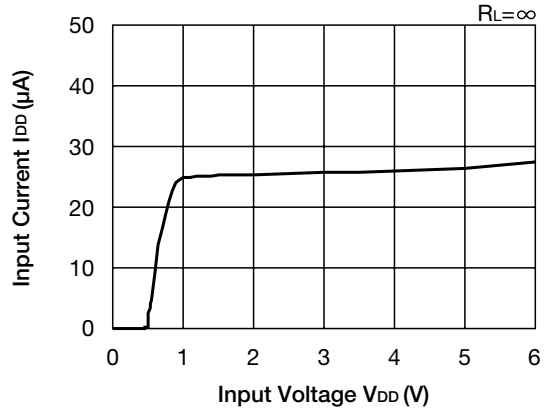

Load regulation

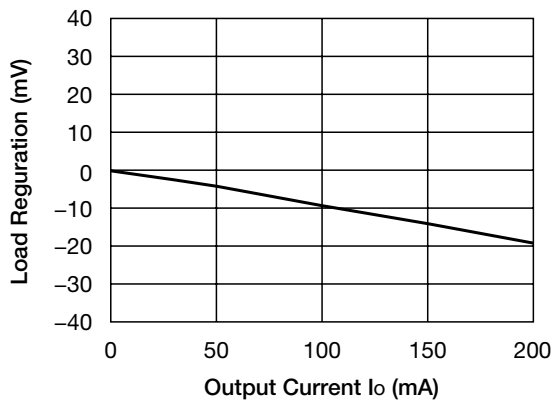

Line regulation

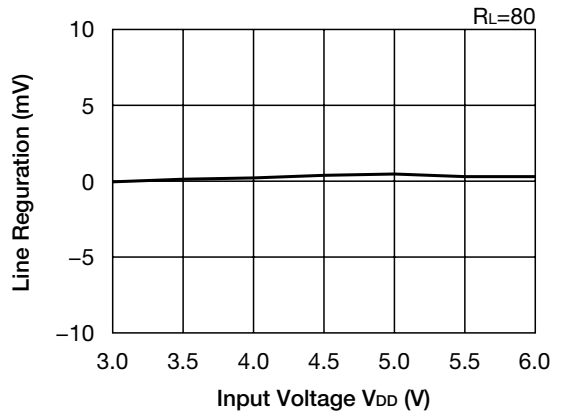

V_{OUT} temperature coefficient

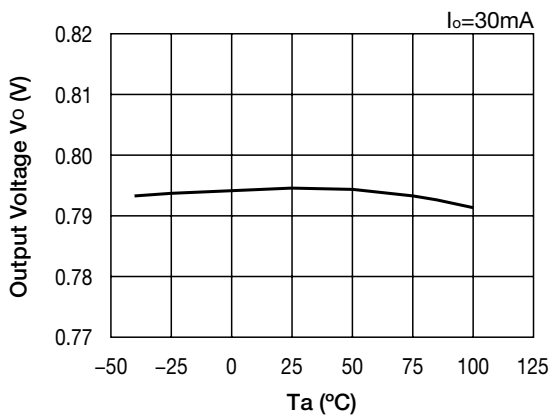

Ripple Rejection

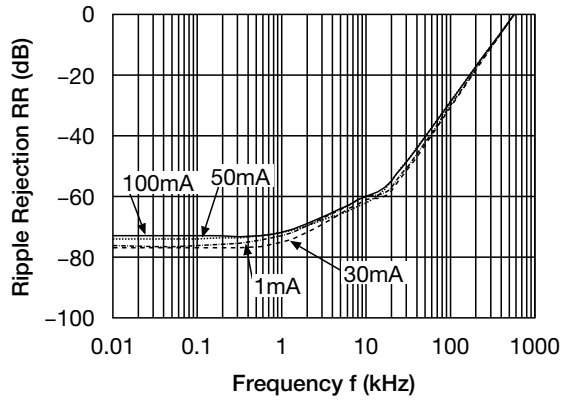

ESR Stable area

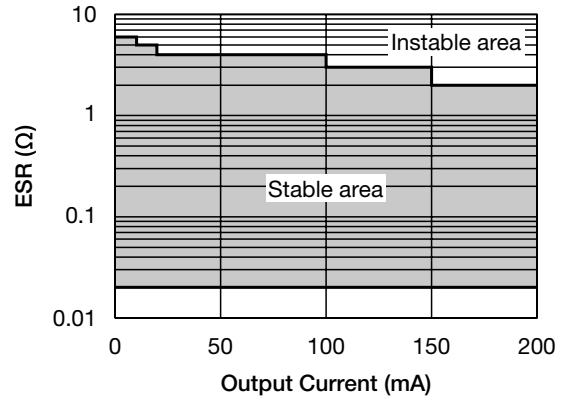

Current limit

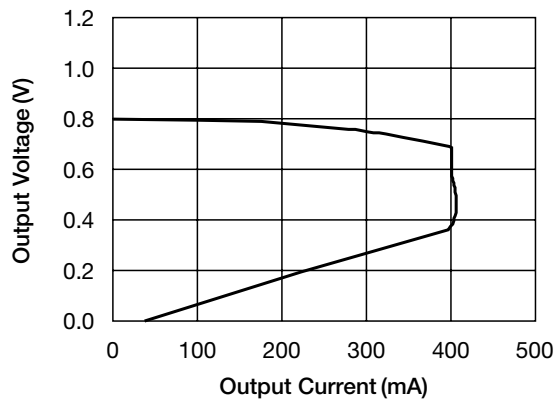

■ Load transient response ($V_{DD}=V_o+1V$, $V_{CE}=V_{DD}$, $C_{in}=C_o=1\mu F$)

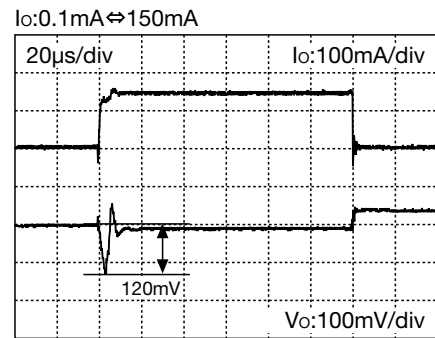
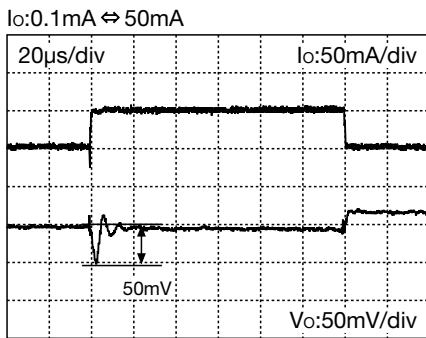
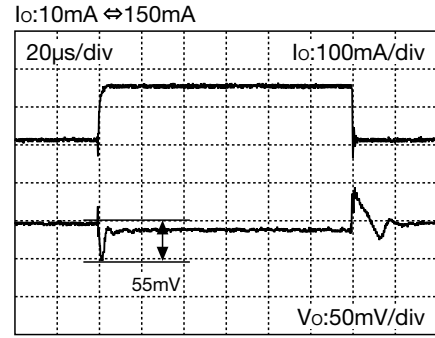
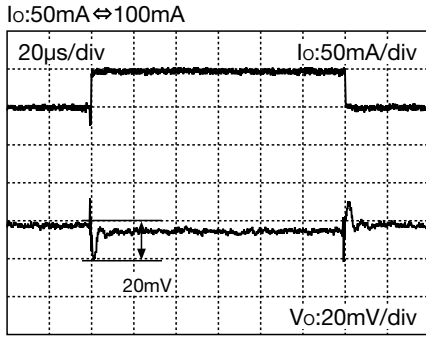

■ Input rise characteristics
($V_{DD}=0V \rightarrow 1.8V$, $V_{CE}=V_{DD}$, $I_o=30mA$)

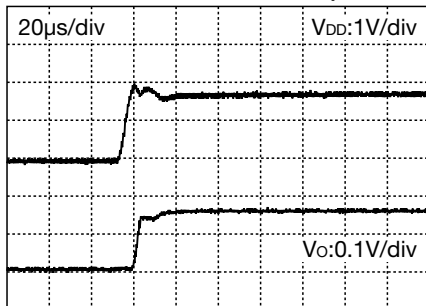

■ CE rise characteristics
($V_{DD}=1.8V$, $V_{CE}=0V \rightarrow V_{DD}$, $I_o=30mA$)

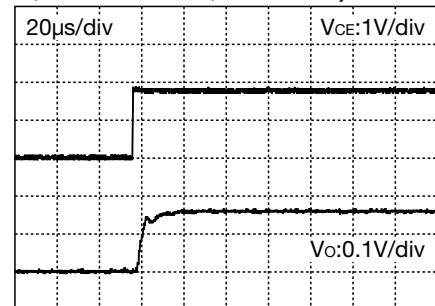

Characteristics (Vo=3.0V) (Except where noted otherwise $V_{DD}=V_{OUT}(typ.)+1V$, $V_{CE}=V_{DD}$, $T_a=25^{\circ}C$)

Output - Input voltage

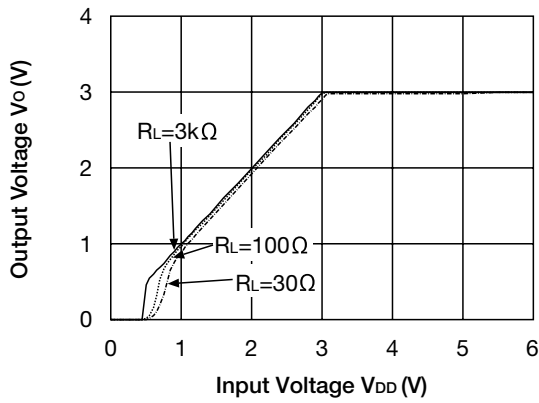

Input current - Input voltage

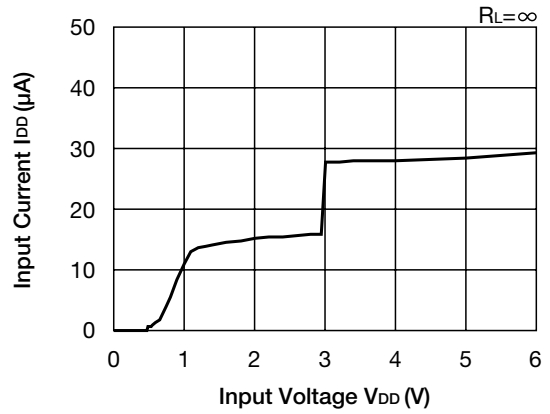

Load regulation

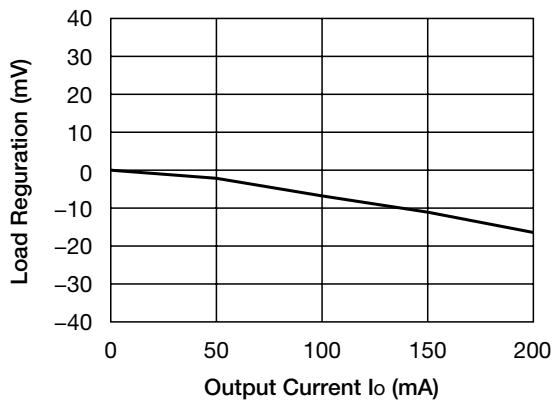

Line regulation

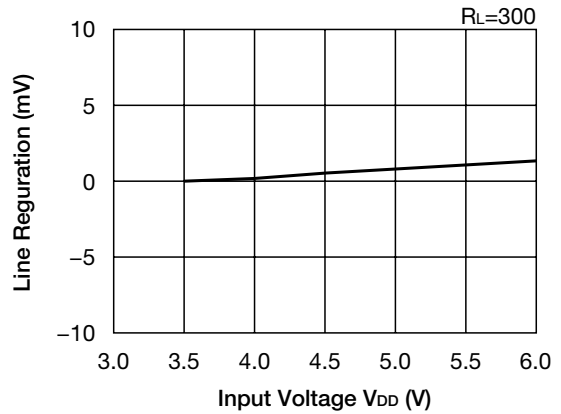

Dropout voltage

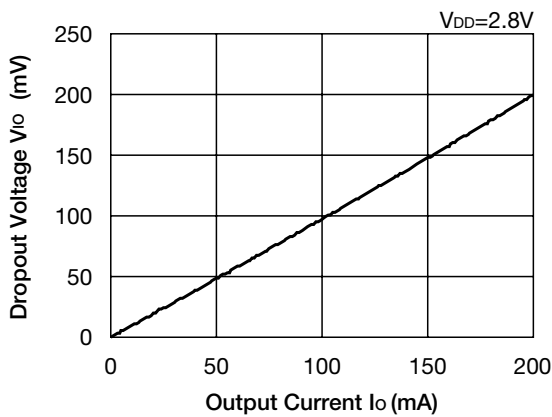

VOUT temperature coefficient

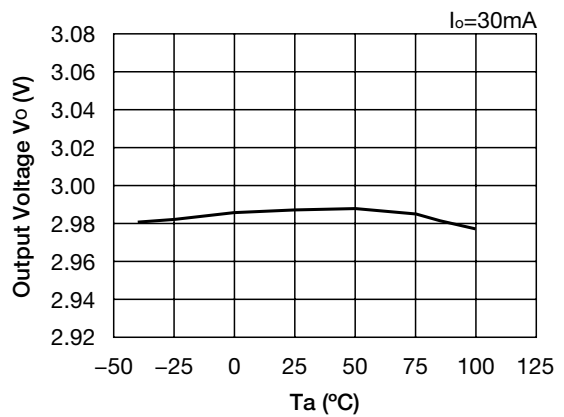

• Any products mentioned in this catalog are subject to any modification in their appearance and others for improvements without prior notification.
 • The details listed here are not a guarantee of the individual products at the time of ordering. When using the products, you will be asked to check their specifications.

Ripple Rejection

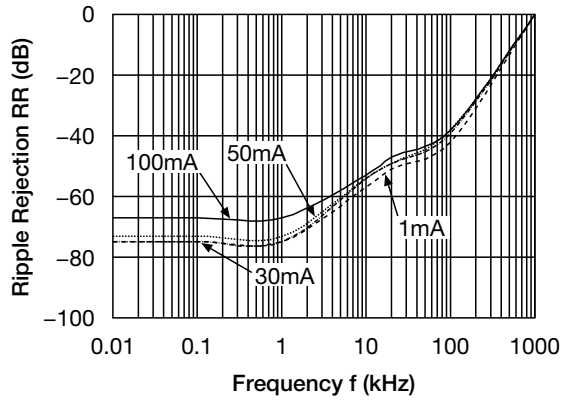

ESR Stable area

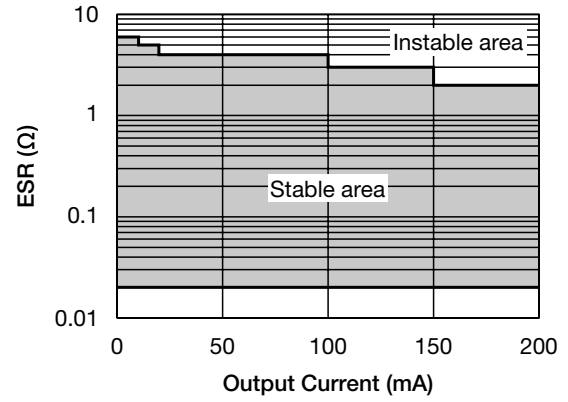

Current limit

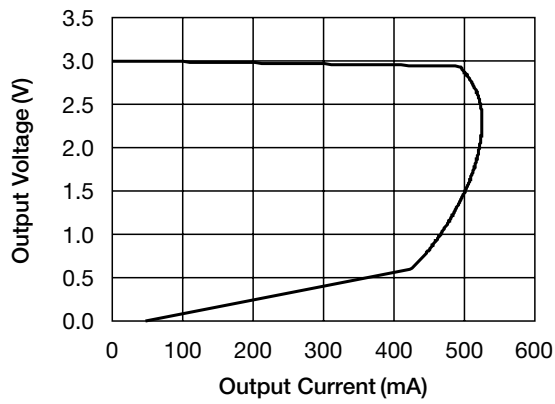

■ Load transient response ($V_{DD}=V_o+1V$, $V_{CE}=V_{DD}$, $C_{in}=C_o=1\mu F$)

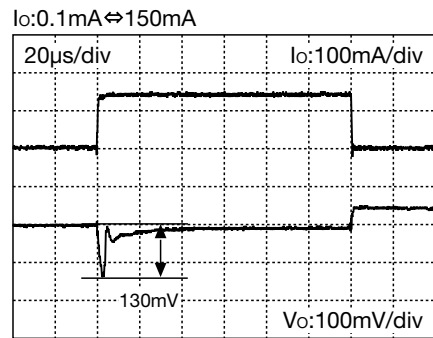
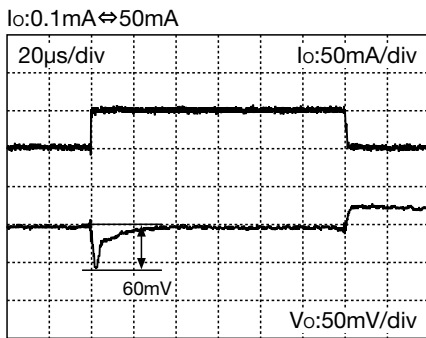
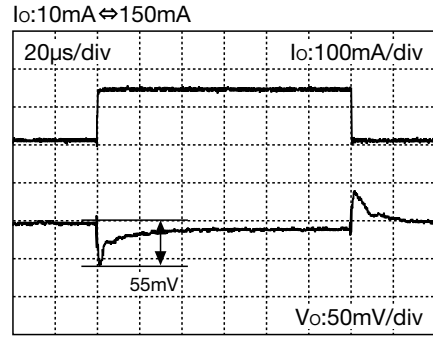
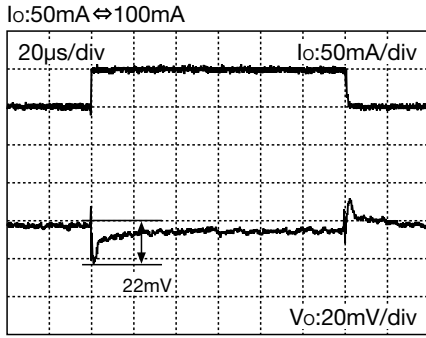

■ Input rise characteristics
($V_{DD}=0V \rightarrow 4.0V$, $V_{CE}=V_{DD}$, $I_o=30mA$)

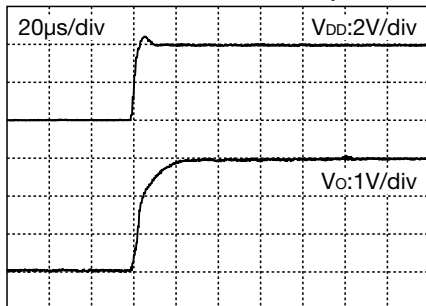

■ CE rise characteristics
($V_{DD}=4.0V$, $V_{CE}=0V \rightarrow V_{DD}$, $I_o=30mA$)

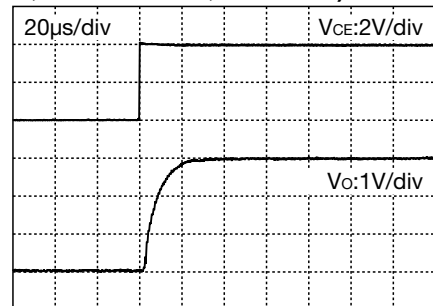

Characteristics (Vo=5.0V) (Except where noted otherwise $V_{DD}=V_{OUT}(typ.)+1V$, $V_{CE}=V_{DD}$, $T_a=25^{\circ}C$)

Output - Input voltage

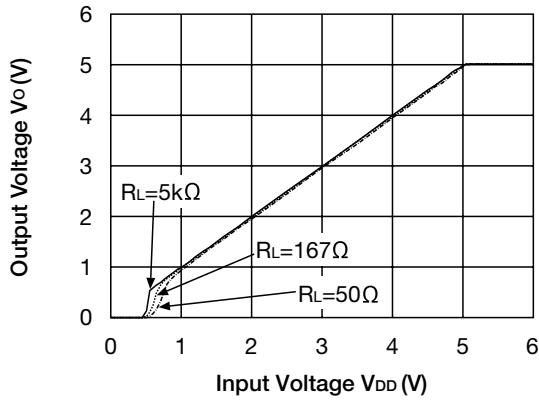

Input current - Input voltage

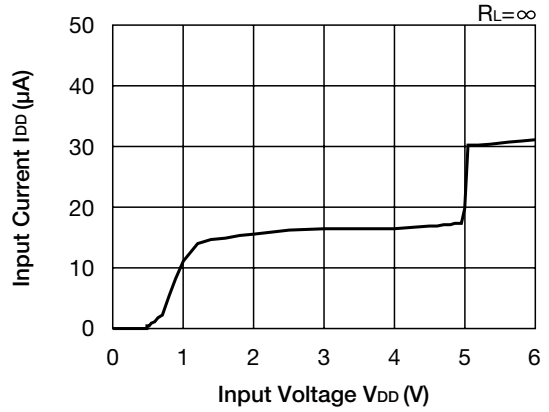

Load regulation

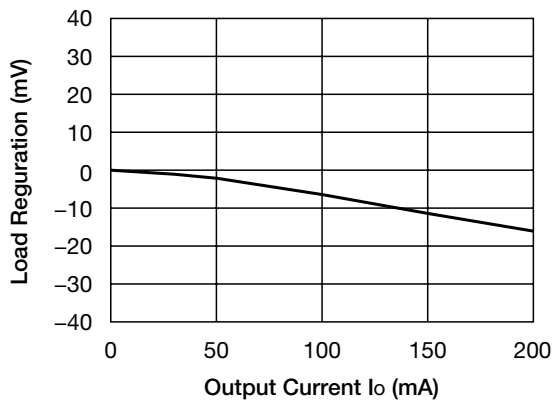

Line regulation

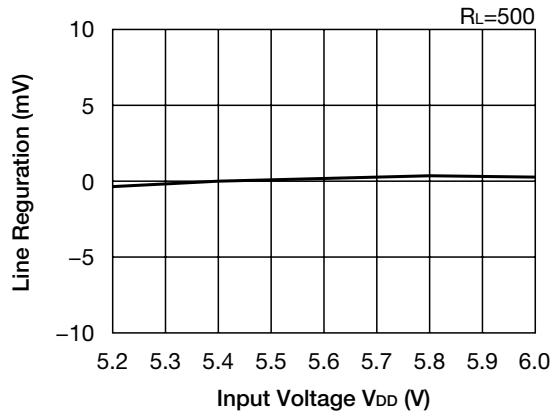

Dropout voltage

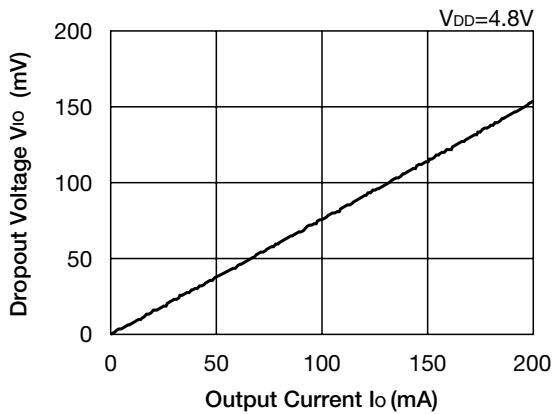

VOUT temperature coefficient

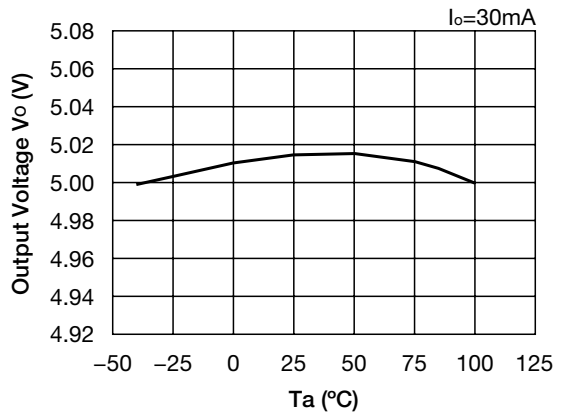

Ripple Rejection

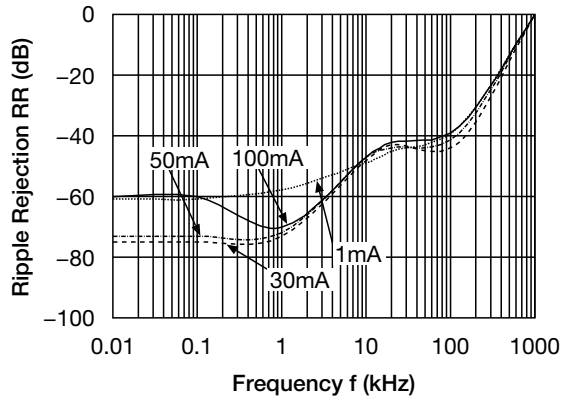

ESR Stable area

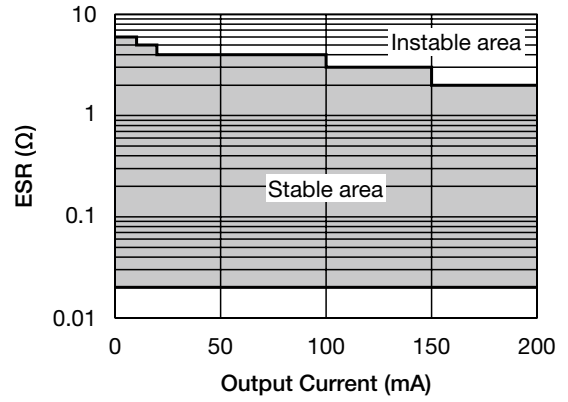

Current limit

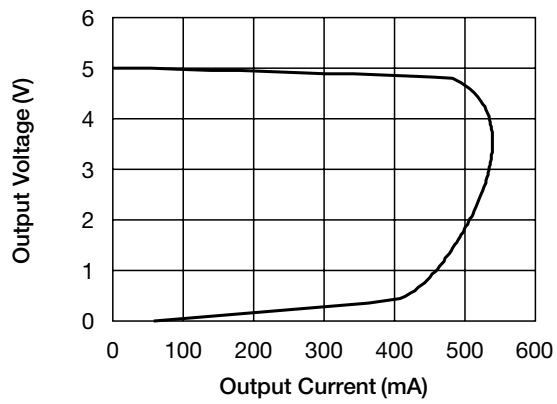

■ Load transient response ($V_{DD}=V_o+1V$, $V_{CE}=V_{DD}$, $C_{in}=C_o=1\mu F$)

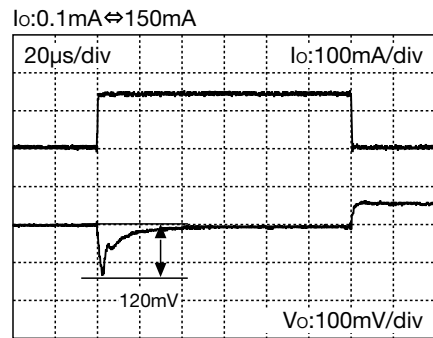
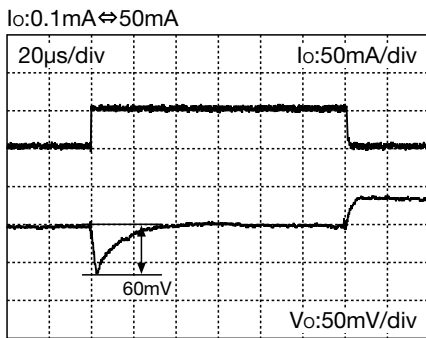
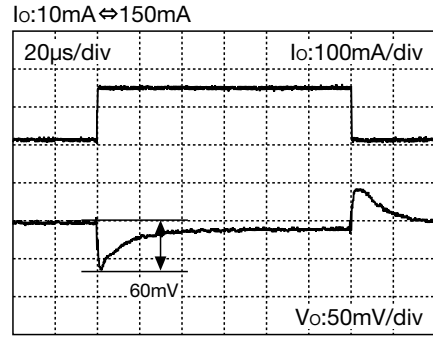
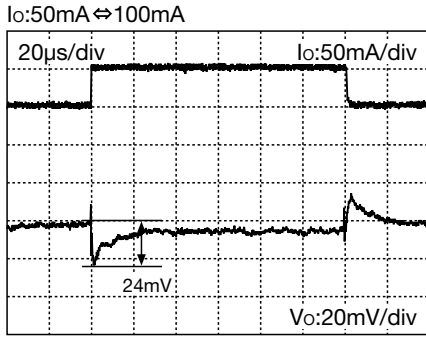

■ Input rise characteristics
($V_{DD}=0V \rightarrow 6.0V$, $V_{CE}=V_{DD}$, $I_o=30mA$)

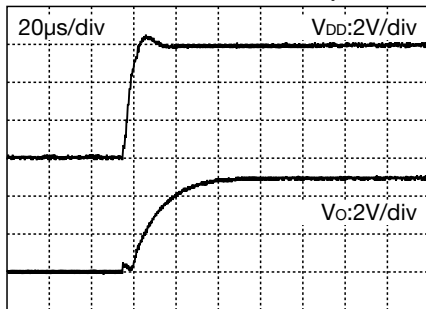

■ CE rise characteristics
($V_{DD}=6.0V$, $V_{CE}=0V \rightarrow V_{DD}$, $I_o=30mA$)

