

150mA LDO with auto power save Monolithic IC MM336x

Outline

This IC is a 150 mA LDO featuring automatic power-saving.

This device automatically switches between a high-speed operation mode and low-power mode depending on the load current. In the low power mode, current consumption is lowered to 4.5 μ A.

This device is suitable for cell-phones which require low power consumption in standby mode and other such applications.

Features

1. Input voltage range	2~6V
2. Output voltage range	1.5~5V
3. Output voltage accuracy	$V_{OUT} \pm 1\%$
4. Maximum output current	150mA
5. Supply current	4.5 μ A typ. (No-load) 0.01 μ A typ. (OFF)
6. Output capacitor	1 μ F
7. Dropout capacitor	0.14V typ. ($V_o=3V, I_o=100mA$)
8. Short current	50mA typ.
9. Line regulation	0.01%/V
10. Load regulation	15mV typ. ($I_o=1\sim 80mA$)
11. Ripple rejection	70dB typ. ($f=1kHz$)

Package

SOT-25A
SSON-4B

Applications

1. Mobile phones
2. Digital still cameras

Block Diagram

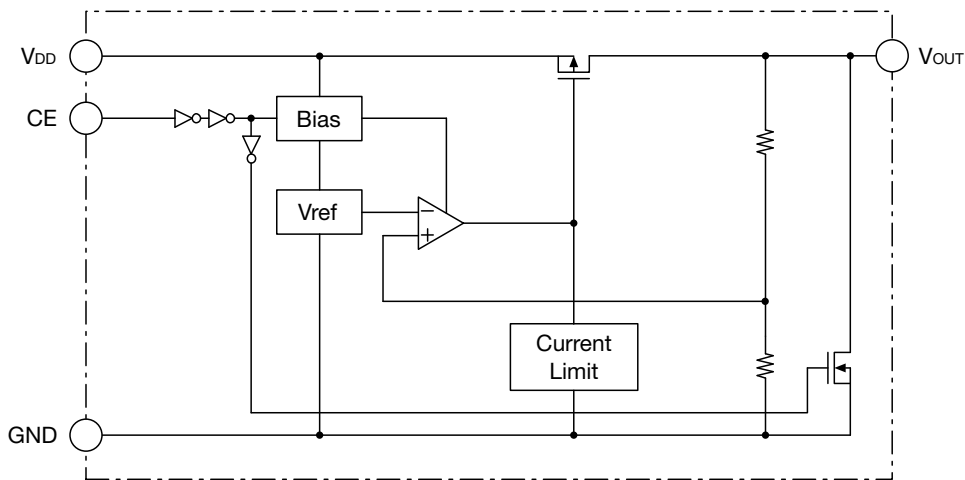

Pin Assignment

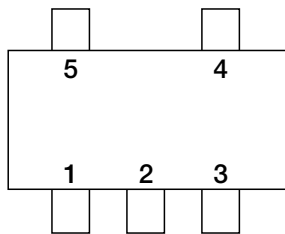

SOT-25A
(TOP VIEW)

1	V _{DD}
2	GND
3	CE
4	NC
5	V _{OUT}

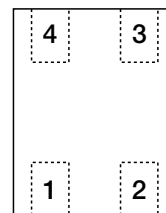

SSON-4B
(TOP VIEW)

1	CE
2	V _{DD}
3	V _{OUT}
4	GND

Pin Description

SOT-25A

Pin No.	Pin name	Functions						
1	V _{DD}	Voltage-supply pin						
2	GND	GND pin						
3	CE	ON/OFF-Control pin						
		<table border="1"> <tr> <th>CE</th> <th>OUTPUT</th> </tr> <tr> <td>Low</td> <td>OFF</td> </tr> <tr> <td>High</td> <td>ON</td> </tr> </table>	CE	OUTPUT	Low	OFF	High	ON
		CE	OUTPUT					
Low	OFF							
High	ON							
Connect CE pin with V _{DD} pin, when it is not used.								
4	NC	No connection						
5	V _{OUT}	Output pin						

SSON-4B

Pin No.	Pin name	Functions						
1	CE	ON/OFF-Control pin						
		<table border="1"> <tr> <th>CE</th> <th>OUTPUT</th> </tr> <tr> <td>Low</td> <td>OFF</td> </tr> <tr> <td>High</td> <td>ON</td> </tr> </table>	CE	OUTPUT	Low	OFF	High	ON
		CE	OUTPUT					
Low	OFF							
High	ON							
Connect CE pin with V _{DD} pin, when it is not used.								
2	V _{DD}	Voltage-supply pin						
3	V _{OUT}	Output pin						
4	GND	GND pin						

• Any products mentioned in this catalog are subject to any modification in their appearance and others for improvements without prior notification.
 • The details listed here are not a guarantee of the individual products at the time of ordering. When using the products, you will be asked to check their specifications.

Absolute Maximum Ratings (Except where noted otherwise Ta=25°C)

Item	Symbol	Ratings	Units
Storage Temperature	T _{STG}	-55~+150	°C
Supply Voltage	V _{DD}	-0.3~7.0	V
CE input Voltage	V _{CE}	-0.3~V _{DD} +0.3	V
Output Voltage	V _{OUT}	-0.3~V _{DD} +0.3	V
Output Current	I _{omax}	200	mA
Power Dissipation	Pd	350(Note1)	SOT-25A
		330(Note2)	SSON-4B

Note1 : With PC Board of glass epoxy (60 × 40 × 1.6^tmm)

Note2 : With PC Board of glass epoxy (110 × 40 × 0.8^tmm)

Recommended Operating Conditions (Except where noted otherwise Ta=25°C)

Item	Symbol	Ratings	Units
Operating Ambient Temperature	T _{JOP}	-40~85	°C
Operating Voltage	V _{OP}	2.0~6.0	V
Output Current	I _O	0~150	mA

Electrical Characteristics 1 (Except where noted otherwise V_{DD}=V_{OUT}(typ.)+1V, V_{CE}=V_{DD}, Ta=25°C)

Item	Symbol	Measurement conditions	Min.	Typ.	Max.	Units
Input Current(OFF)	I _{DDoff}	V _{CE} =0V		0.01	1.0	μA
No-Load Input Current	I _{DD}	I _{OUT} =0mA		4.5	10	μA
GND PIN Current	I _{gnd}	I _{OUT} =5mA	12			μA
Output Voltage	V _{OUT}	I _{OUT} =30mA	×0.99		×1.01	V
Line Regulation	V _{LINE}	V _{DD} =V _O (typ.)+0.5~6V, I _{OUT} =30mA (V _{OUT} ≤1.6V, V _{DD} =2.2~6V)		0.01	0.2	%/V
Load Regulation	V _{LOAD}	1mA≤I _{OUT} ≤80mA		15	50	mV
Dropout Voltage	V _{io}	Please refer to another page				V
Ripple Rejection 1 (Note3)	RR1	f=1kHz, V _{ripple} =0.5V, I _{OUT} =30mA 1.5V≤V _{out} ≤4.0V		70		dB
Ripple Rejection 2 (Note3)	RR2	f=10kHz, V _{ripple} =0.5V, I _{OUT} =30mA 1.5V≤V _{out} ≤4.0V		55		dB
Ripple Rejection 3 (Note3)	RR3	f=1kHz, V _{ripple} =0.5V, I _{OUT} =30mA V _{OUT} ≥4.0V		45		dB
Ripple Rejection 4 (Note3)	RR4	f=10kHz, V _{ripple} =0.5V, I _{OUT} =30mA V _{OUT} ≥4.0V		35		dB
V _{OUT} Temperature Coefficient (Note3)	ΔV _{OUT} /ΔT	I _{OUT} =30mA -40≤T _{OP} ≤85°C		±100		ppm/°C
Output Short-circuit Current	I _{lim}	V _{OUT} =0V		50		mA
CE High Threshold Voltage	V _{CEH}		1.5			V
CE Low Threshold Voltage	V _{CEL}				0.25	V
CE High Threshold Current	I _{CEH}		-0.1		0.1	μA
CE Low Threshold Current	I _{CEL}		-0.1		0.1	μA

Note3 : The parameter is guaranteed by design.

• Any products mentioned in this catalog are subject to any modification in their appearance and others for improvements without prior notification.
 • The details listed here are not a guarantee of the individual products at the time of ordering. When using the products, you will be asked to check their specifications.

Electrical Characteristics 2 (Except where noted otherwise $V_{DD}=V_{OUT}(typ.)+1V$, $V_{CE}=V_{DD}$, $T_a=25^{\circ}C$)

Model No.	Item											
	Output Voltage				Dropout Voltage 1				Dropout Voltage 2			
	V_{OUT} (V)				V_{IO1} (V)				V_{IO2} (V)			
	Measurement Conditions	Min.	Typ.	Max.	Measurement Conditions	Min.	Typ.	Max.	Measurement Conditions	Min.	Typ.	Max.
MM3361F	$I_{OUT}=30mA$	1.485	1.500	1.515	$I_{OUT}=30mA$ $1.5V \leq V_{OUT} \leq 1.9V$				$I_{OUT}=100mA$ $1.5V \leq V_{OUT} \leq 1.9V$			
MM3361G		1.584	1.600	1.616								
MM3361H		1.683	1.700	1.717								
MM3361J		1.782	1.800	1.818								
MM3361K		1.881	1.900	1.919								
MM3362A		1.980	2.000	2.020	$2.0V \leq V_{OUT} \leq 2.4V$				$2.0V \leq V_{OUT} \leq 2.4V$			
MM3362B		2.079	2.100	2.121								
MM3362C		2.178	2.200	2.222								
MM3362D		2.277	2.300	2.323								
MM3362E		2.376	2.400	2.424								
MM3362F		2.475	2.500	2.525	$2.5V \leq V_{OUT} \leq 2.9V$				$2.5V \leq V_{OUT} \leq 2.9V$			
MM3362G		2.574	2.600	2.626								
MM3362H		2.673	2.700	2.727								
MM3362J		2.772	2.800	2.828								
MM3362Y		2.822	2.850	2.879								
MM3362K	2.871	2.900	2.929									
MM3363A		2.970	3.000	3.030	$3.0V \leq V_{OUT} \leq 3.2V$				$3.0V \leq V_{OUT} \leq 3.2V$			
MM3363B		3.069	3.100	3.131								
MM3363C		3.168	3.200	3.232								
MM3363D		3.267	3.300	3.333	$3.3V \leq V_{OUT} \leq 5.0V$				$3.3V \leq V_{OUT} \leq 5.0V$			
MM3363E		3.366	3.400	3.434								
MM3363F		3.465	3.500	3.535								
MM3363G		3.564	3.600	3.636								
MM3363H		3.663	3.700	3.737								
MM3363J		3.762	3.800	3.838								
MM3363K		3.861	3.900	3.939								
MM3364A		3.960	4.000	4.040								
MM3364B		4.059	4.100	4.141								
MM3364C		4.158	4.200	4.242								
MM3364D		4.257	4.300	4.343								
MM3364E		4.356	4.400	4.444								
MM3364F		4.455	4.500	4.545								
MM3364G		4.554	4.600	4.646								
MM3364H		4.653	4.700	4.747								
MM3364J		4.752	4.800	4.848								
MM3364K	4.851	4.900	4.949									
MM3365A	4.950	5.000	5.050									

• Any products mentioned in this catalog are subject to any modification in their appearance and others for improvements without prior notification.
 • The details listed here are not a guarantee of the individual products at the time of ordering. When using the products, you will be asked to check their specifications.

Measuring Circuit

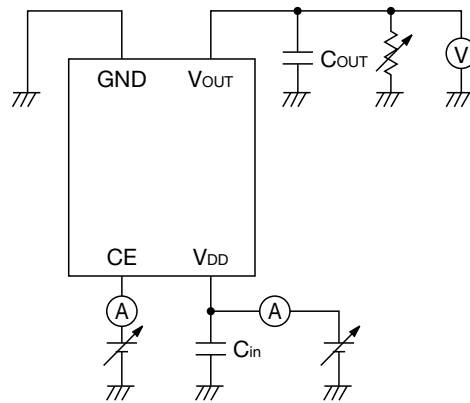

Application Circuit

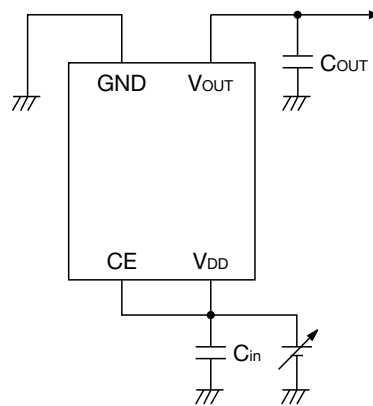

* Temperature Characteristics : B

(Reference example of external parts)

- Output capacitor Ceramic capacitor 1 μ F
- Input capacitor Ceramic capacitor 1 μ F

· Note

1. The output capacitor is required between output and GND to prevent oscillation.
2. The ESR of capacitor must be defined in ESR stability area.
It is possible to use a ceramic capacitor without ESR resistance for output.
The ceramic capacitor must be used more than 1 μ F and B temperature characteristics.
3. The wire of VCC and GND is required to print full ground plane for noise and stability.
4. The input capacitor must be connected a distance of less than 1cm from input pin.
5. In case the output voltage is above the input voltage, the overcurrent flow by internal parasitic diode from output to input.

Characteristics (Vo=1.5V) (Except where noted otherwise $V_{DD}=V_{OUT}$ (typ.) +1V, $V_{CE}=V_{DD}$, $T_a=25^\circ\text{C}$)

Output - Input voltage

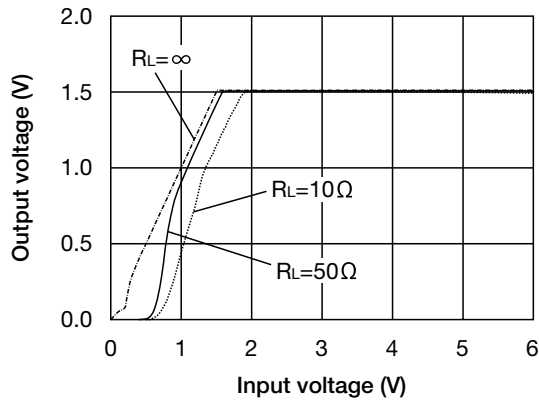

Input current - Input voltage

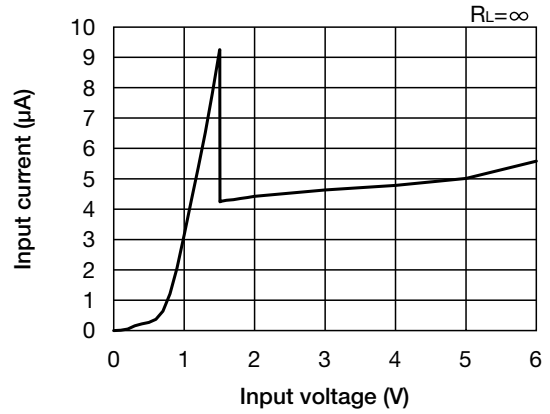

Load regulation

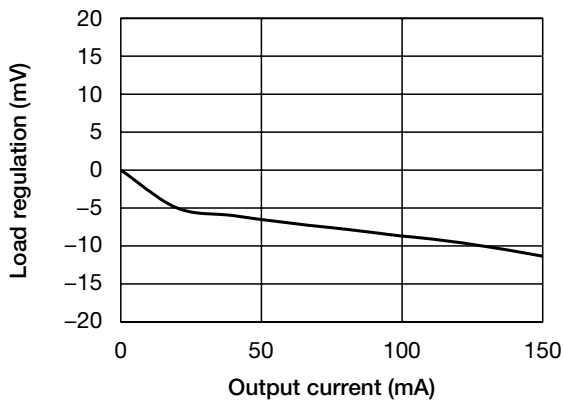

GND PIN Current

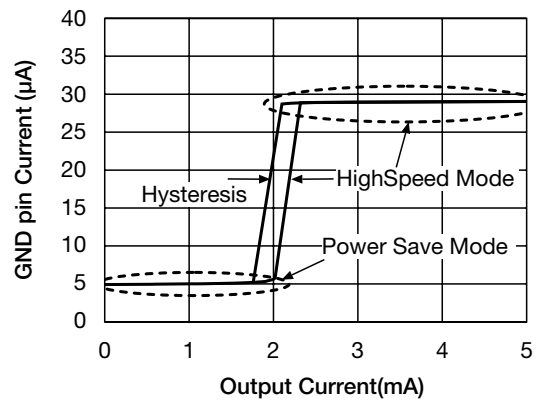

Dropout voltage - Output current

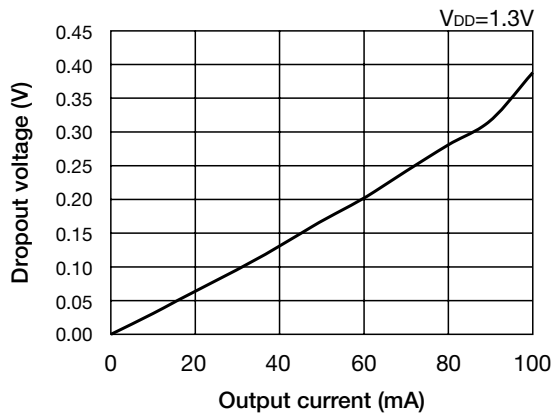

Line regulation

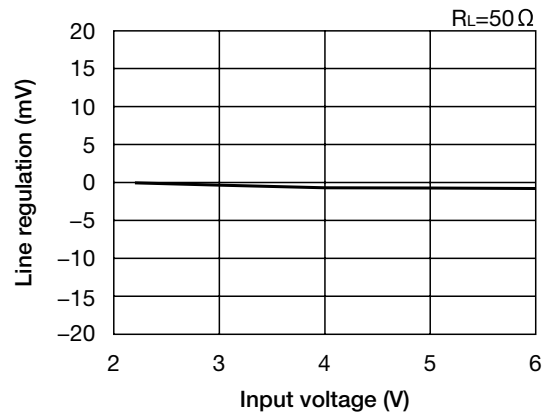

■ Load transient response ($I_o=0.1 \rightarrow 100\text{mA}$)

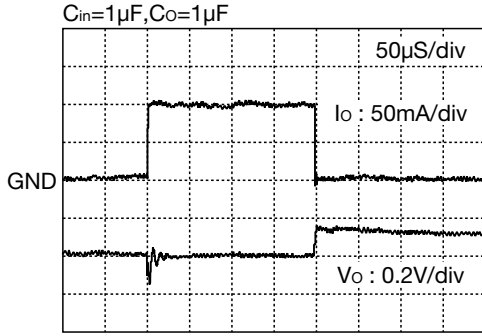

■ Load transient response ($I_o=0.1 \rightarrow 150\text{mA}$)

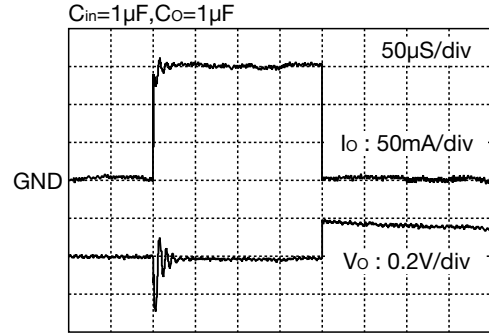

■ Load transient response ($I_o=5 \rightarrow 100\text{mA}$)

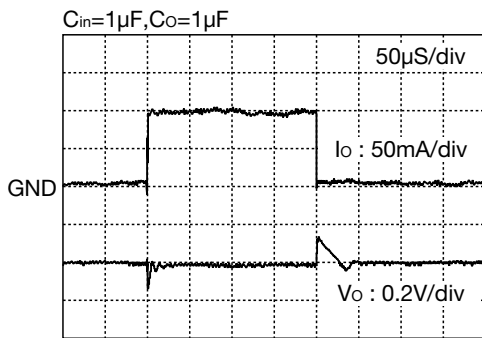

■ Load transient response ($I_o=5 \rightarrow 150\text{mA}$)

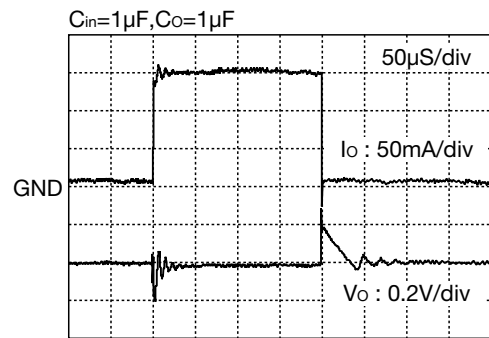

■ Ripple Rejection

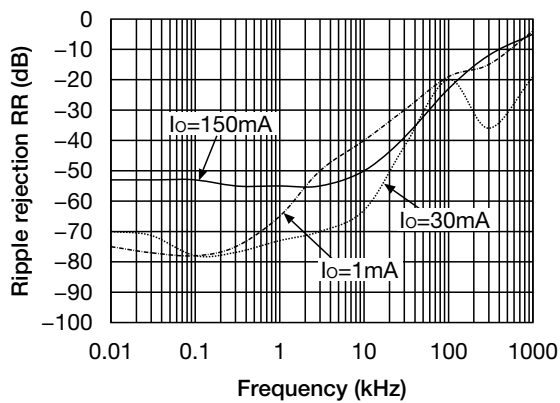

■ Current limit

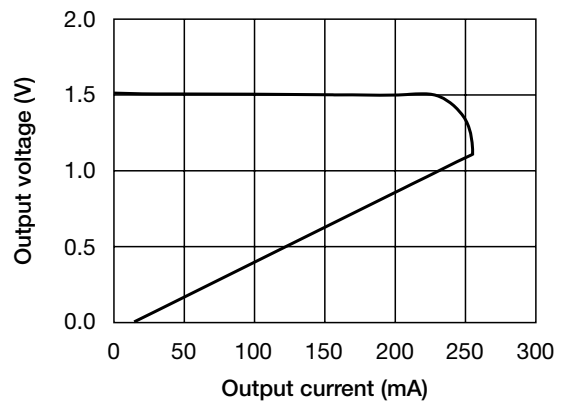

Characteristics (Vo=3.0V) (Except where noted otherwise $V_{DD}=V_{OUT}(\text{typ.}) + 1V$, $V_{CE}=V_{DD}$, $T_a=25^\circ\text{C}$)

Output - Input voltage

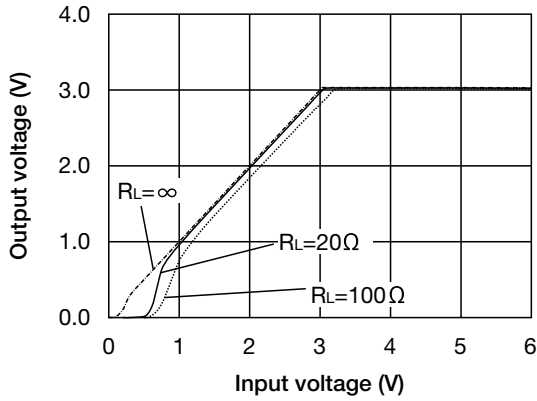

Input current - Input voltage

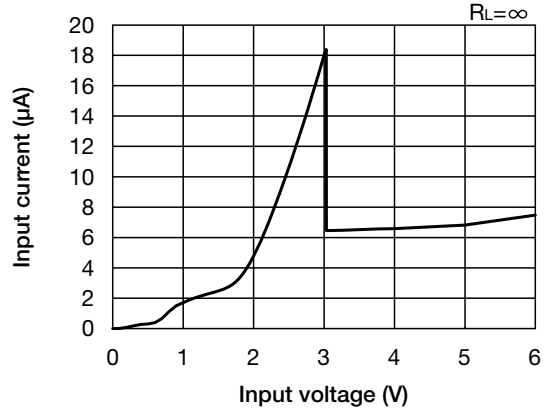

Load regulation

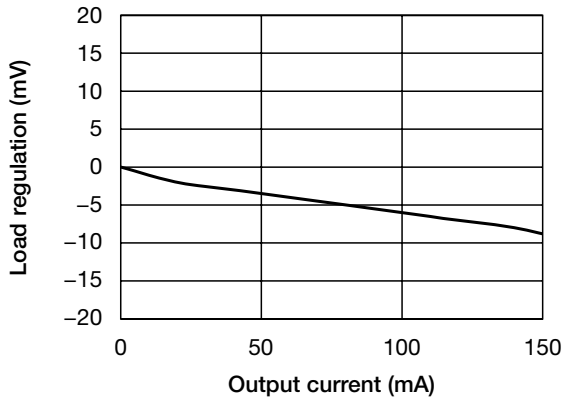

GND PIN Current

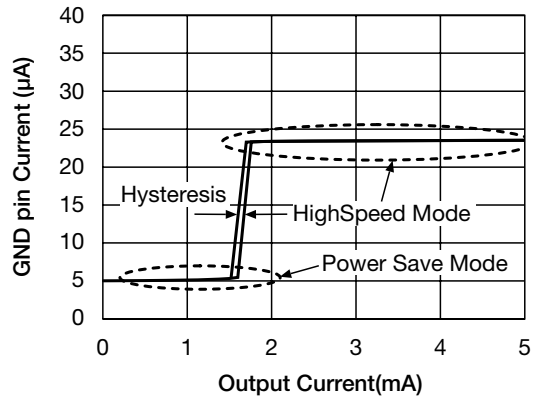

Dropout voltage - Output current

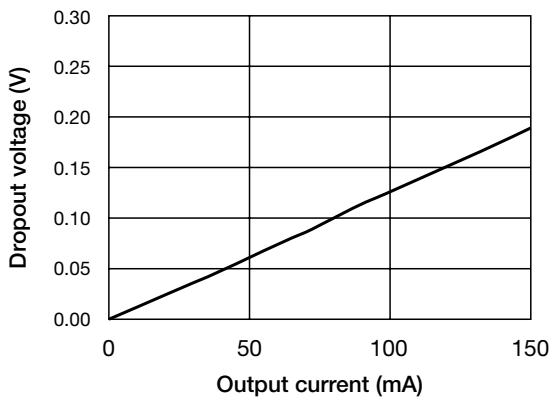

Line regulation

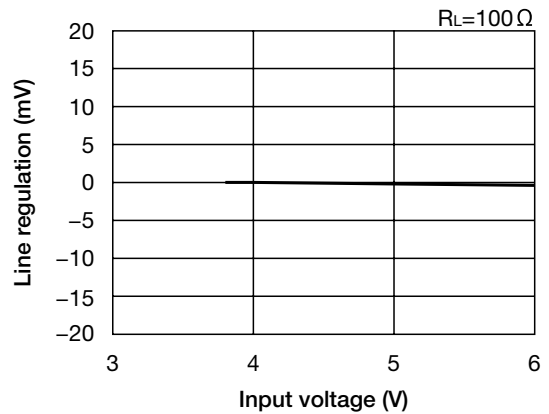

• Any products mentioned in this catalog are subject to any modification in their appearance and others for improvements without prior notification.
 • The details listed here are not a guarantee of the individual products at the time of ordering. When using the products, you will be asked to check their specifications.

■ Load transient response ($I_o=0.1 \rightarrow 100\text{mA}$)

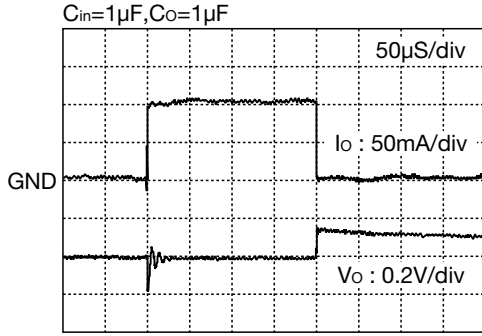

■ Load transient response ($I_o=0.1 \rightarrow 150\text{mA}$)

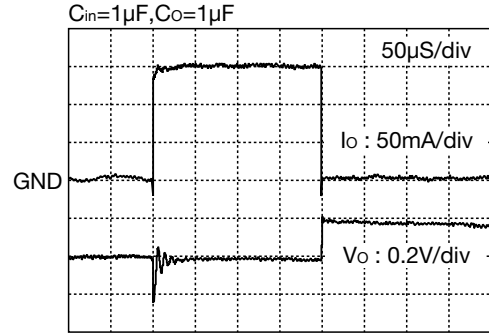

■ Load transient response ($I_o=5 \rightarrow 100\text{mA}$)

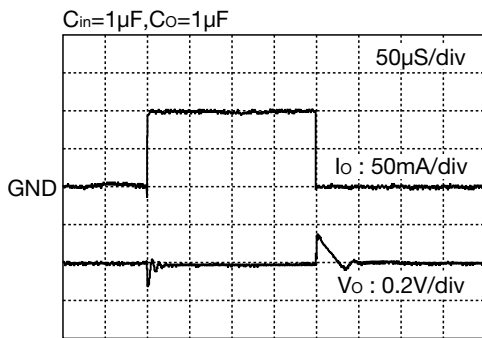

■ Load transient response ($I_o=5 \rightarrow 150\text{mA}$)

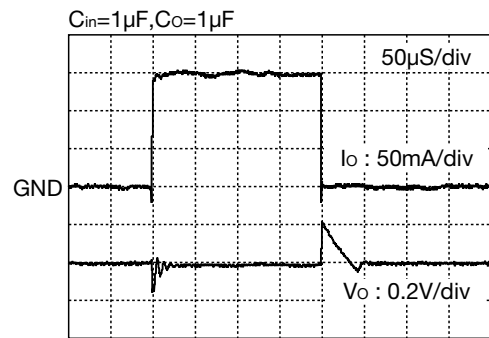

■ Ripple Rejection

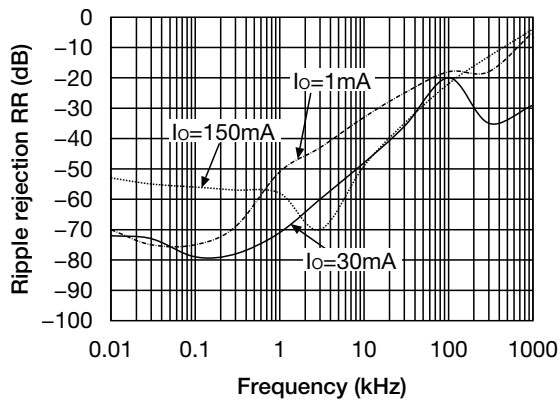

■ Output voltage - Temperature

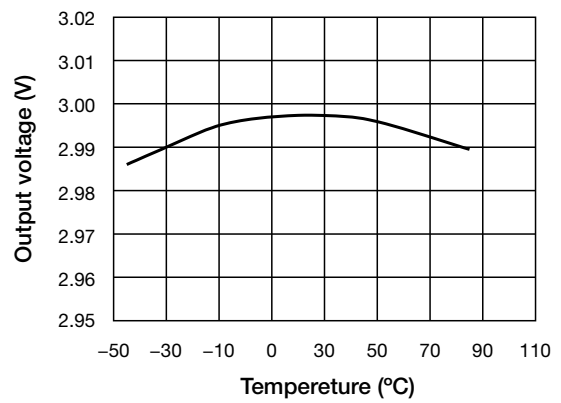

■ Current limit

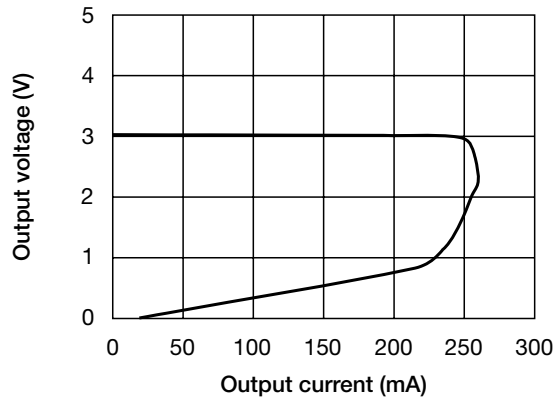

Characteristics (Vo=5.0V) (Except where noted otherwise $V_{DD}=V_{OUT} (typ.) + 1V$, $V_{CE}=V_{DD}$, $T_a=25^{\circ}C$)

Output - Input voltage

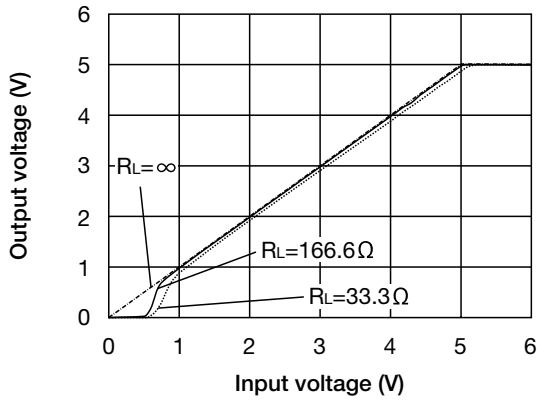

Input current - Input voltage

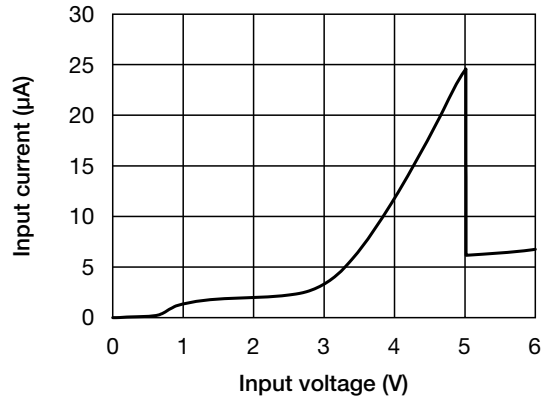

Load regulation

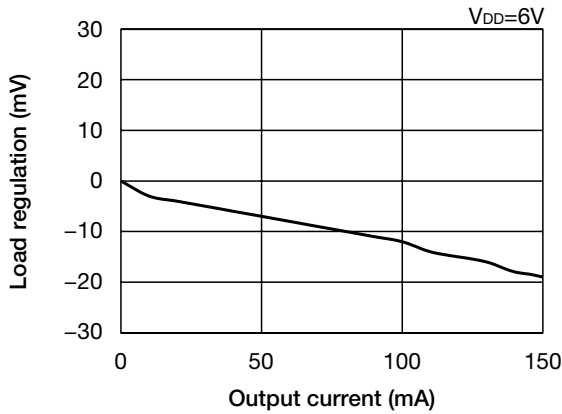

GND PIN Current

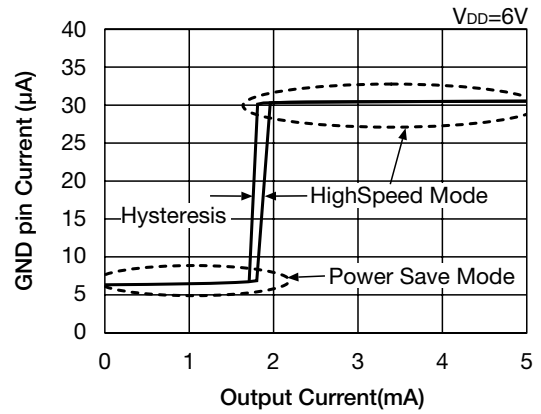

Dropout voltage - Output current

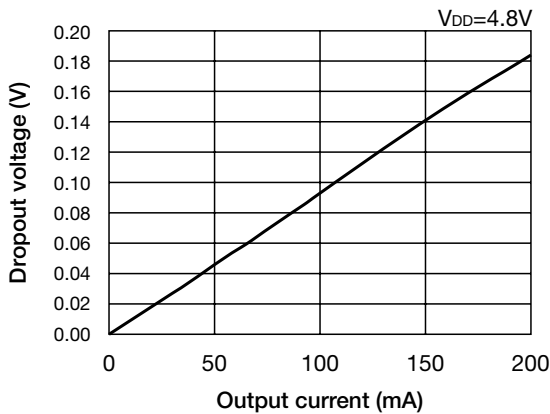

Line regulation

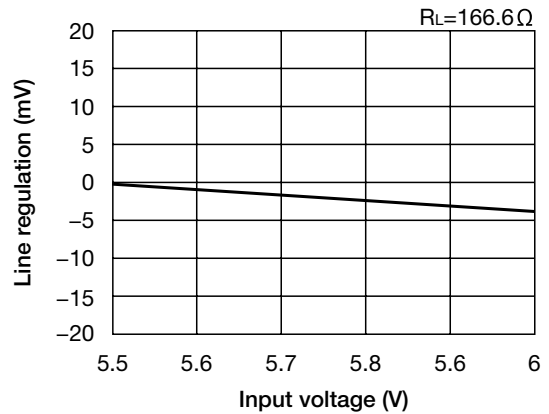

• Any products mentioned in this catalog are subject to any modification in their appearance and others for improvements without prior notification.
 • The details listed here are not a guarantee of the individual products at the time of ordering. When using the products, you will be asked to check their specifications.

■ Load transient response ($I_o=0.1 \rightarrow 100\text{mA}$)

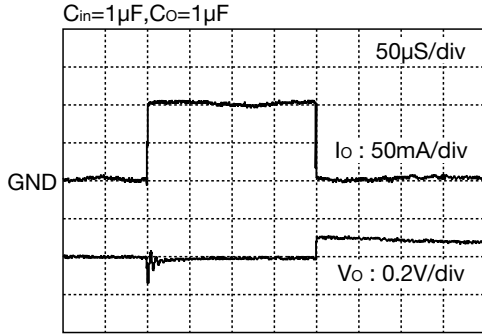

■ Load transient response ($I_o=0.1 \rightarrow 150\text{mA}$)

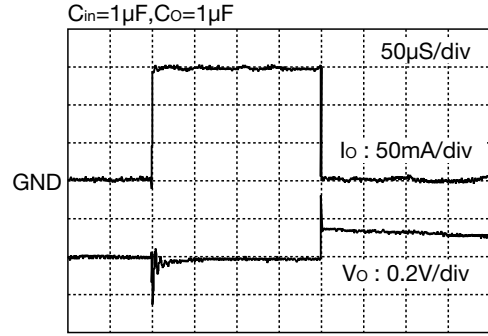

■ Load transient response ($I_o=5 \rightarrow 100\text{mA}$)

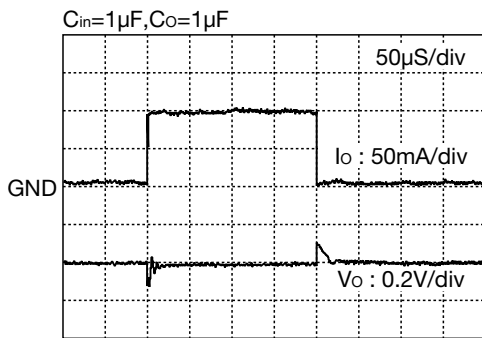

■ Load transient response ($I_o=5 \rightarrow 150\text{mA}$)

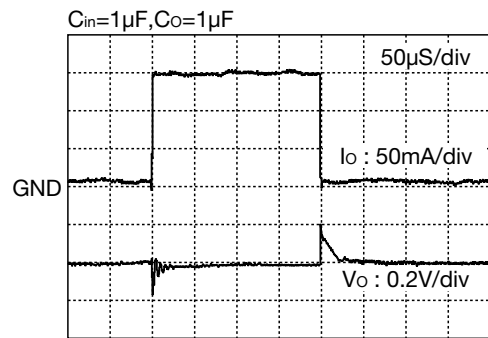

■ Ripple Rejection

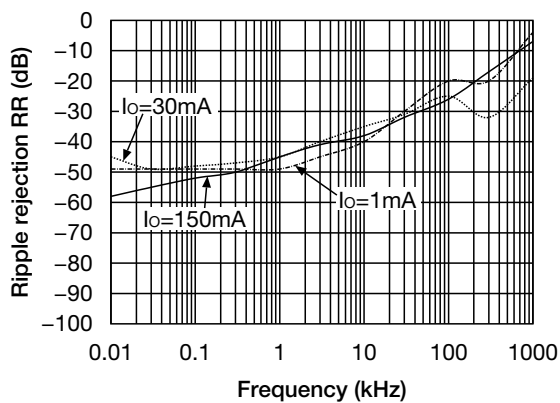

■ Current limit

