

150mA CMOS Voltage Regulator IC

Monolithic IC MM3376AX Series

Outline

This IC is a regulator IC providing low supply current (1.7μA) and low input voltage (1.2~6V), developed using the CMOS process, and supports longer battery life with a chip enable function. In addition, it is ideal to be used for a constant voltage power supply for backup as it includes a reverse current protection function to automatically prevent a current (0.1μA max.) from reversely flowing to the input terminal side if a voltage exceeding the input terminal voltage (V_{DD}) is applied to the output terminal (V_{OUT}) by monitoring the voltages of the output terminal (V_{OUT}) and input terminal (V_{DD}).

Features

1. Input voltage range	1.2~6V
2. Output voltage range	0.8~5.0V
3. Output voltage accuracy	$V_{OUT} \pm 2\%$
4. Maximum output current	150mA
5. Supply current	1.7μA typ. (No-Load Input Current) 0.6μA typ. (OFF)
6. Reverse current	0.1μA max.
7. Output capacitor	0.1μF
8. Dropout voltage	30mV typ. / 50mV max. ($I_o=10mA$ $3.3V \leq V_{OUT} \leq 5.0V$)
9. Output short-circuit current	60mA typ.
10. Line regulation	0.05%V typ. ($I_o=1mA$)
11. Load regulation	30mV typ. / 90mV max. ($I_o=1\sim 150mA$)

Package

SOT-25A
SSON-4
SC-82

Applications

1. Cellular Phones
2. Portable Games
3. PDAs
4. Digital still Cameras
5. Note PCs

Block Diagram

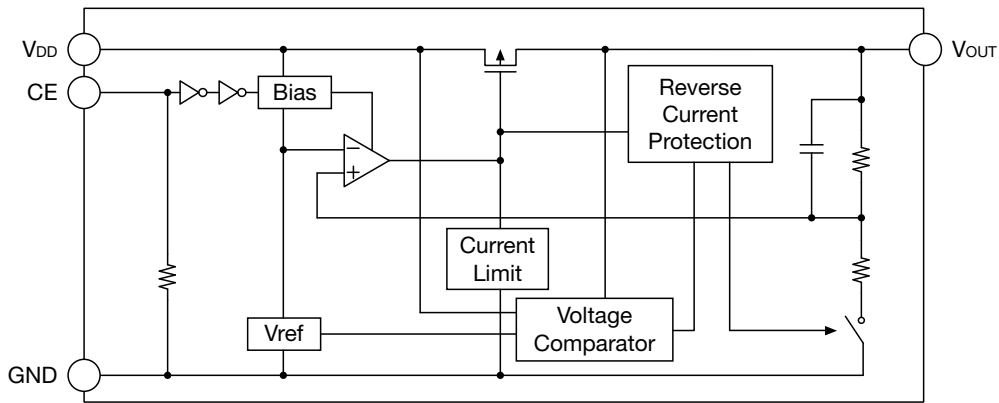

Pin Assignment

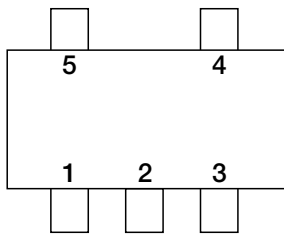

SOT-25A
(TOP VIEW)

1	V _{DD}
2	GND
3	CE
4	NC
5	V _{OUT}

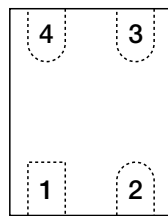

SSON-4
(TOP VIEW)

1	GND
2	CE
3	V _{DD}
4	V _{OUT}

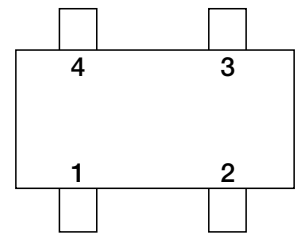

SC-82
(TOP VIEW)

1	CE
2	GND
3	V _{OUT}
4	V _{DD}

Pin Description

SOT-25A

Pin No.	Pin name	Functions						
1	V _{DD}	Voltage-supply pin						
2	GND	Ground pin						
3	CE	ON/OFF-Control pin						
		<table border="1"> <thead> <tr> <th>CE</th> <th>OUTPUT</th> </tr> </thead> <tbody> <tr> <td>Low</td> <td>OFF</td> </tr> <tr> <td>High</td> <td>ON</td> </tr> </tbody> </table>	CE	OUTPUT	Low	OFF	High	ON
		CE	OUTPUT					
		Low	OFF					
High	ON							
Connect CE pin with V _{DD} pin, when it is not used.								
4	NC	No connection						
5	V _{OUT}	Output pin						

SSON-4

Pin No.	Pin name	Functions						
1	GND	Ground pin						
2	CE	ON/OFF-Control pin						
		<table border="1"> <thead> <tr> <th>CE</th> <th>OUTPUT</th> </tr> </thead> <tbody> <tr> <td>Low</td> <td>OFF</td> </tr> <tr> <td>High</td> <td>ON</td> </tr> </tbody> </table>	CE	OUTPUT	Low	OFF	High	ON
		CE	OUTPUT					
		Low	OFF					
High	ON							
Connect CE pin with V _{DD} pin, when it is not used.								
3	V _{DD}	Voltage-supply pin						
4	V _{OUT}	Output pin						

SC-82

Pin No.	Pin name	Functions						
1	CE	ON/OFF-Control pin						
		<table border="1"> <thead> <tr> <th>CE</th> <th>OUTPUT</th> </tr> </thead> <tbody> <tr> <td>Low</td> <td>OFF</td> </tr> <tr> <td>High</td> <td>ON</td> </tr> </tbody> </table>	CE	OUTPUT	Low	OFF	High	ON
		CE	OUTPUT					
		Low	OFF					
High	ON							
Connect CE pin with V _{DD} pin, when it is not used.								
2	GND	Ground pin						
3	V _{OUT}	Output pin						
4	V _{DD}	Voltage-supply pin						

Absolute Maximum Ratings (Except where noted otherwise Ta=25°C)

Item	Symbol	Ratings	Units
Storage temperature	T _{STG}	-55~+150	°C
Supply voltage	V _{DD}	6.5	V
CE input voltage	V _{CE}	-0.3~6.5	V
Output voltage	V _{OUT}	-0.3~6.5	V
Output current	I _{OUT}	200	mA
Power dissipation	Pd	350(Note1) (SOT-25A)	mW
		330(Note2) (SSON-4B)	
		240(Note3) (SC-82ABB)	

Note1 : With PC Board of glass epoxy.

Note2 : With PC Board of glass epoxy 110 × 40 × 0.8^tmm

Note3 : With PC Board of glass epoxy (The tab pin is not connected with PC Board.) 100 × 100 × 1.6^tmm

Recommended Operating Conditions (Except where noted otherwise Ta=25°C)

Item	Symbol	Ratings	Units
Operating ambient temperature	T _{JOP}	-40~85	°C
Operating voltage	V _{OP}	V _O +0.3~6	V
Output current	I _{OUT}	0~150	mA

Electrical Characteristics 1 (Except where noted otherwise $V_{DD}=V_o(\text{typ.})+1V$, $V_{CE}=V_{DD}$, $T_a=25^\circ\text{C}$)

Item	Symbol	Measurement conditions	Min.	Typ.	Max.	Units
Input current (OFF)	I_{DDoff}	$V_{CE}=0V$		0.6	1.2	μA
No-load input current	I_{DD}	$I_{OUT}=0\text{mA}$		1.7	3.5	μA
Output voltage	V_{OUT}	$I_{OUT}=1\text{mA}$	$\times 0.98$		$\times 1.02$	V
Line regulation	V_{LINE}	$I_{OUT}=1\text{mA}$ $V_{OUT}(\text{typ.})+1V \leq V_{DD} \leq 6V$		0.05	0.20	%/V
Load regulation	V_{LOAD}	$1\text{mA} \leq I_{OUT} \leq 150\text{mA}$		30	90	mV
Dropout voltage	V_{io}	Please refer to another page				V
Output short-circuit current (Note4)	I_{lim}	$V_{OUT}=0V$		60		mA
V_{OUT} temperature coefficient (Note4)	$\Delta V_{OUT} / \Delta T_{OP}$	$I_{OUT}=30\text{mA}$ $-40 \leq T_{OP} \leq 85^\circ\text{C}$		± 100		ppm/ $^\circ\text{C}$
CE pin current	I_{CE}			0.5		μA
CE H threshold voltage	V_{CEH}		1.0		V_{DD}	V
CE L threshold voltage	V_{CEL}		0		0.3	V
Reverse current	I_{REV}	$V_{OUT}>0.5V, 0V \leq V_{DD} \leq 6V$			0.1	μA

Note4 : The item is guaranteed by design.

Electrical Characteristics 2 (Except where noted otherwise $V_{DD}=V_{OUT}(typ.)+1V$, $V_{CE}=V_{DD}$, $T_a=25^{\circ}C$)

Model No.	Item							
	Output voltage				Dropout voltage			
	V_{OUT} (V)				V_{io} (V)			
	Measurement conditions	Min.	Typ.	Max.	Measurement conditions	Min.	Typ.	Max.
MM3376A08NRE	$I_{OUT}=1mA$	0.770	0.8	0.830	(Note5)			
MM3376A09NRE		0.870	0.9	0.930				
MM3376A10NRE		0.970	1.0	1.030				
MM3376A11NRE		1.070	1.1	1.130				
MM3376A12NRE		1.170	1.2	1.230				
MM3376A13NRE		1.270	1.3	1.330				
MM3376A14NRE		1.370	1.4	1.430				
MM3376A15NRE		1.470	1.5	1.530				
MM3376A16NRE		1.568	1.6	1.632	$I_{OUT}=10mA$ $1.5V \leq V_{OUT} \leq 1.9V$	0.12	0.15	
MM3376A17NRE		1.666	1.7	1.734				
MM3376A18NRE		1.764	1.8	1.836				
MM3376A19NRE		1.862	1.9	1.938				
MM3376A20NRE		1.960	2.0	2.040	$I_{OUT}=10mA$ $2.0V \leq V_{OUT} \leq 2.4V$ $V_{DD}=V_{OUT}-0.2V$	0.08	0.12	
MM3376A21NRE		2.058	2.1	2.142				
MM3376A22NRE		2.156	2.2	2.244				
MM3376A23NRE		2.254	2.3	2.346				
MM3376A24NRE		2.352	2.4	2.448	$I_{OUT}=10mA$ $2.5V \leq V_{OUT} \leq 2.9V$ $V_{DD}=V_{OUT}-0.2V$	0.06	0.08	
MM3376A25NRE		2.450	2.5	2.550				
MM3376A26NRE		2.548	2.6	2.652				
MM3376A27NRE		2.646	2.7	2.754				
MM3376A28NRE		2.744	2.8	2.856	$I_{OUT}=10mA$ $3.0V \leq V_{OUT} \leq 3.2V$ $V_{DD}=V_{OUT}-0.2V$	0.05	0.07	
MM3376A29NRE		2.842	2.9	2.958				
MM3376A30NRE		2.940	3.0	3.060				
MM3376A31NRE		3.038	3.1	3.162				
MM3376A32NRE		3.136	3.2	3.264	$I_{OUT}=10mA$ $3.3V \leq V_{OUT} \leq 5.0V$ $V_{DD}=V_{OUT}-0.2V$	0.03	0.05	
MM3376A33NRE		3.234	3.3	3.366				
MM3376A34NRE		3.332	3.4	3.468				
MM3376A35NRE		3.430	3.5	3.570				
MM3376A36NRE		3.528	3.6	3.672				
MM3376A37NRE		3.626	3.7	3.774				
MM3376A38NRE		3.724	3.8	3.876				
MM3376A39NRE		3.822	3.9	3.978				
MM3376A40NRE	3.920	4.0	4.080					
MM3376A41NRE	4.018	4.1	4.182					
MM3376A42NRE	4.116	4.2	4.284					
MM3376A43NRE	4.214	4.3	4.386					
MM3376A44NRE	4.312	4.4	4.488					
MM3376A45NRE	4.410	4.5	4.590					
MM3376A46NRE	4.508	4.6	4.692					
MM3376A47NRE	4.606	4.7	4.794					
MM3376A48NRE	4.704	4.8	4.896					
MM3376A49NRE	4.802	4.9	4.998					
MM3376A50NRE	4.900	5.0	5.100					

Note5 : The item is not guaranteed in the model less than $V_{OUT}=1.4V$.

• Any products mentioned in this catalog are subject to any modification in their appearance and others for improvements without prior notification.
 • The details listed here are not a guarantee of the individual products at the time of ordering. When using the products, you will be asked to check their specifications.

Measuring Circuit

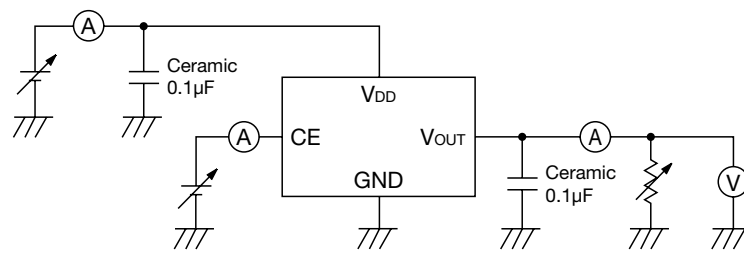

Basic Measuring Circuit

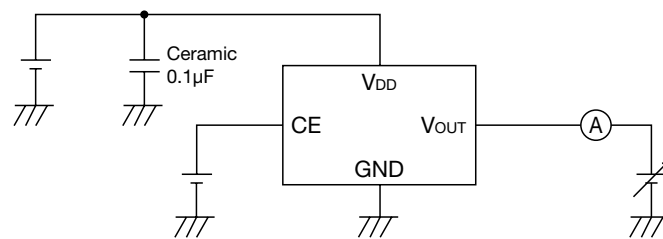

Reverse Current Measuring Circuit

Application Circuit

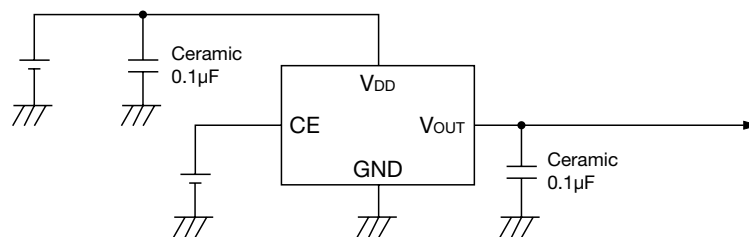

· Note

1. The output capacitor is required between output and GND to prevent oscillation.
2. The ESR of capacitor must be defined in ESR stability area.
It is possible to use a ceramic capacitor without ESR resistance for output.
The ceramic capacitor must be used more than 0.1μF and B temperature characteristics.
3. The wire of V_{CC} and GND is required to print full ground plane for noise and stability.
4. The input capacitor must be connected a distance of less than 1cm from input pin.
5. Be careful because it becomes easy to overshoot output voltage at the time of input voltage starting when an output capacitance is smaller than 0.47μF.

Timing Chart

1) Reverse current mode

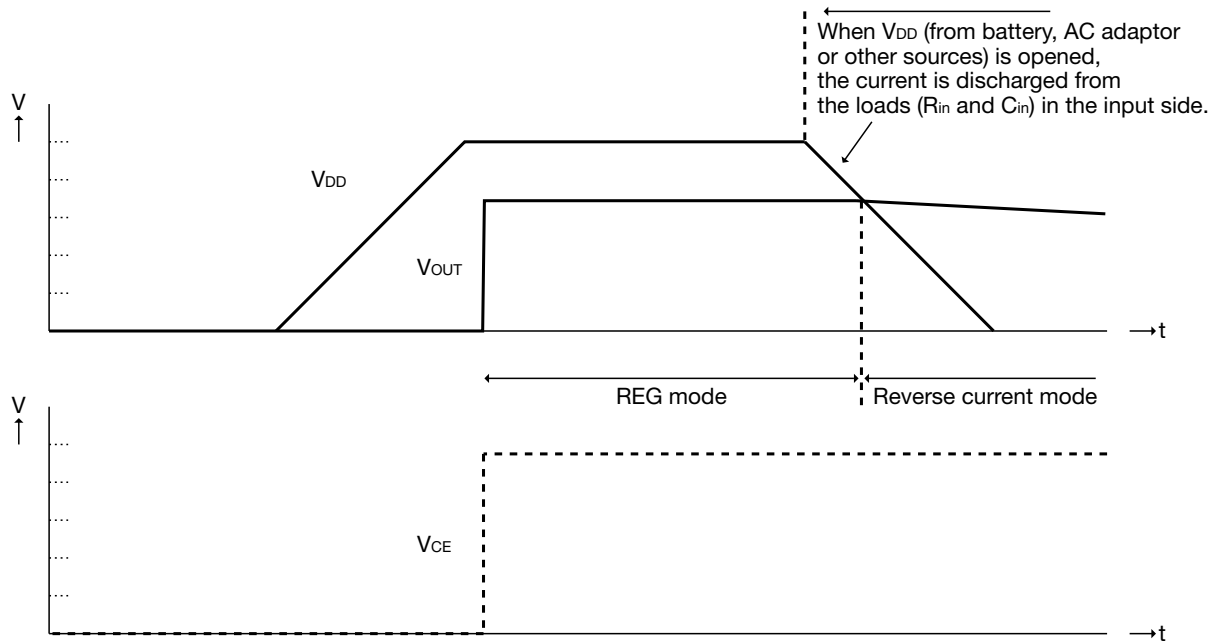

2) During the input voltage build-up

When V_{CE} terminal is shorted to V_{DD} .

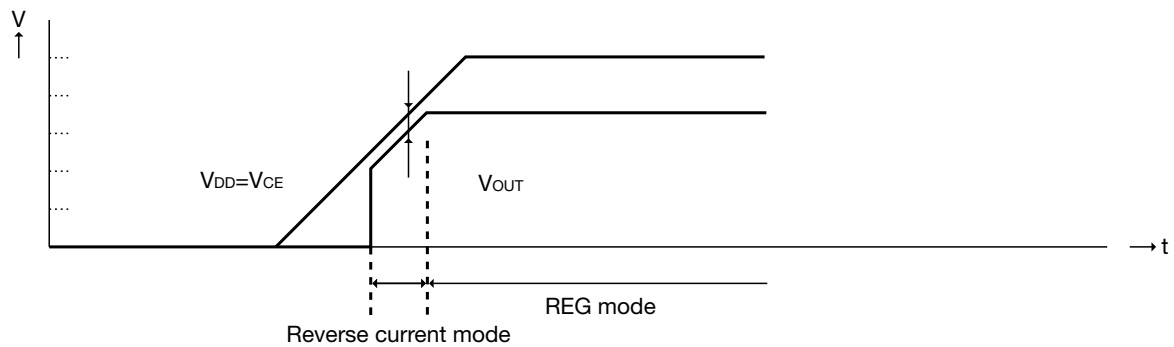

While voltage is building up in the input side, this IC operates in the reverse current mode when ΔV (Difference between input and output voltages) is 30mV (Reverse current mode threshold voltage) or less.

Characteristics (Vo=1.1V) (Except where noted otherwise Ta=25°C, VDD=VOUT (typ.) +1V, VCE=VDD, Cin=0.1µF, Co=0.1µF)

Input voltage - Output voltage

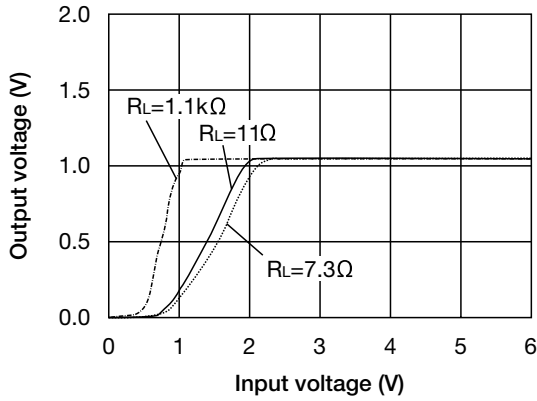

Input current - Input voltage

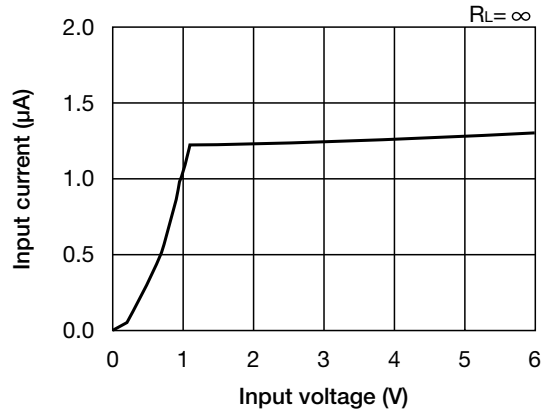

Load regulation

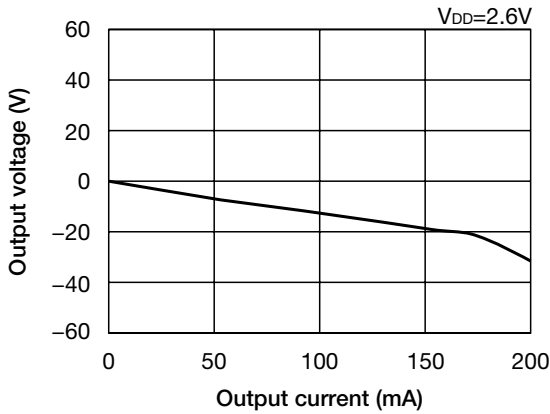

Line regulation

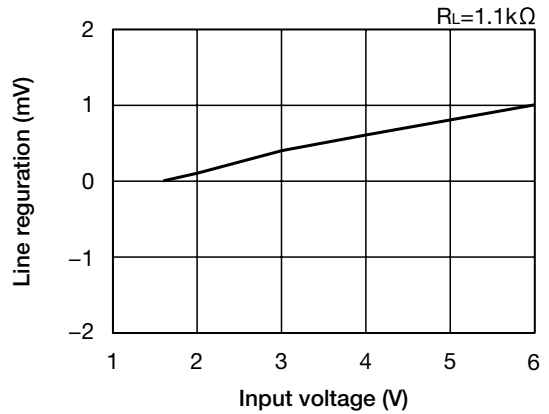

Temperature - output voltage

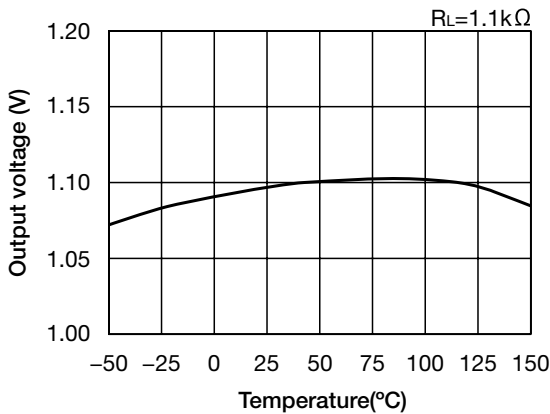

Ripple rejection

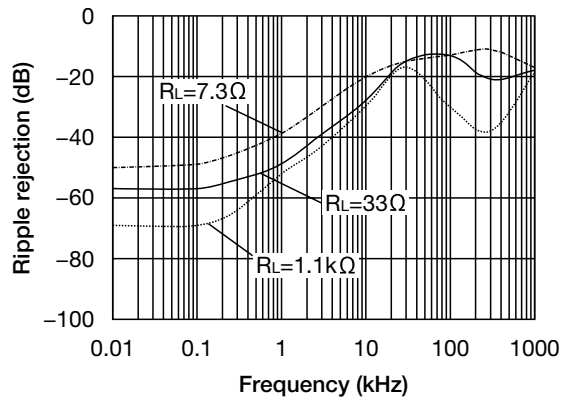

• Any products mentioned in this catalog are subject to any modification in their appearance and others for improvements without prior notification.
 • The details listed here are not a guarantee of the individual products at the time of ordering. When using the products, you will be asked to check their specifications.

Characteristics (Vo=3.3V) (Except where noted otherwise Ta=25°C, VDD=VOUT (typ.) +1V, VCE=VDD, Cin=0.1µF, Co=0.1µF)

Input voltage - Output voltage

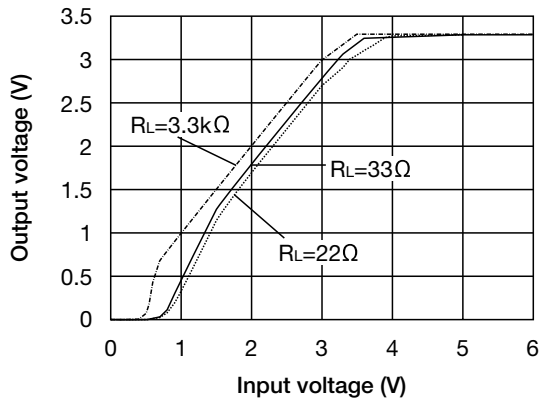

Input current - Input voltage

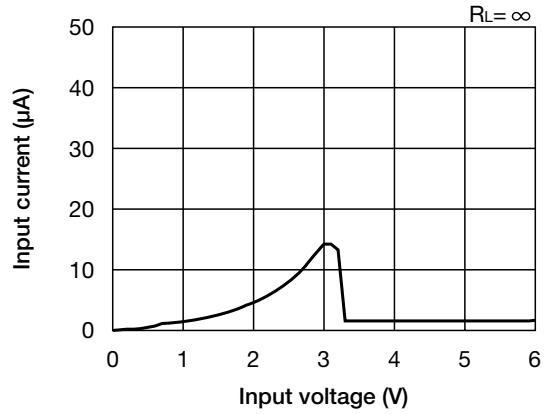

Load regulation

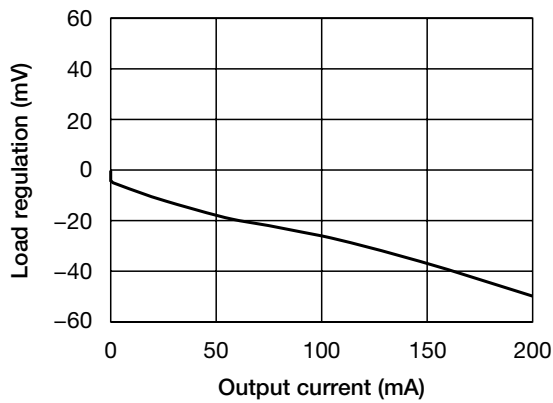

Line regulation

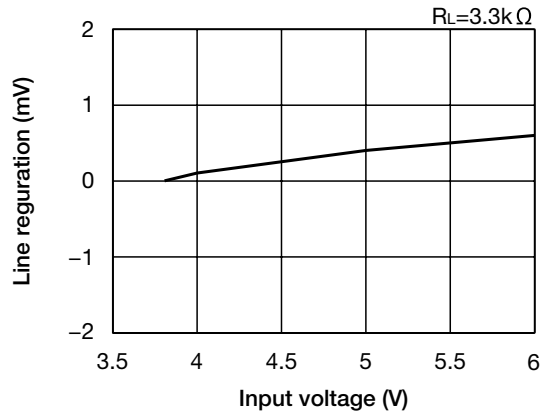

Temperature - output voltage

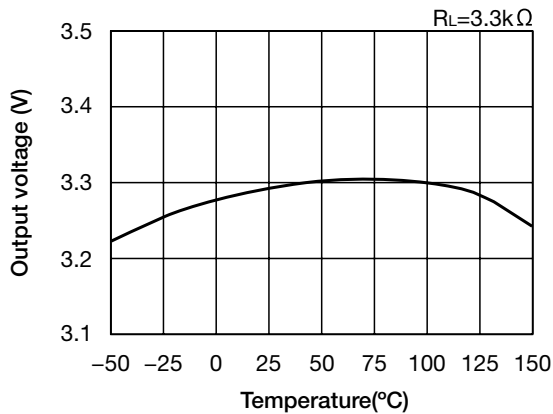

Ripple rejection

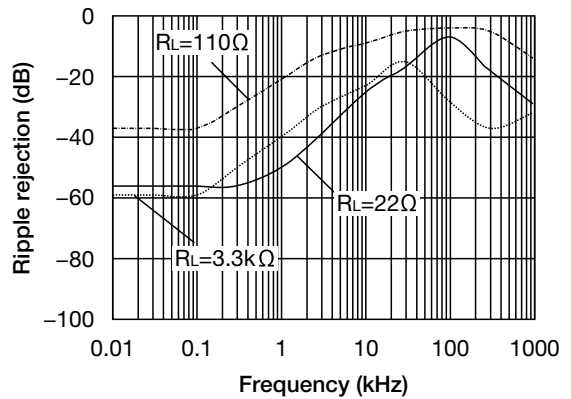

• Any products mentioned in this catalog are subject to any modification in their appearance and others for improvements without prior notification.
 • The details listed here are not a guarantee of the individual products at the time of ordering. When using the products, you will be asked to check their specifications.

Characteristics (Vo=3.3V) (Except where noted otherwise Ta=25°C, VDD=VOUT (typ.) +1V, VCE=VDD, Cin=0.1μF, Co=0.1μF)

Dropout voltage

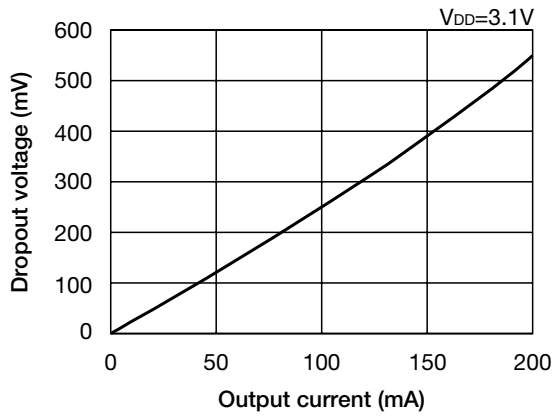

Current limit

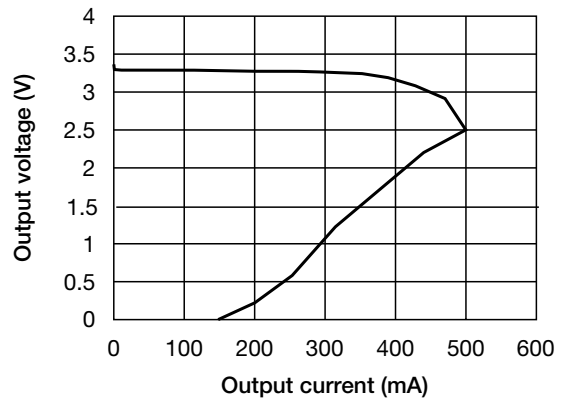

GND pin current

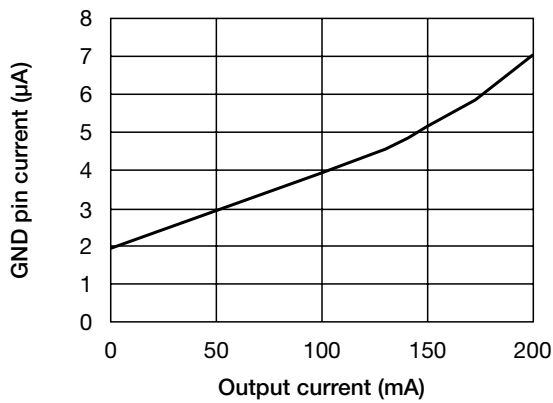

ESR stable area

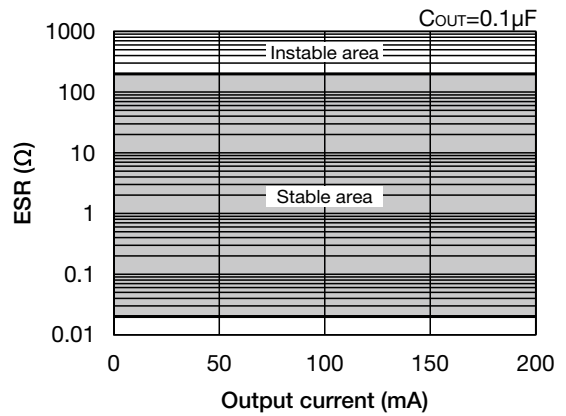

Reverse current characteristics

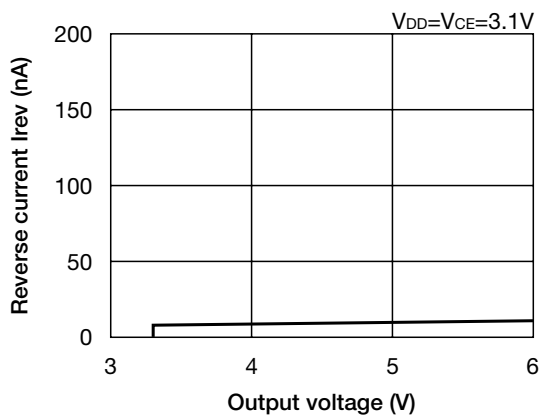

Characteristics (Vo=5.0V) (Except where noted otherwise Ta=25°C, VDD=VOUT (typ.) +1V, VCE=VDD, Cin=0.1µF, Co=0.1µF)

Input voltage - Output voltage

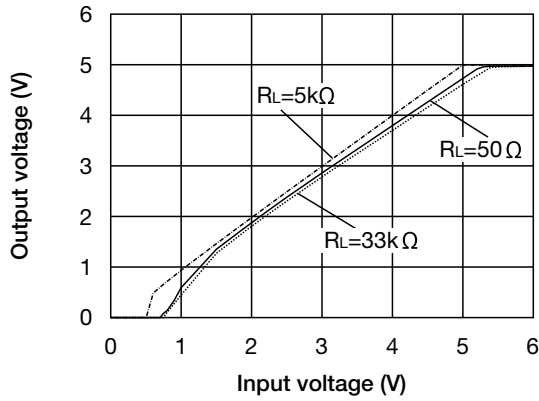

Input current - Input voltage

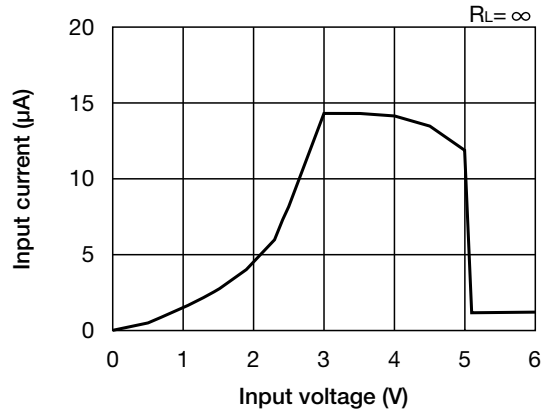

Load regulation

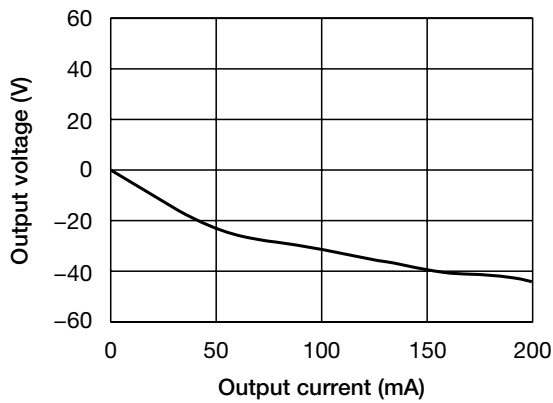

Line regulation

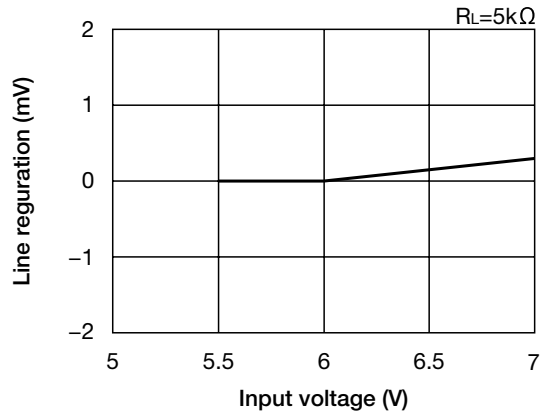

Temperature - output voltage

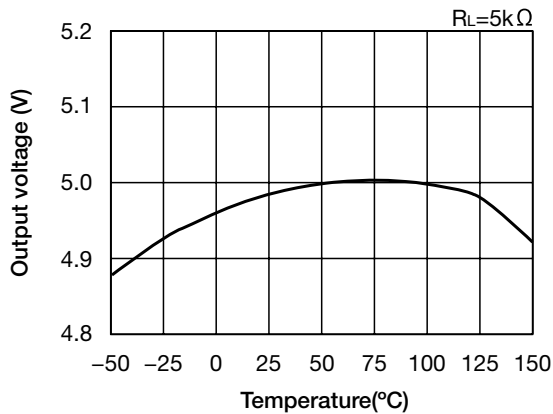

Ripple rejection

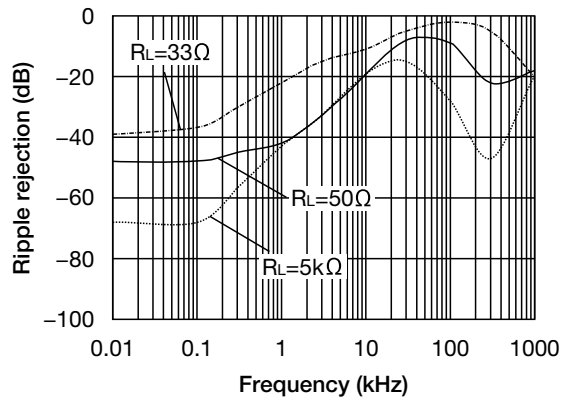

• Any products mentioned in this catalog are subject to any modification in their appearance and others for improvements without prior notification.
 • The details listed here are not a guarantee of the individual products at the time of ordering. When using the products, you will be asked to check their specifications.