

# 12-24GHz Frequency Multiplier

## GaAs Monolithic Microwave IC

### Description

The CHX2090 is a cascaded by 2 frequency multiplier monolithic circuit.

It is designed for a wide range of applications, from military to commercial communication systems. The backside of the chip is both RF and DC grounds. This helps simplify the assembly process.

The circuit is manufactured with a pHEMT process, 0.25µm gate length, via holes through the substrate, air bridges and electron beam gate lithography.

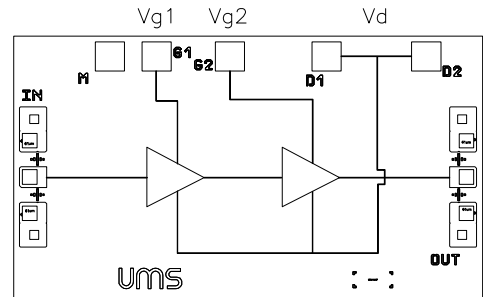

typical measurements

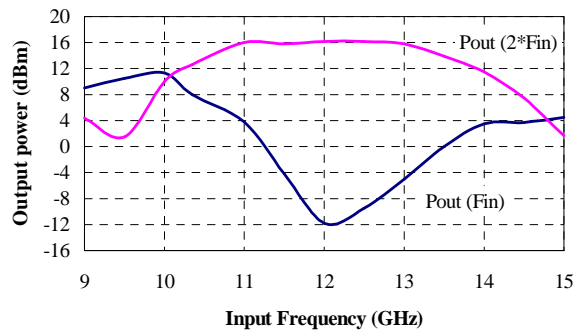

### Main Features

- Broadband performances: 11-13GHz
- 15dBm output power for +12dBm input power
- DC bias: Vd=3.5Volt@Id=50mA
- Chip size: 1.67 x 0.97 x 0.10mm

### Main Characteristics

Tamb. = 25°C

Symbol	Parameter	Min	Typ	Max	Unit
Fin	Input frequency range	11		13	GHz
Fout	Output frequency range	22		26	GHz
Pin	Input power	6	12		dBm
Pout	Output power for +12dBm input power	13	15		dBm

ESD Protection : Electrostatic discharge sensitive device. Observe handling precautions !

## Electrical Characteristics

Tamb = +25°C, Vd = 3.5V , Vg1 = -0.9V , Vg2 = -0.4V .

Symbol	Parameter	Min	Typ	Max	Unit
Fin	Input frequency range	11		13	GHz
Fout	Output frequency range	22		26	GHz
Pin	Input power	6	12		dBm
Pout	Output power for +12dBm input power	11	15		dBm
Is/Fo	Fin level at the output ( 11.5 < Fin < 13)		-10	-4	dBm
VSWRin	Input VSWR			2.0:1	
VSWRout	Output VSWR			2.5:1	
Id	Bias current		50	70	mA

## Absolute Maximum Ratings

Tamb. = 25°C (1)

Symbol	Parameter	Values	Unit
Vd	Drain bias voltage	5V	V
Id	Drain bias current	120	mA
Vg	Gate bias voltage	-2 to +0.4	V
Ta	Operating temperature range	-40 to +85	°C
Tstg	Storage temperature range	-55 to +155	°C

(1) Operation of this device above any one of these parameters may cause permanent damage.

**Typical on Jig Measurements.**

Bias conditions:  $V_d = 3.5V$  ,  $V_{g1} = -0.9V$  ,  $V_{g2} = -0.4V$ .

**Pout = f(Fin) for Pin=12 dBm.**

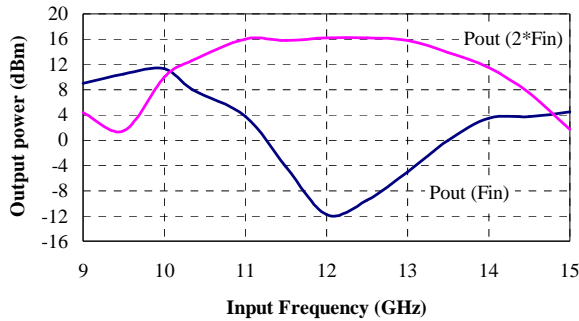

**S11 and S22 = f(Fin) for Pin = 0 dBm.**

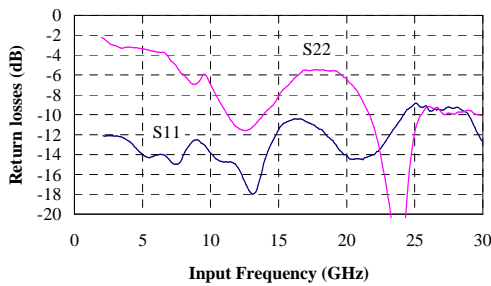

**Pout = f(Pin) for Fin = 11.5 GHz.**

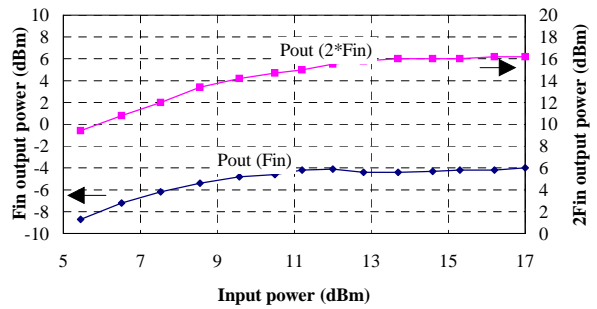

**Pout = f(Vg2) for Pin = 10 dBm and Fin = 11.5 Ghz.**

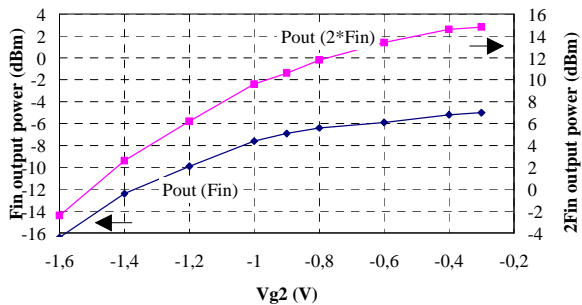

**Pout = f(Vg2) for Pin=14 dBm and Fin = 11.5 Ghz.**

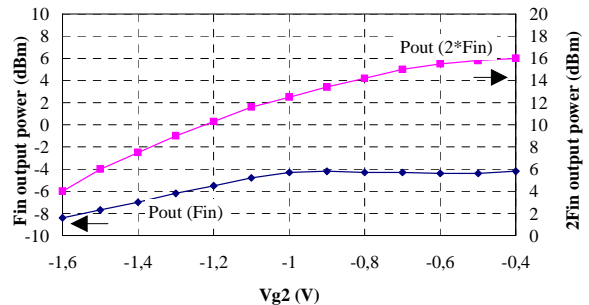

## Chip Assembly and Mechanical Data

Vd=3.5V Vg1=-0.9V Vg2=-0.4V.

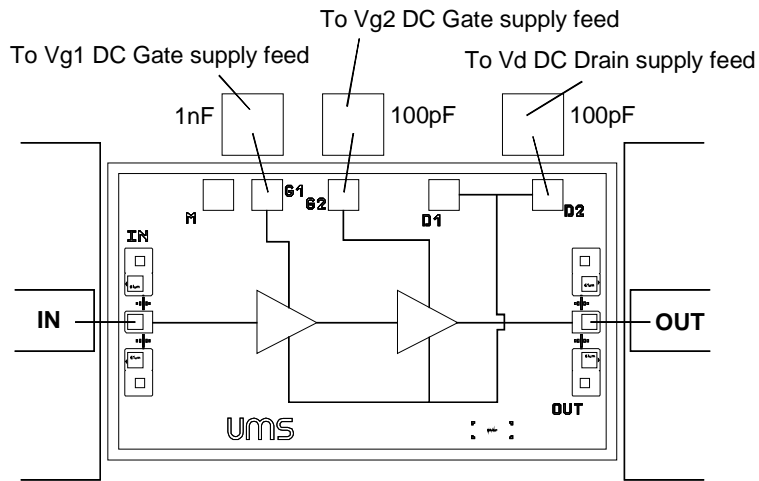

Note : Supply feed should be capacitively bypassed. 25µm diameter gold wire is to be preferred.

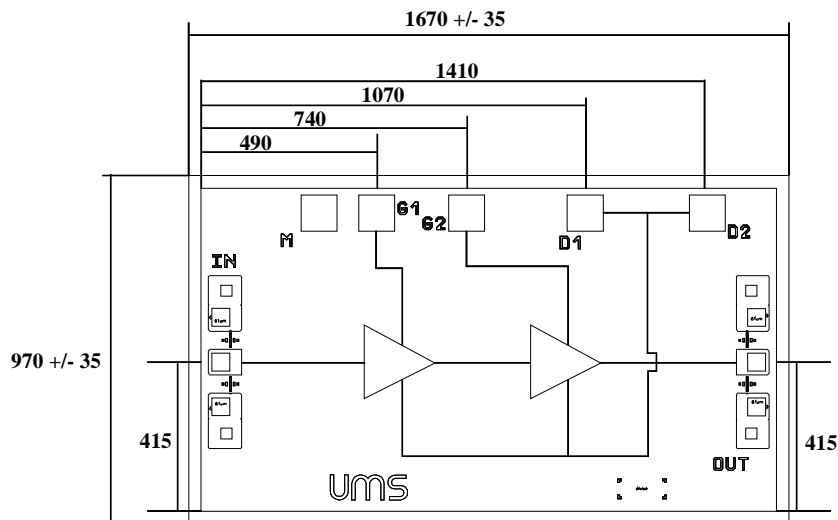

### Bonding pad positions

(Chip thickness: 100µm. All dimensions are in micrometers)

## Ordering Information

Chip form : CHX2090-99F/00

Information furnished is believed to be accurate and reliable. However **United Monolithic Semiconductors S.A.S.** assumes no responsibility for the consequences of use of such information nor for any infringement of patents or other rights of third parties which may result from its use. No license is granted by implication or otherwise under any patent or patent rights of **United Monolithic Semiconductors S.A.S.**. Specifications mentioned in this publication are subject to change without notice. This publication supersedes and replaces all information previously supplied. **United Monolithic Semiconductors S.A.S.** products are not authorised for use as critical components in life support devices or systems without express written approval from **United Monolithic Semiconductors S.A.S.**