

## 8-12GHz High Power Amplifier

### GaAs Monolithic Microwave IC

#### Description

The CHA6005-99F is a high power amplifier monolithic circuit, which integrates two stages and produces 32.5dBm output power associated to a high power added efficiency of 38%.

It is designed for a wide range of applications, from military to commercial communication systems.

The circuit is manufactured with a pHEMT process, 0.25µm gate length, via holes through the substrate, air bridges and electron beam gate lithography.

It is available in chip form.

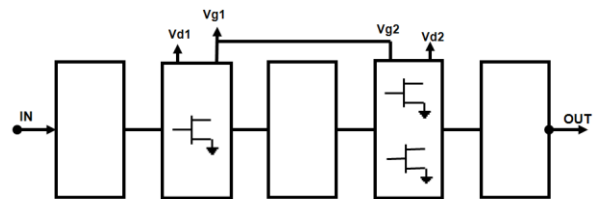

#### Main Features

- High power : 32.5dBm
- High PAE : 38%
- Frequency band : 8-12GHz
- Linear gain : 22dB
- DC bias: Vd=8Volt@Id=350mA
- Chip size 3x1.5x0.1mm

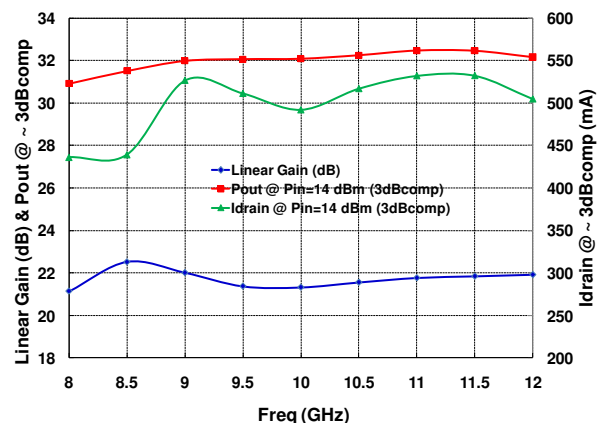

#### Main Electrical Characteristics

Tamb.= +25 °C

Symbol	Parameter	Min	Typ	Max	Unit
Freq	Frequency range	8		12	GHz
G	Linear Gain		22		dB
P1dB	Output Power @ 3dB comp.		31.5		dBm
PAE	Power Added Efficiency @ 3dB comp.		38		%

## Electrical Characteristics

Tamb.= +25°C, Vd = +8V

Symbol	Parameter	Min	Typ	Max	Unit
Freq	Operating frequency	8		12	GHz
G	Small signal gain		22		dB
dBS11	Input Return Loss		13		dB
dBS22	Output Return Loss		10		dB
P1dB	Output power @ 1dBcomp		31.5		dBm
P3dB	Output power @ 3dBcomp		32.5		dBm
PAE	Power Added Efficiency @ 3dBcomp		39		%
Id_3dBc	Supply drain current @ 3dBcomp		500		mA
Vd1, 2	Drain supply voltage		8		V
Id	Supply quiescent current		350		mA
Vg	Gate supply voltage		-1		V

These values are representative of on-wafer measurements that are made without bonding wires at the RF ports.

A bonding wire of typically 0.25 to 0.3nH will improve the matching at the accesses.

**Absolute Maximum Ratings** <sup>(1)</sup>

Tamb.= +25 °C

Symbol	Parameter	Values	Unit
Vd	Drain bias voltage	9.0	V
Id	Drain bias current	550	mA
Vg	Gate bias voltage	-0.6	V
Pin	Maximum peak input power overdrive <sup>(2)</sup>	+20	dBm
Tj	Junction temperature	175	°C
Ta	Operating temperature range	-40 to +85	°C
Tstg	Storage temperature range	-55 to +150	°C

<sup>(1)</sup> Operation of this device above anyone of these parameters may cause permanent damage.<sup>(2)</sup> Duration < 1s.**Typical Bias Conditions**

Tamb.= +25 °C

Symbol	Pad N°	Parameter	Values	Unit
V1	V1	Drain supply voltage	8	V
V2	V2	Gaye supply voltage	-1	V

## Typical on-wafer Sij parameters

Tamb.= +25°C, Vd = +8V, Id = 350mA

Freq (GHz)	S11 (dB)	PhS11 (°)	S12 (dB)	PhS12 (°)	S21 (dB)	PhS21 (°)	S22 (dB)	PhS22 (°)
1.0	-0.13	-24.56	-41.65	94.28	-41.00	5.33	-0.14	-31.59
1.5	-0.41	-36.99	-73.73	-169.07	-33.87	124.41	-0.25	-46.43
2.0	-0.91	-49.02	-69.95	74.68	-23.74	83.31	-0.36	-60.62
2.5	-1.58	-59.45	-63.20	3.88	-18.60	78.66	-0.45	-76.49
3.0	-2.38	-68.02	-56.66	157.15	-10.90	48.69	-0.33	-92.84
3.5	-2.84	-74.73	-63.04	94.69	-6.27	4.33	-0.30	-108.37
4.0	-3.31	-82.38	-57.85	-114.80	-3.73	-33.50	-0.46	-125.86
4.5	-3.93	-90.68	-60.34	158.64	-1.35	-66.01	-0.48	-144.00
5.0	-4.31	-97.82	-60.03	24.56	1.15	-94.43	-1.12	-163.74
5.5	-4.83	-106.35	-50.57	-80.01	4.11	-123.24	-1.84	175.57
6.0	-5.46	-116.08	-70.50	131.94	7.63	-154.66	-2.81	149.75
6.5	-6.62	-124.18	-55.54	-157.24	11.36	170.68	-4.14	117.44
7.0	-8.19	-132.30	-53.46	-7.29	15.47	129.40	-6.12	71.13
7.5	-9.90	-137.14	-55.00	-29.83	19.90	79.16	-7.72	6.74
8.0	-11.75	-139.76	-57.16	-149.65	22.91	14.32	-8.43	-68.64
8.5	-14.25	-147.90	-51.44	49.02	23.09	-50.26	-10.58	-110.20
9.0	-22.50	-149.89	-61.08	68.48	22.44	-104.62	-12.35	-122.40
9.5	-19.68	-36.57	-61.46	37.28	22.18	-154.83	-11.34	-131.10
10.0	-11.97	-46.88	-49.78	-37.51	22.25	154.10	-10.95	-144.80
10.5	-9.48	-66.85	-54.09	43.84	22.31	99.85	-11.30	-158.95
11.0	-9.03	-76.06	-45.08	-123.49	22.21	43.81	-12.08	-174.53
11.5	-8.28	-75.50	-45.12	-167.53	22.20	-18.84	-14.05	168.12
12.0	-7.24	-77.36	-46.53	178.36	21.59	-93.01	-19.54	110.78
12.5	-6.28	-73.12	-50.56	143.28	17.68	-177.82	-16.12	-41.18
13.0	-4.14	-77.38	-45.11	-73.10	10.97	108.88	-11.80	-75.70
13.5	-2.77	-86.29	-40.75	-41.28	3.20	49.97	-10.40	-90.23
14.0	-2.03	-97.24	-43.07	39.37	-4.83	-0.77	-8.93	-101.41
14.5	-1.55	-108.80	-46.25	-168.74	-12.75	-42.90	-7.39	-116.10
15.0	-1.57	-118.06	-61.73	-65.61	-20.85	-80.03	-6.32	-123.79
15.5	-1.81	-127.31	-40.65	56.06	-28.30	-106.29	-5.11	-131.17
16.0	-1.92	-138.32	-51.69	-38.56	-36.54	-126.10	-4.24	-145.42
16.5	-2.40	-143.30	-37.13	17.09	-40.98	170.77	-5.04	-150.20
17.0	-1.78	-155.35	-53.00	-31.01	-52.02	96.09	-3.40	-156.88
17.5	-2.71	-171.55	-30.56	-18.51	-34.16	104.30	-2.95	-165.99
18.0	-4.54	169.63	-37.57	-134.74	-41.04	-142.48	-3.18	-173.70

**Typical on Test Fixture Measurements**

Tamb.= +25 °C,  
 Vd = 8V, Id (Quiescent) = 350mA, Drain Pulse width = 25µs, Duty cycle = 10%

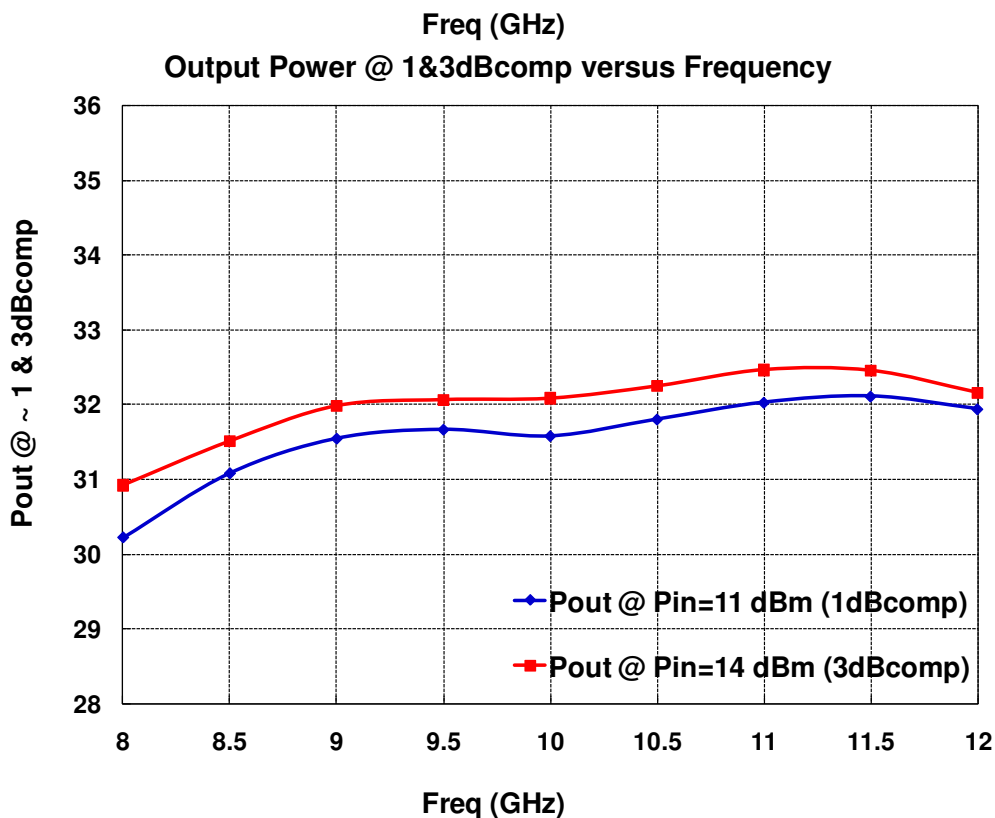
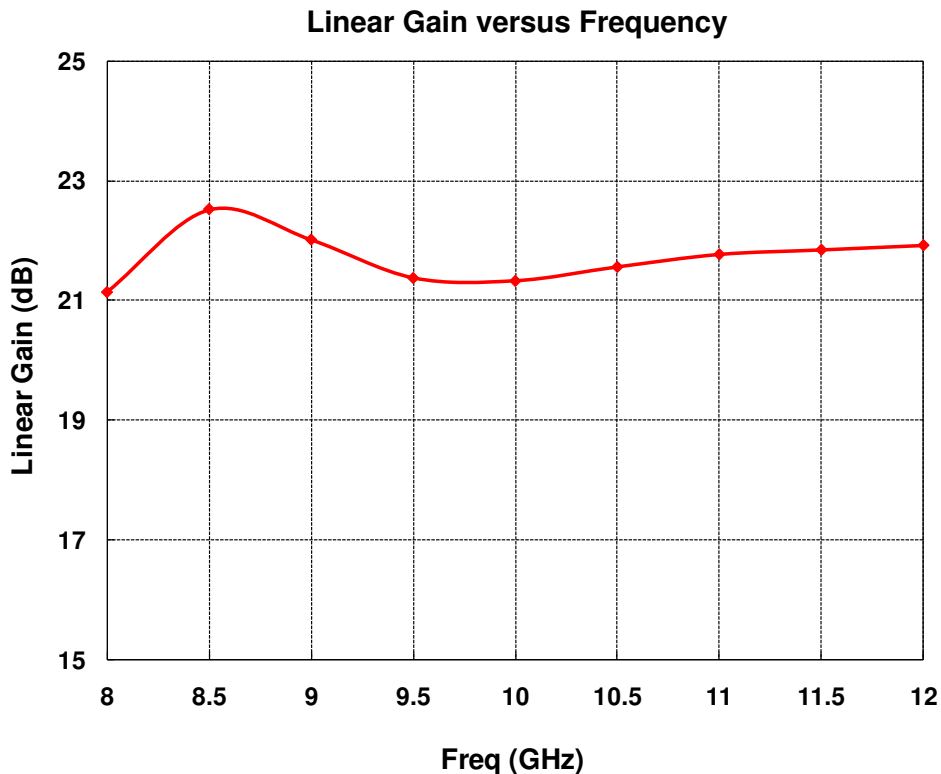

Typical Test Fixture Measurements

Tamb.= +25°C,

Vd = 8V, Id (Quiescent) = 350mA, Drain Pulse width = 25µs, Duty cycle = 10%

Power added efficiency @ 1 & 3dBcomp versus Frequency

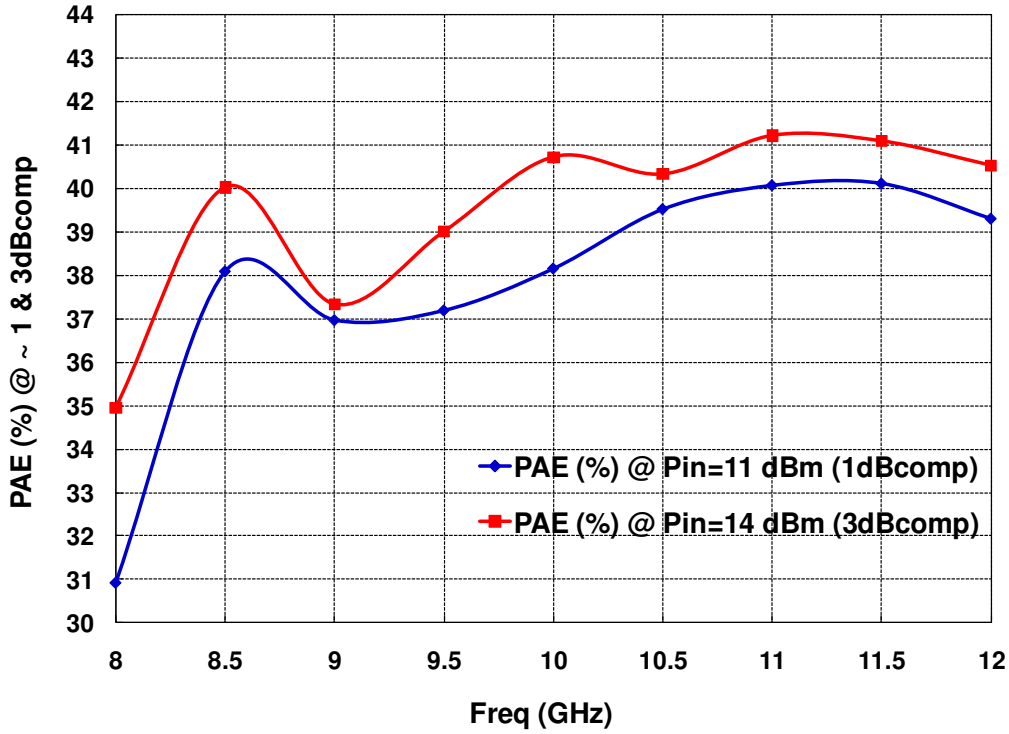

Drain current @ 1 & 3dBcomp versus Frequency

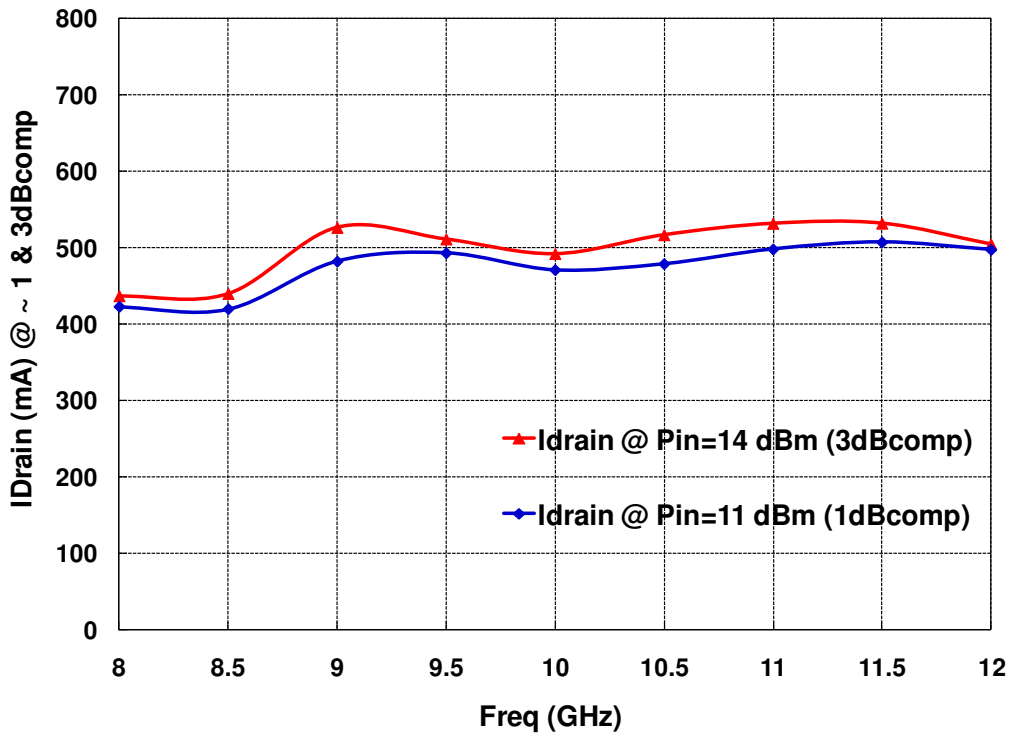

## Mechanical data

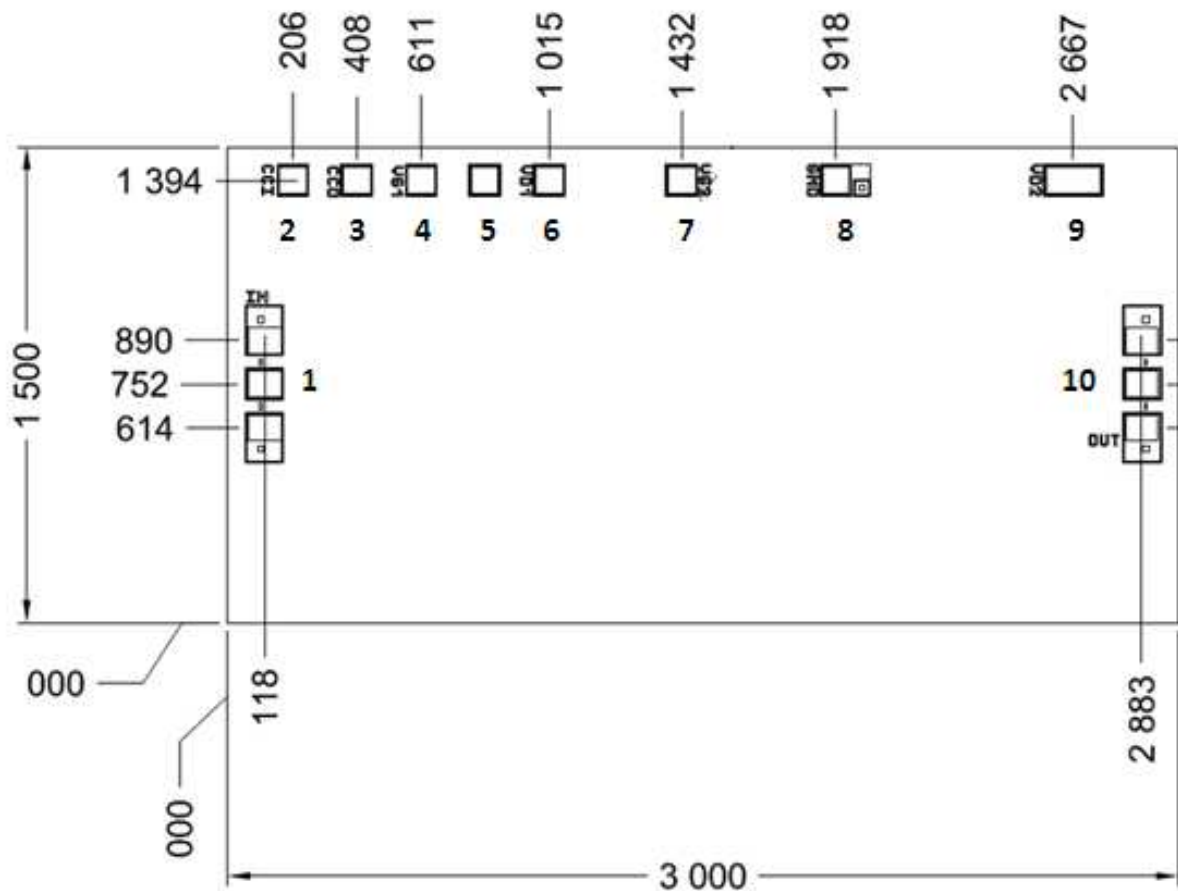

Chip thickness:  $70\mu\text{m} \pm 10\mu\text{m}$ .  
 Chip size:  $3000 \times 1500 \pm 35\mu\text{m}$   
 All dimensions are in micrometers

RF pads (1, 10) =  $122 \times 100\mu\text{m}^2$   
 DC pads (4, 6, 7, 8, 9) =  $100 \times 100\mu\text{m}^2$

Pin number	Pin name	Description
1	IN	Input RF
2, 3, 5, 8	-	Not Connected
4	VG1	Vg1
6	VD1	Vd1
7	VG2	Not Connected
8	GND	Not Connected
9	VD2	Vd2
10	OUT	Output RF

## Recommended assembly plan

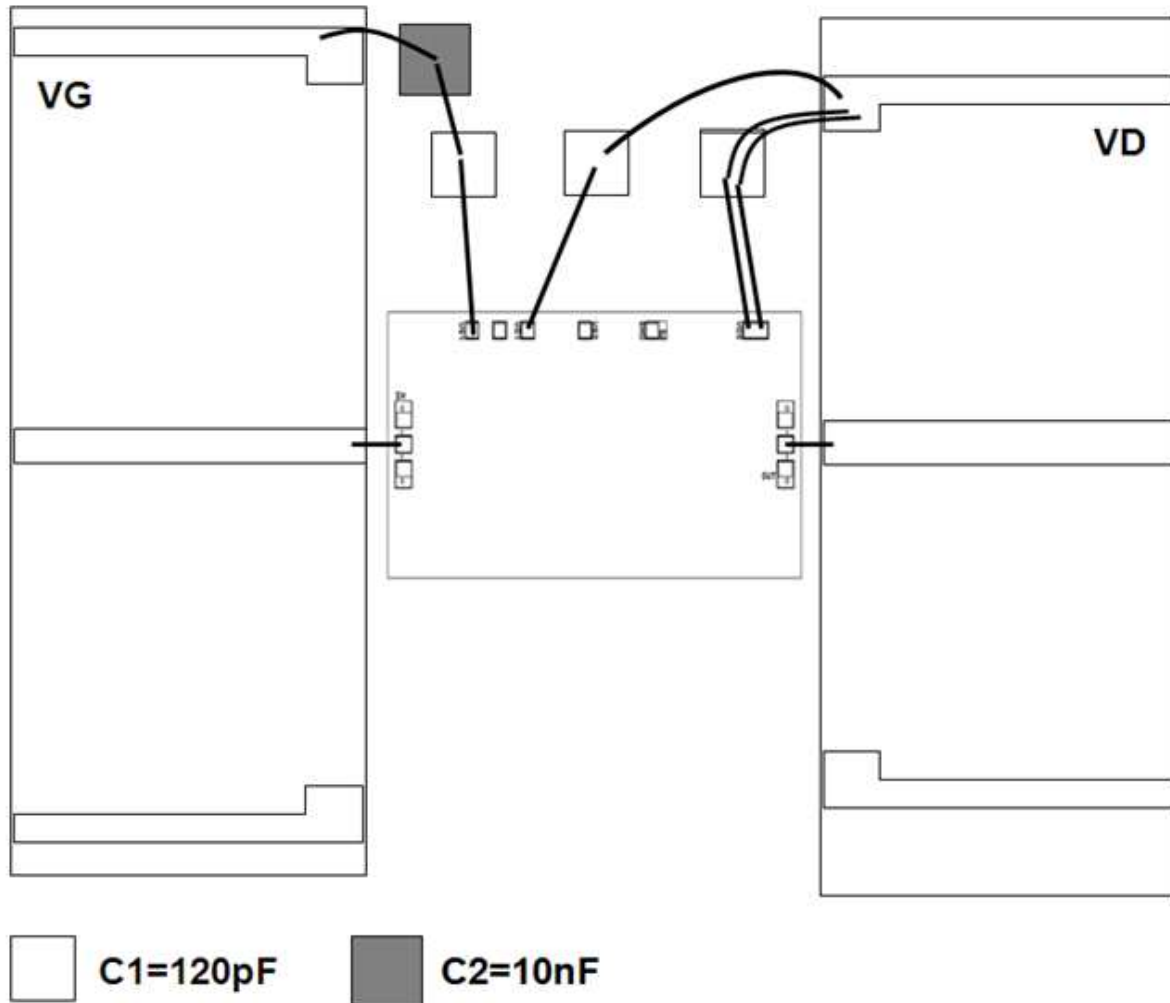

25µm wedge bonding is preferred

Note: Equivalent RF Wire Bonding: 0.25nH (typical length of 200µm for a 25µm diameter wire).

## Recommended circuit bonding table

Port	Connection	External capacitor
IN	Inductance (L <sub>bonding</sub> ) = 0.3nH 400µm length with a wire diameter of 25 µm	
OUT	Inductance (L <sub>bonding</sub> ) = 0.3nH 400µm length with a wire diameter of 25 µm	
VG	Inductance ≤ 1nH	C1 ~ 120pF, C2 ~ 10nF
VD	Inductance ≤ 1nH	C1 ~ 120pF



## Recommended ESD management

Refer to the application note AN0020 available at <http://www.ums-gaas.com> for ESD sensitivity and handling recommendations for the UMS products.

## Recommended environmental management

UMS products are compliant with the regulation in particular with the directives RoHS N°2011/65 and REACH N°1907/2006. More environmental data are available in the application note AN0019 also available at <http://www.ums-gaas.com>.

## Ordering Information

Chip form:

CHA6005-99F/00

Information furnished is believed to be accurate and reliable. However **United Monolithic Semiconductors S.A.S.** assumes no responsibility for the consequences of use of such information nor for any infringement of patents or other rights of third parties which may result from its use. No license is granted by implication or otherwise under any patent or patent rights of **United Monolithic Semiconductors S.A.S.** Specifications mentioned in this publication are subject to change without notice. This publication supersedes and replaces all information previously supplied. **United Monolithic Semiconductors S.A.S.** products are not authorised for use as critical components in life support devices or systems without express written approval from **United Monolithic Semiconductors S.A.S.**