

6-18GHz Amplifier

GaAs Monolithic Microwave IC

Description

The CHA3511 is composed of a Single Pole Single Through (SPST) switch followed by a double stage travelling wave amplifier. It is designed for defence, naval, or avionic applications. The backside of the chip is both RF and DC grounded. This helps to simplify the assembly process.

The circuit is manufactured with a Power pHEMT process, 0.25µm gate length, via holes through the substrate, air bridges and electron beam gate lithography.

It is available in chip form.

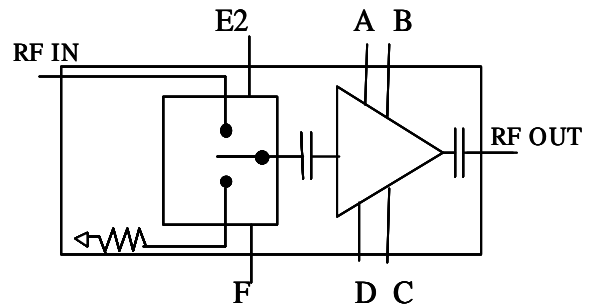

Typical on wafer Measurements
Gain versus switch states

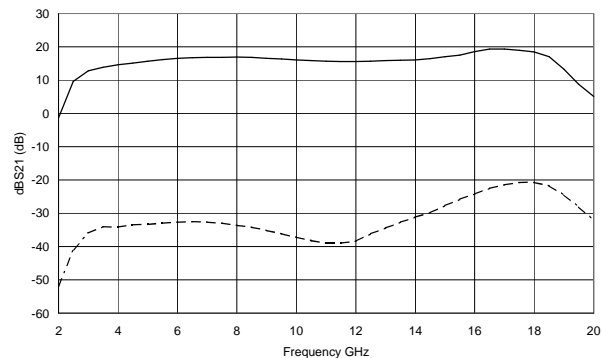

Main Features

- Wide Band: 6-18GHz
- 16dB gain
- 39dB isolation
- 22 dBm saturated output power
- DC power consumption, 190mA @ 4.5V
- Chip size: 3.55 x 2.30 x 0.1mm

Main Characteristics

Tamb. = 25°C

Symbol	Parameter	Min	Typ	Max	Unit
Fop	Operating frequency range	6		18	GHz
G	Small signal gain @ Switch on	15	16		dB
ISO	Delta Gain (1)	35	39		dB
Psat	Saturated Output power @Switch on	20	22		dBm

ESD Protection: Electrostatic discharge sensitive device. Observe handling precautions!

Electrical Characteristics on wafer

Tamb = +25°C

Vd (Pads D & B)= 4.5V, Vg (Pads A & C) tuned for Id= 190mA

Configuration Gain: E2=-5V; F=0V

Configuration isolation: E2=0V; F=-5V

Symbol	Parameter	Min	Typ	Max	Unit
Fop	Operating frequency range (1)	6		18	GHz
G	Small signal gain @ Config Gain		16		dB
ISO	Delta Gain between config Gain & config. Isolation	35	39		dB
P1dB	Output power at 1dB compression @ Config. Gain	18	20		dBm
Psat	Saturated Output power @ config. gain	20	22		dBm
NF	Noise figure @ Config. Gain				
	6-12 GHz		6	8	dB
	12-18 GHz		8	10	dB
VSWRin	Input VSWR @Config gain		2.3:1		
VSWRout	Output VSWR @Config. gain		2.0:1		
Vd	Drain bias DC voltage (Pads D,B)		4.5		V
Id	Bias current @ small signal		190	250	mA
Vc	Control voltage for Attenuator bits		-5/0		V

Absolute Maximum Ratings

Tamb. = 25°C (1)

Symbol	Parameter	Values	Unit
Vd	Maximum Drain bias voltage (Pads B,D)	+5	V
Id	Drain bias current with Vd=4.5V	300	mA
Vg	Gate bias voltage (Pads A, C)	-2 to +0.4	V
Vc	Fet switch gate voltage (2) SPST switch control voltage	-7 to +0.6	V
Pin	Maximum input power overdrive (3)	+20	dBm
Tch	Maximum channel temperature	+175	°C
Ta	Operating temperature range	-40 to +70	°C
Tstg	Storage temperature range	-55 to +125	°C

(1)Operation of this device above anyone of these parameters may cause permanent damage.

(2)The switch is ON in the following condition : Pad F=0V & Pad E2=-5V; the switch is OFF when pad F=-5V & PAD E2=0V

(2) Duration < 1s.

Circuit Biasing Conditions

Drain Voltage on B and D pads=4.5V

Gate voltage adjusted on A and C pads for a drain current =190mA

SPST Control		Configuration selected
E2	F	
-5V	0V	1: Gain
0V	-5V	2: Isolation

Typical chip on wafer Sij parameters for reference state

Tamb 25°C, Bias conditions: Vd(Pads B&D)=4.5V, Vg(Pads A & C) tuned for Id=190mA
 Configuration Gain: Pad E2=-5V / pad F=0V

Freq (GHz)	S11(dB)	PhS11(°)	S12(dB)	PhS12(°)	S21(dB)	PhS21(°)	S22(dB)	PhS22(°)
4.0	-9.5	154.9	-66.3	146.8	15.2	-67.3	-10.7	174.1
5.0	-12.0	129.9	-69.6	123.3	16.3	-129.1	-13.3	157.1
6.0	-14.3	107.7	-62.6	21.1	17.1	173.2	-15.0	140.2
7.0	-15.7	81.9	-59.2	-14.4	17.4	118.0	-16.9	122.9
8.0	-16.0	48.4	-56.1	-85.3	17.4	64.6	-17.8	103.3
9.0	-14.4	5.8	-54.0	-109.4	16.9	12.9	-18.3	69.8
10.0	-12.2	-34.4	-52.6	-157.0	16.4	-35.8	-18.6	29.4
11.0	-10.5	-68.9	-51.6	163.8	15.8	-81.7	-18.1	-18.3
12.0	-9.2	-99.1	-49.8	150.9	15.8	-125.7	-17.3	-70.0
13.0	-8.7	-126.1	-49.8	126.6	16.1	-170.8	-16.3	-125.6
14.0	-9.2	-154.5	-43.5	103.0	16.5	139.9	-17.2	163.7
15.0	-11.0	-175.5	-43.8	37.7	17.1	91.8	-19.4	78.6
16.0	-14.0	170.8	-45.2	-31.4	18.7	39.0	-17.0	-14.5
17.0	-15.9	-172.9	-45.7	-156.6	20.3	-30.3	-17.4	-87.5
18.0	-14.1	170.8	-40.8	110.8	19.3	-110.4	-14.6	-78.7
20.0	-10.5	102.1	-44.2	-9.5	6.6	94.2	-9.7	159.7

Typical on wafer Measurements @ 25°C

Bias conditions: Vd(Pads B&D)=4.5V, Vg(Pads A & C) tuned for Id=190mA
 Configuration Isolation: Pad E2=0V / pad F=-5V

Freq (GHz)	S11(dB)	PhS11(°)	S12(dB)	PhS12(°)	S21(dB)	PhS21(°)	S22(dB)	PhS22(°)
4.0	-1.2	149.2	-71.2	128.5	-33.8	176.0	-10.7	174.1
5.0	-1.3	142.1	-72.9	-158.1	-32.0	118.9	-13.2	156.8
6.0	-1.4	134.8	-75.1	-69.3	-31.7	64.8	-15.0	139.7
7.0	-1.5	127.3	-77.2	68.3	-31.8	17.7	-16.9	122.8
8.0	-1.6	119.7	-66.2	-152.4	-33.2	-30.2	-17.8	103.0
9.0	-1.7	112.0	-70.9	-152.7	-36.2	-83.2	-18.6	69.1
10.0	-1.8	104.0	-65.9	153.0	-36.6	-135.5	-18.9	30.0
11.0	-1.9	95.9	-57.7	163.6	-37.9	159.1	-18.8	-18.0
12.0	-2.0	87.6	-54.0	164.6	-38.5	97.6	-18.0	-67.5
13.0	-2.0	78.5	-50.2	132.6	-36.6	40.5	-17.5	-119.7
14.0	-2.1	69.3	-45.3	85.4	-33.8	-22.5	-18.1	-178.3
15.0	-2.2	59.6	-48.2	39.2	-30.4	-79.1	-19.7	101.3
16.0	-2.3	49.7	-49.3	9.4	-26.3	-136.8	-17.9	7.2
17.0	-2.3	39.4	-53.6	9.2	-23.0	158.2	-16.0	-65.9
18.0	-2.4	29.2	-50.9	10.9	-20.3	76.0	-14.2	-85.3
19.0	-2.5	19.0	-52.7	-40.9	-24.1	-17.5	-8.4	-143.6
20.0	-2.5	8.8	-58.2	-10.3	-34.6	-86.3	-9.6	159.3

Typical on wafer Measurements @ 25°C

Bias conditions: $V_d(\text{Pads B\&D})=4.5\text{V}$, $V_g(\text{Pads A \& C})$ tuned for $I_d=190\text{mA}$

**Configuration Gain (Pad E2=-5V/ Pad F=0V)
Gain/ input & output Return Loss**

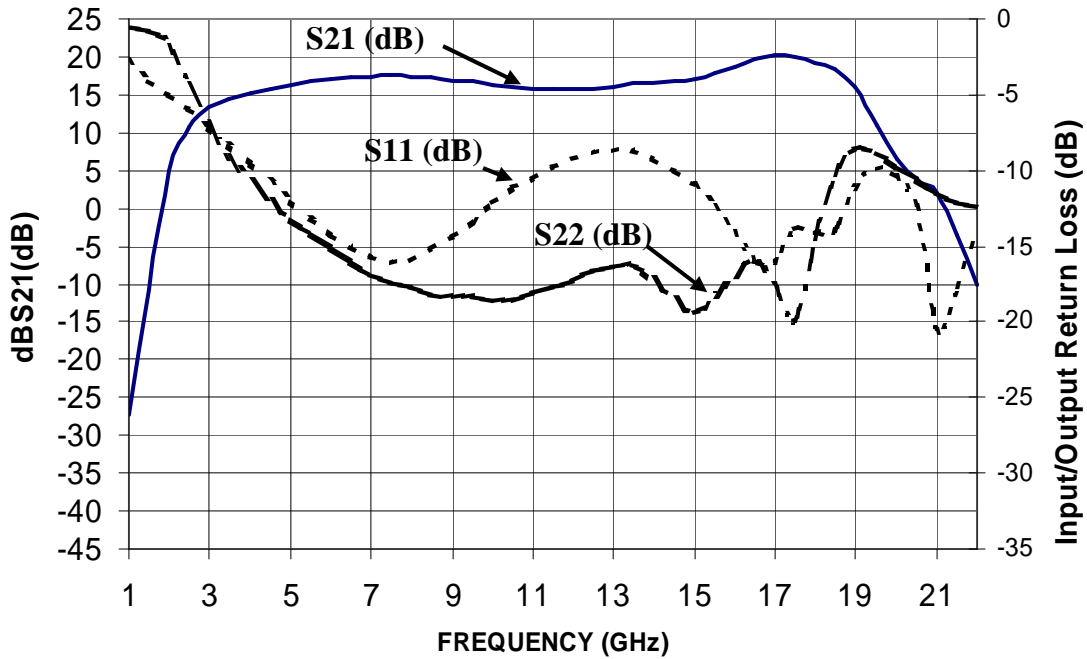

**Configuration Isolation (Pad E2=0V/ Pad F=-5V)
Isolation/ input & output Return Loss**

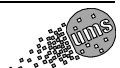
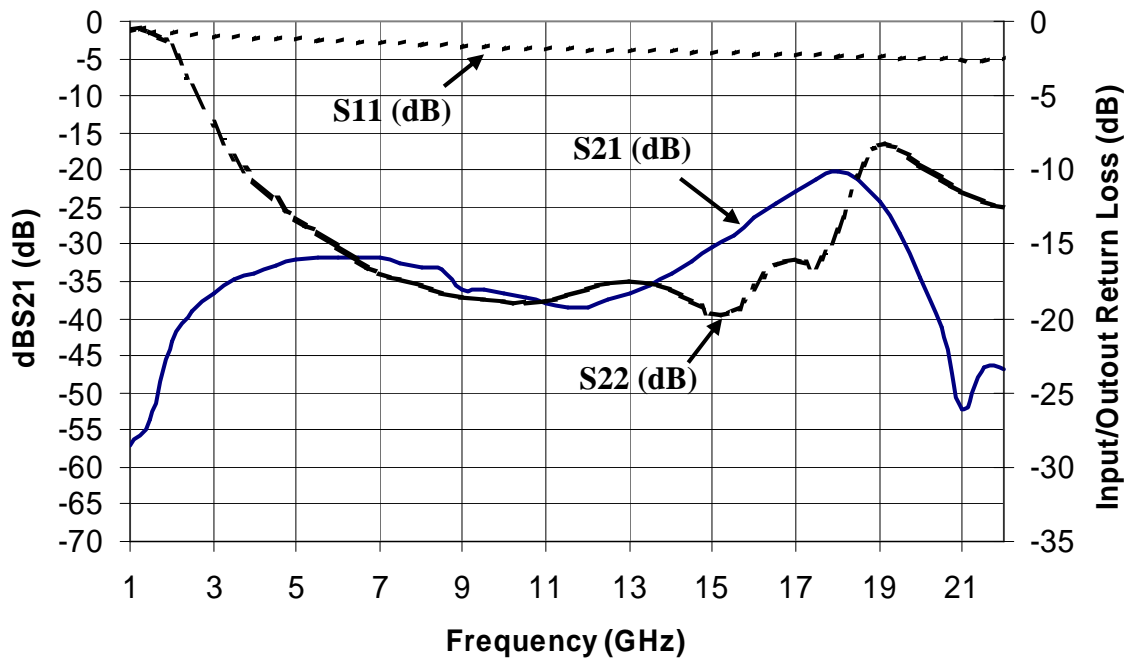

Typical test fixture Measurements

Bias conditions: V_d (Pads B & D)=4.5V, V_g (Pads A & C) tuned for $I_d = 190mA$
 Configuration Gain: Pad=E2=-5V/Pad F=0V

S Parameters: test fixture measurements Measurements versus temperature

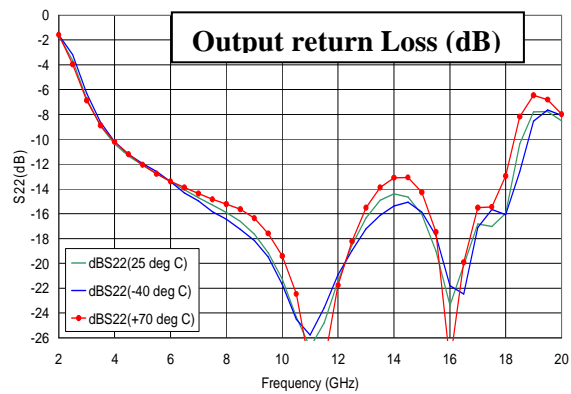
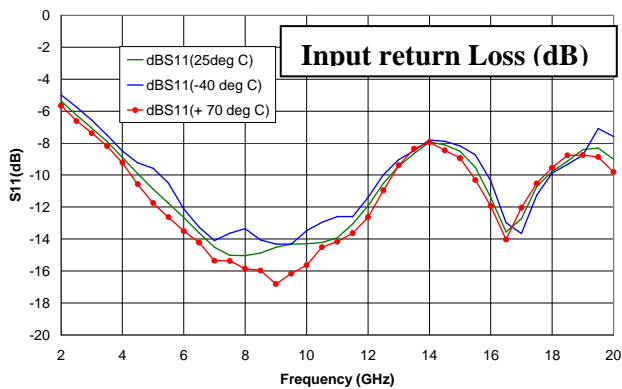
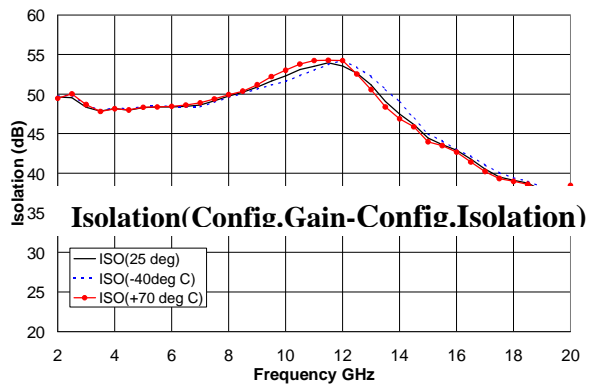
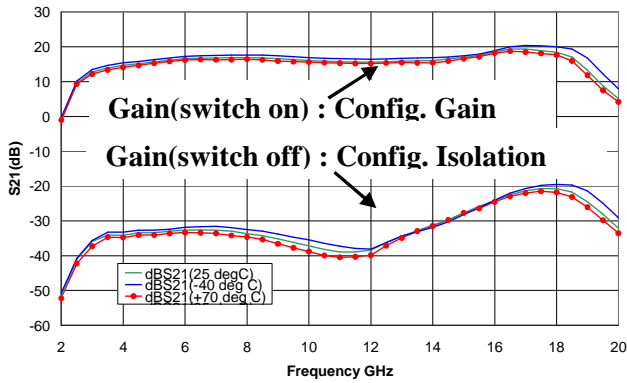

$T_{amb} = +25^{\circ}C$

Noise Figure: test fixture measurements

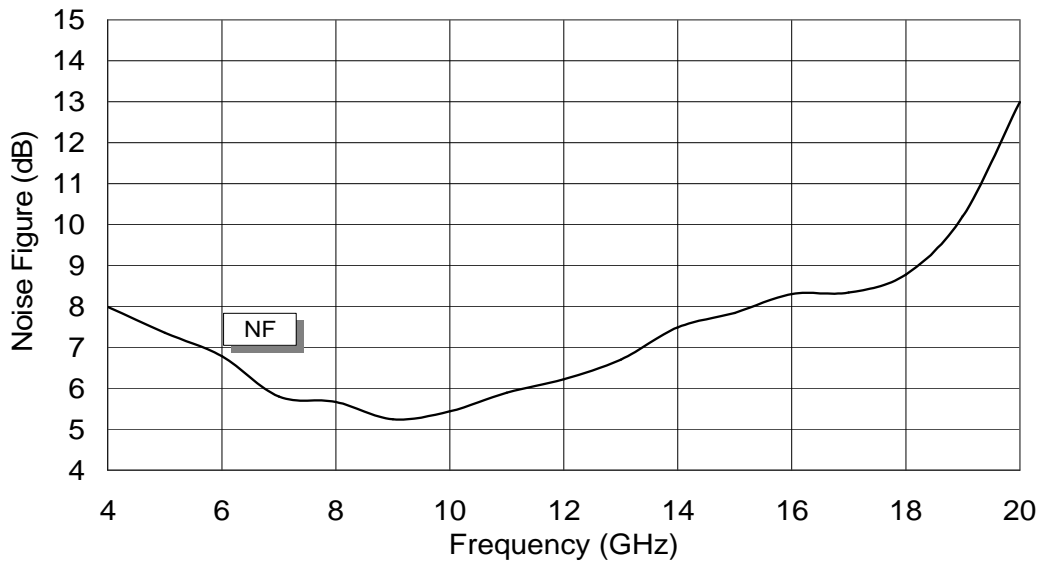

**Linear Gain & Output Power for 1 dB compression
Versus frequency
Test fixture measurement**

Tamb=+25°C
(configuration Gain)

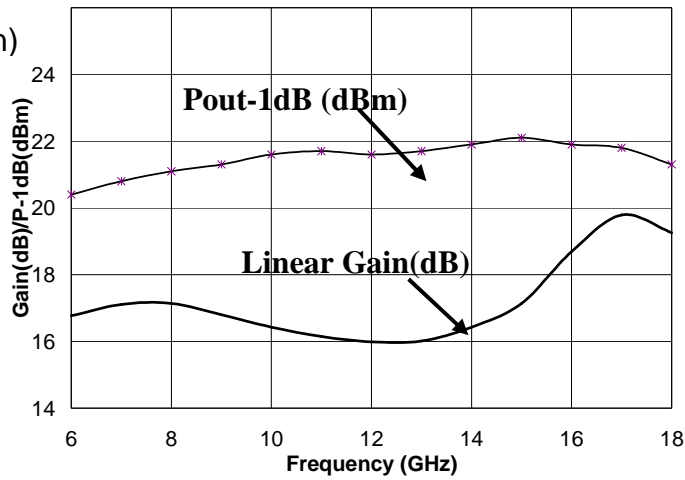

**Gain and Output power
Versus input power & Frequency
Test fixture measurement**

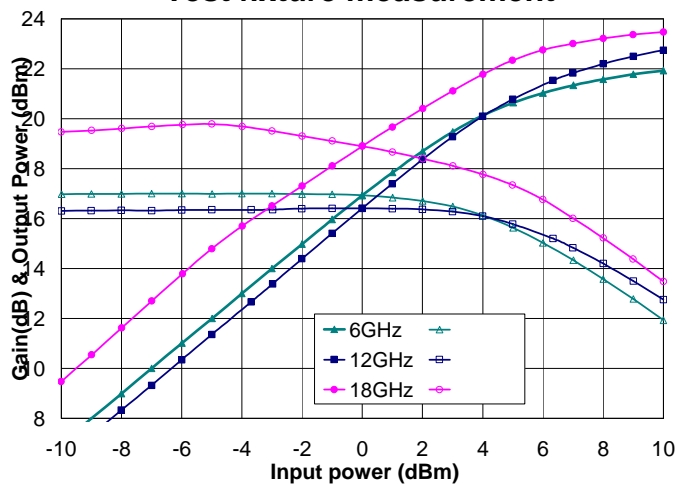

**Consumption versus Input power & frequency
Test fixture measurement**

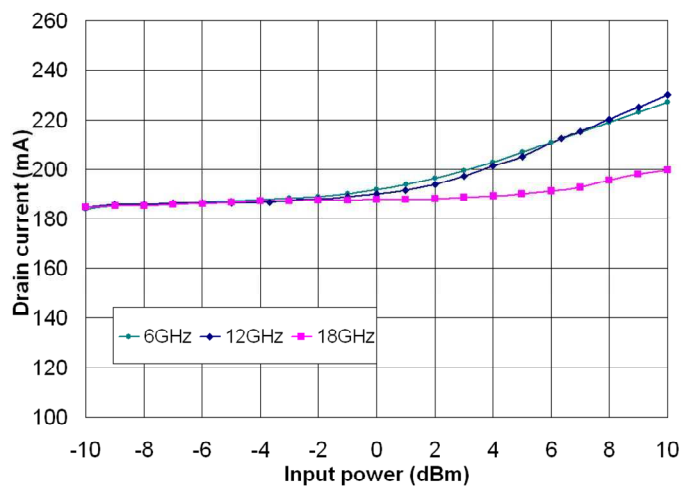

Chip Assembly and Mechanical Data

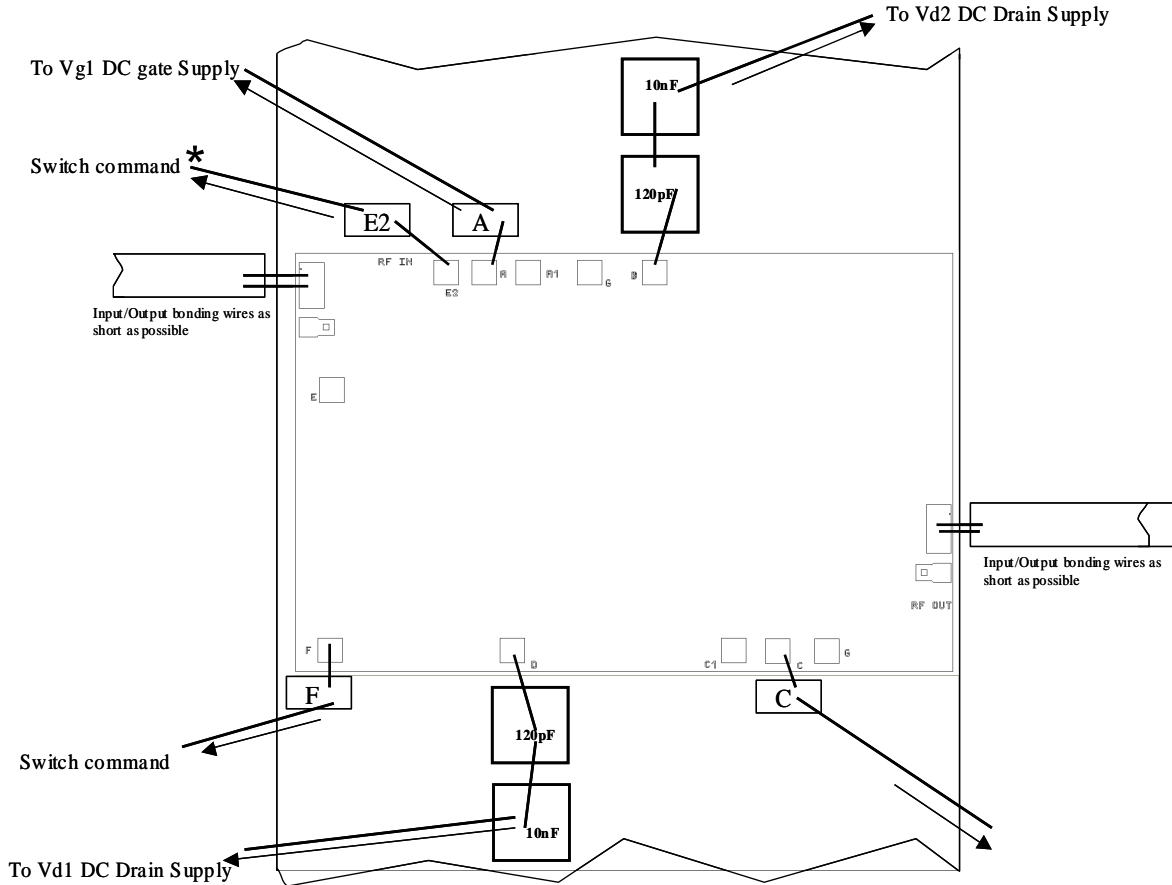

* The Pad E can be used in place of the Pad E2

Note : Supply feed should be capacitively bypassed. 25µm diameter gold wire is to be preferred.

Recommended circuit bonding table

Label	Type	Decoupling	Comment
B	Vd	120pF / 10nF	Drain Supply
D	Vd	120pF / 10nF	Drain Supply
A	Vg	Not required	Gate Supply
C	Vg	Not required	Gate Supply
E2	Vc	Not required	Switch control
F	Vc	Not required	Switch control

Ordering Information

Chip form : CHA3511-99F/00

Electronica S.p.A has the intellectual property of this MMIC and gives to **United Monolithic Semiconductors S.A.S.** non-exclusive license to sell it.

Information furnished is believed to be accurate and reliable. However **United Monolithic Semiconductors S.A.S.** assumes no responsibility for the consequences of use of such information nor for any infringement of patents or other rights of third parties which may result from its use. No license is granted by implication or otherwise under any patent or patent rights of **United Monolithic Semiconductors S.A.S.**. Specifications mentioned in this publication are subject to change without notice. This publication supersedes and replaces all information previously supplied. **United Monolithic Semiconductors S.A.S.** products are not authorised for use as critical components in life support devices or systems without express written approval from **United Monolithic Semiconductors S.A.S.**