

5-44GHz Detector

GaAs Monolithic Microwave IC

Description

The CHE1270a is a detector that integrates a matched detection diode (V_{det}). A reference diode is also available to be used in differential mode (V_{ref}).

It is designed for a wide range of applications where an accurate transmitted power control is required, typically commercial communication systems.

The circuit is manufactured with a Schottky diode MMIC process, $1\mu\text{m}$ gate length, via holes through the substrate and air bridges.

It is available in chip form.

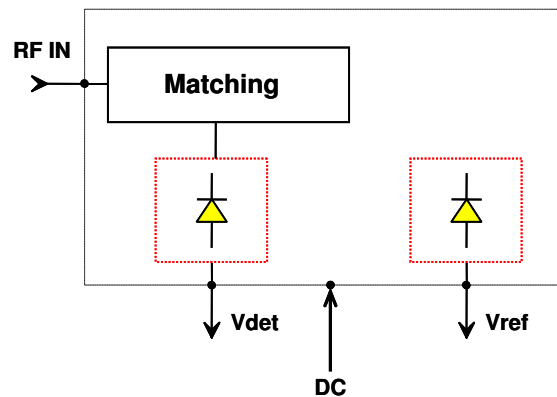

Main Features

- Wide frequency range 5-44GHz
- 30dB dynamic range
- ESD protected
- BCB layer protection
- Chip size: 1.34 x 0.82 x 0.1mm

Transmitted power detection (mV)

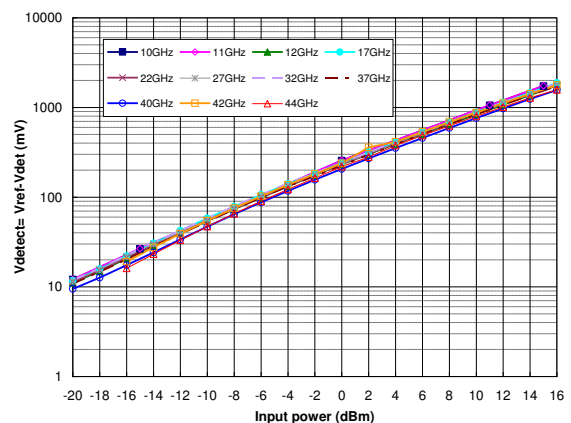

Main Characteristics

$T_{amb.} = +25^\circ\text{C}$

Symbol	Parameter	Min	Typ	Max	Unit
Freq	Frequency range	5		44	GHz
Dr	Dynamic range	30			dB
RL	Return Loss		-10		dB

Main CharacteristicsT_{amb.} = +25°C, V_{dc} = +4.5V

Symbol	Parameter	Min	Typ	Max	Unit
Freq	Frequency range	5		44	GHz
Dr	Dynamic range (for Input Power detection)	30			dB
IPd	Input Power detection	-15		15	dBm
Vdetect	Voltage detection V _{ref} – V _{det} from IPd_min to IPd_max	5		2200	mV
RL	Return Loss (5 – 10GHz)		-4	-3	dB
	Return Loss (10 – 12GHz)		-7	-5	dB
	Return Loss (12 – 14.5GHz)		-8	-6	dB
	Return Loss (14.5 – 42GHz)		-10	-8	dB
	Return Loss (42 – 44GHz)		-7	-5	dB
Vdc	Bias voltage		4.5		V
Idc	Bias current	50	70	90	μA

These values are representative of on-wafer measurements that are made without bonding wires at the RF ports but with 27kΩ resistor in parallel on pads V_{det} and V_{ref}.

Absolute Maximum Ratings ⁽¹⁾T_{amb.} = +25 °C

Symbol	Parameter	Values	Unit
V _{dc}	Drain bias voltage	6V	V
IP _{dmax}	Maximum Input Power detection	+18	dBm
T _a	Operating temperature range	-40 to +85	°C
T _{stg}	Storage temperature range	-55 to +150	°C

⁽¹⁾ Operation of this device above any one of these parameters may cause permanent damage.

Typical on wafer Measurements

Tamb.= +25°C, Vdc = +4.5V

Return Loss versus frequency

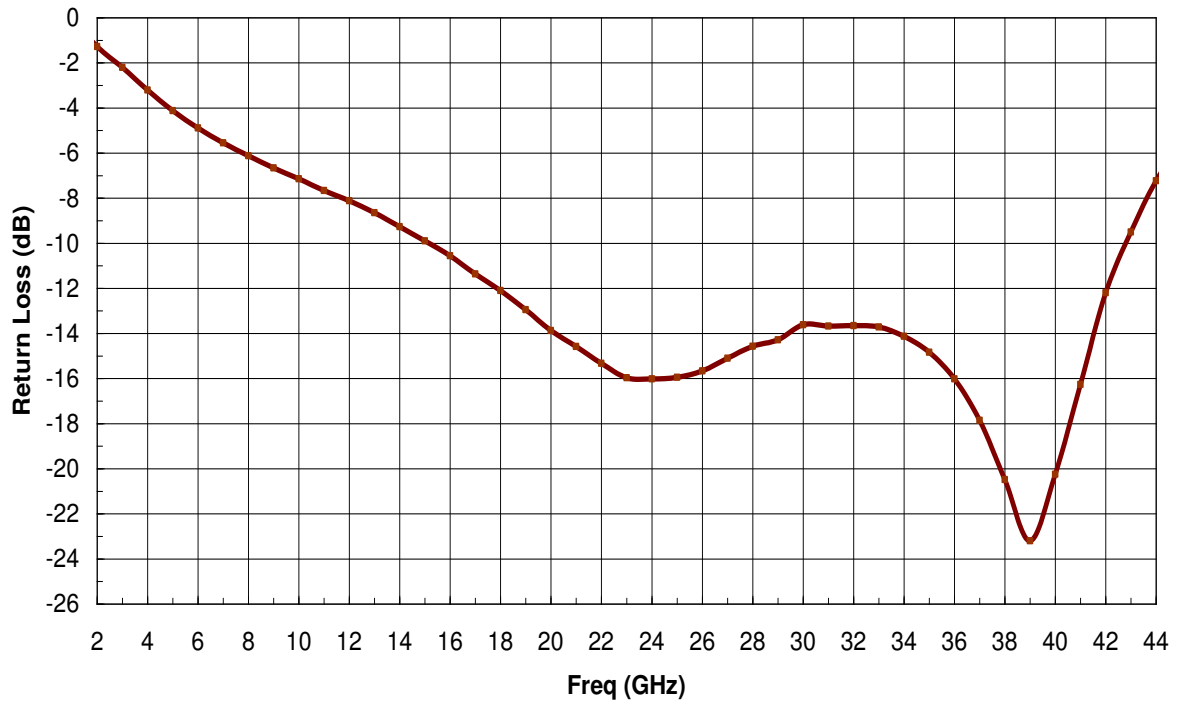

Transmitted power detection

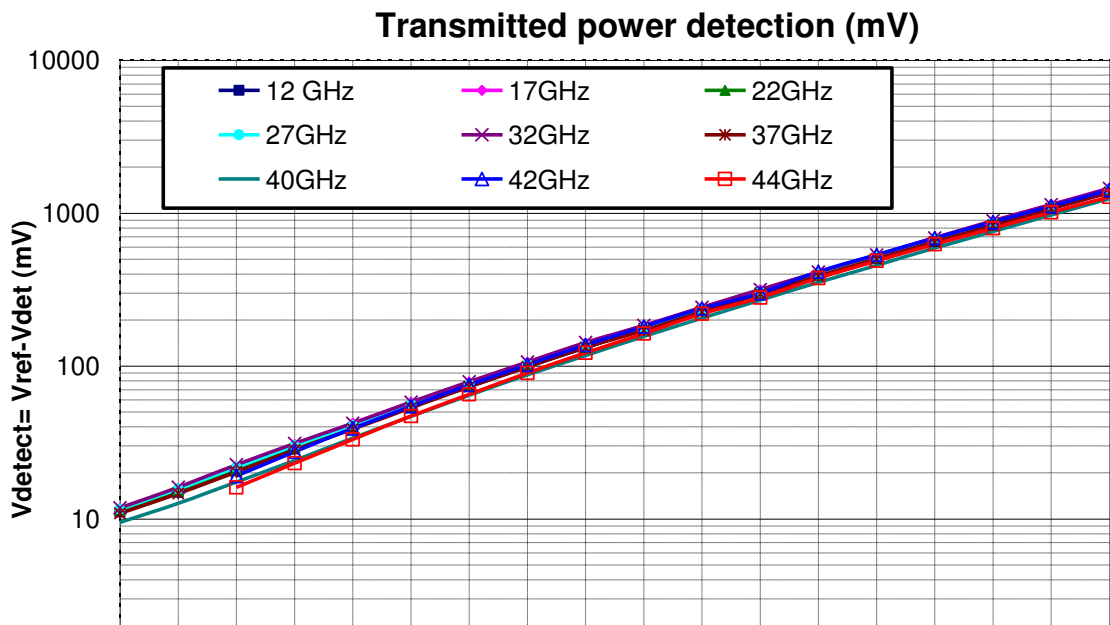

Typical on wafer Measurements

Tamb.= +25°C, Vdc = +4.5V

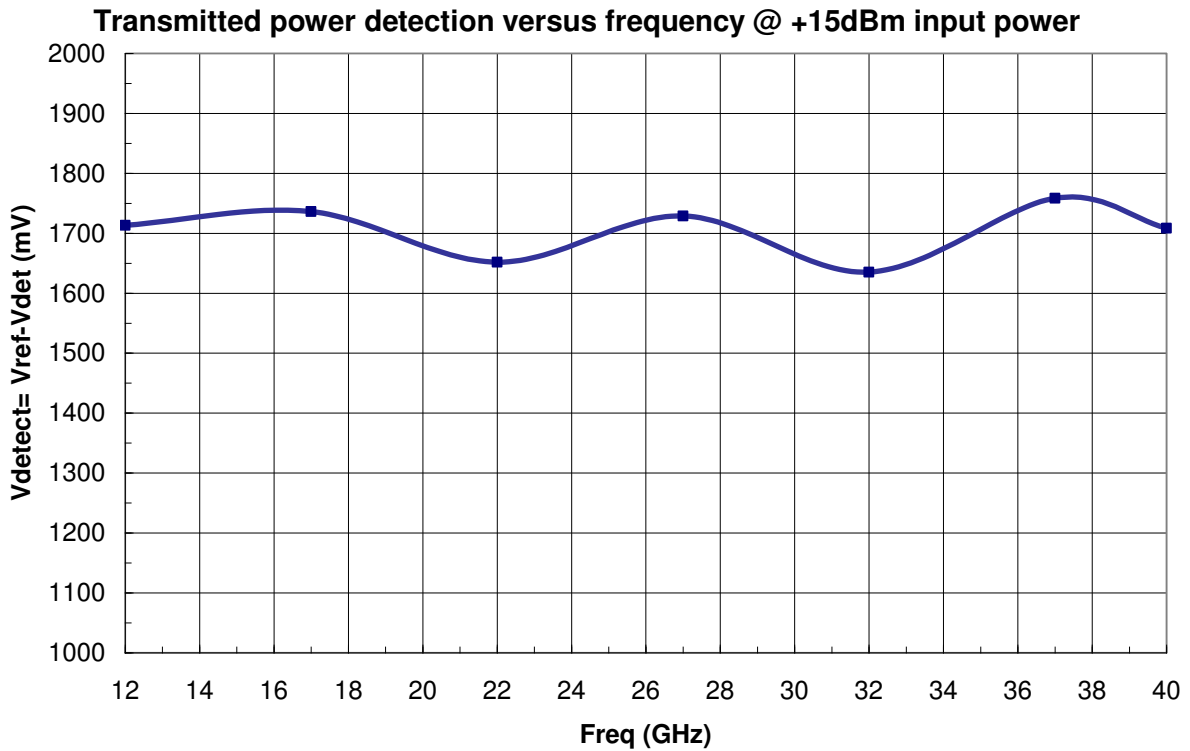
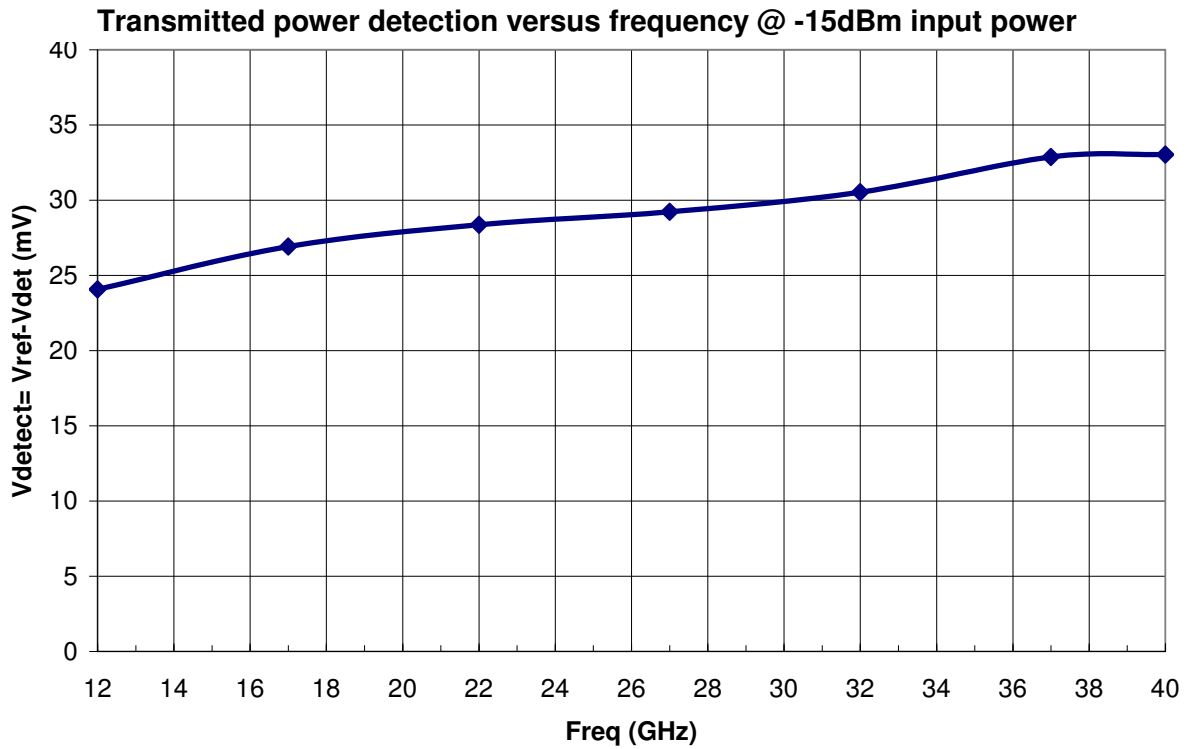

Mechanical data

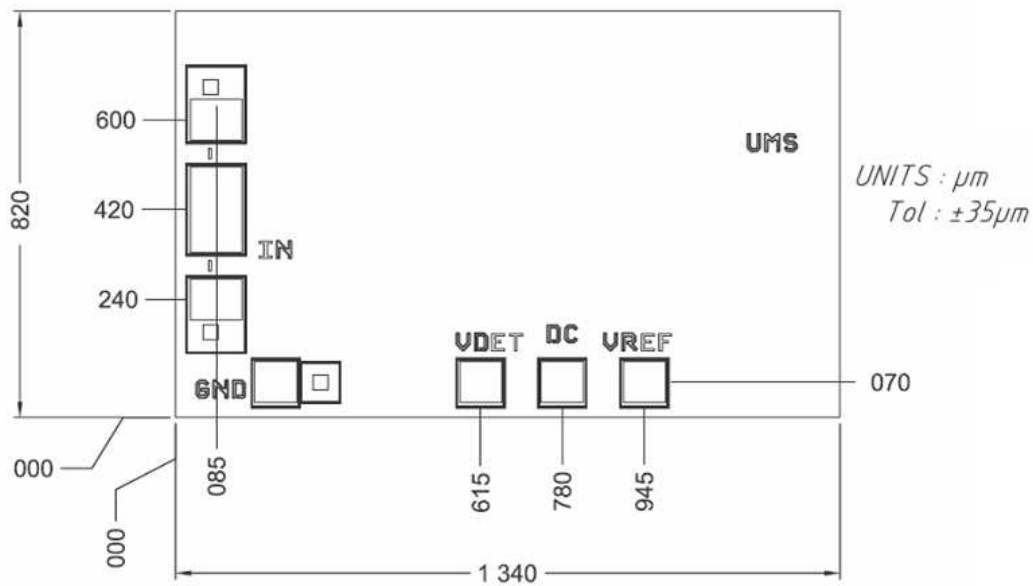

Chip thickness: 100μm
 Chip size: 1.34 x 0.82 x 0.1mm
 DC Pads Size: 100/100 μm
 All dimensions are in micrometers

Note: Supply feed might be capacitively bypassed. 25μm diameter gold wire is to be preferred.

Notes

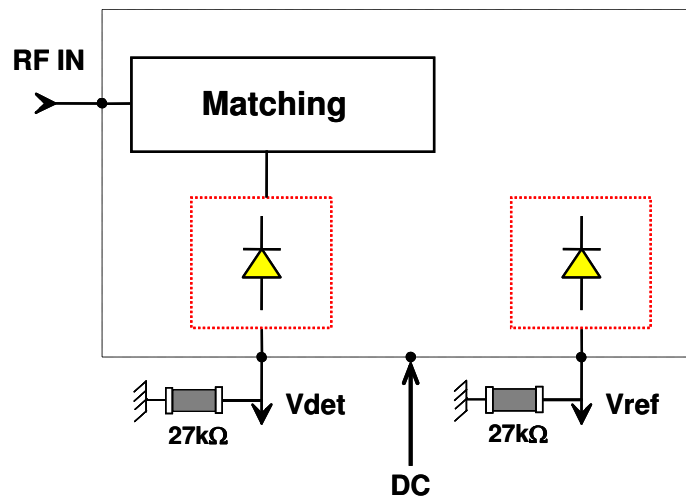

Recommended external resistors assembly

27kΩ resistors in parallel with Vdet and Vref pads are recommended to provide the best behaviour in the whole operating temperature range.

As the voltage detection is the difference between Vref and Vdet, the external resistor value should be identical on these two ports.

For information, a variation of 3% leads around 1mV variation of detected voltage.

Due to ESD protection circuits on RF input, an external capacitance might be requested to isolate the product from external voltage that could be present on the RF access. ESD protections are also implemented on Vdet and Vref accesses.

Due to the BCB coating on the chip, qualification domain implies the chip must be glued.

Recommended ESD management

Refer to the application note AN0020 available at <http://www.ums-gaas.com> for ESD sensitivity and handling recommendations for the UMS products.

Recommended environmental management

UMS products are compliant with the regulation in particular with the directives RoHS N°2011/65 and REACH N°1907/2006. More environmental data are available in the application note AN0019 also available at <http://www.ums-gaas.com>.

Ordering Information

Chip form:

CHE1270a98F/00

Information furnished is believed to be accurate and reliable. However **United Monolithic Semiconductors S.A.S.** assumes no responsibility for the consequences of use of such information nor for any infringement of patents or other rights of third parties which may result from its use. No license is granted by implication or otherwise under any patent or patent rights of **United Monolithic Semiconductors S.A.S.**. Specifications mentioned in this publication are subject to change without notice. This publication supersedes and replaces all information previously supplied. **United Monolithic Semiconductors S.A.S.** products are not authorised for use as critical components in life support devices or systems without express written approval from **United Monolithic Semiconductors S.A.S.**