



SANYO Semiconductors

DATA SHEET

LV76213A2C

Monolithic Linear IC
 For PAL/NTSC Color Television Sets
 VIF/SIF/Y/C/Deflection /CbCr IN
 Implemented in a Single Chip

Overview

The LV76213A2C is VIF/SIF/Y/C/D/Deflection /CbCr IN Implemented in a single chip for PAL/NTSC color television sets.

Functions

- VIF / SIF / Y / C / Deflection / CbCr IN / Implemented in a Single Chip with CPU
- I²C Bus Control

Specifications

BIP Chip Maximum Ratings at Ta=25°C

Parameter	Symbol	Conditions	Ratings	Unit
Allowable power dissipation	Pd max	Ta ≤65°C (*1)	1.3	W
Operating temperature	Topr		-10 to +65	°C
Storage temperature	Tstg		-55 to +150	°C
Maximum supply voltage	V62 max		6.0	V
	V4 max		6.0	V
Maximum supply current	I9 max		15	mA
	I20 max		20	mA
	I49 max		26.5	mA

(*1) Provided with a glass epoxy board (230×150×1.6 mm)

■ Any and all SANYO Semiconductor Co.,Ltd. products described or contained herein are, with regard to "standard application", intended for the use as general electronics equipment (home appliances, AV equipment, communication device, office equipment, industrial equipment etc.). The products mentioned herein shall not be intended for use for any "special application" (medical equipment whose purpose is to sustain life, aerospace instrument, nuclear control device, burning appliances, transportation machine, traffic signal system, safety equipment etc.) that shall require extremely high level of reliability and can directly threaten human lives in case of failure or malfunction of the product or may cause harm to human bodies, nor shall they grant any guarantee thereof. If you should intend to use our products for applications outside the standard applications of our customer who is considering such use and/or outside the scope of our intended standard applications, please consult with us prior to the intended use. If there is no consultation or inquiry before the intended use, our customer shall be solely responsible for the use.

■ Specifications of any and all SANYO Semiconductor Co.,Ltd. products described or contained herein stipulate the performance, characteristics, and functions of the described products in the independent state, and are not guarantees of the performance, characteristics, and functions of the described products as mounted in the customer's products or equipment. To verify symptoms and states that cannot be evaluated in an independent device, the customer should always evaluate and test devices mounted in the customer's products or equipment.

LV76213A2C

BIP Operating Conditions at Ta=25°C

Parameter	Symbol	Conditions	Ratings	Unit
Recommended supply voltage	V ₆₂		5.0	V
	V ₄		5.0	V
Recommended supply current	I ₉		11	mA
	I ₂₀		13	mA
	I ₄₉		22	mA
Operating supply voltage range	V ₆₂		4.7 to 5.3	V
	V ₄		4.7 to 5.3	V
Operating supply current range	I ₉		9 to 13	mA
	I ₂₀		11 to 15	mA
	I ₄₉		20.5 to 26.5	mA

(note) μ -Controller Chip : LC873264A , C : MASKROM=64Kbyte(Program_ROM:48Kbyte/character_ROM:16Kbyte)

Package Dimensions

unit : mm (typ)

3300

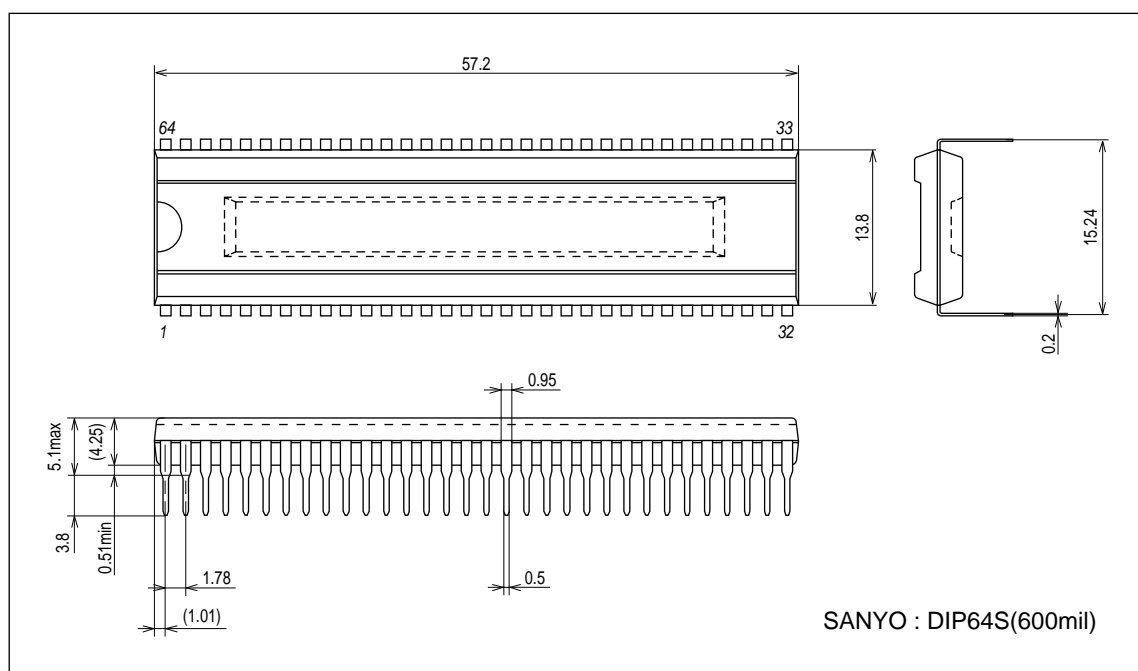

LV76213A2C

μ-Controller Chip Absolute maximum ratings at Ta=25°C, VSS=0V

Parameter	Symbol	Pins	Conditions	Limits				unit
				VDD[V]	min	typ	max	
Maximum Supply voltage	VDD max	CpuVDD			-0.3	~	+6.0	V
Input voltage	VI	XT1,RES#			-0.3	~	VDD+0.3	
Output voltage	VO1	XT2,FILT			-0.3	~	VDD+0.3	
	VO2	CpuVDD2			-0.3	~	3.3V+0.3	
Input/output voltage	VIO	Ports0,1			-0.3	~	VDD+0.3	
High level output current	Peak output current	IOPH	Ports04~07,1	•CMOS output •For each pin.	-10			mA
	Mean Output current	IOMH	Ports04~07,1	•CMOS output •For each pin.	-1			
	Total output current	ΣIOAH	Ports04~07,1	The total of all pins.	-25			
Low level output current	Peak output current	IOPL	Ports0,1	For each pin			20	
	Mean output current	IOML1	P02,P03,P06,P07 Ports1	For each pin			1	
		IOML2	P00,P01,P04,P05	For each pin			8	
	Total output Current	ΣIOAL1	P02,P03,P06,P07 Ports1	The total of all pins.				
ΣIOAL2		P00,P01,P04,P05	The total of all pins.				16	

μ-Conttoller Chip Recommended operating range at Ta=-10°C to +65°C, VSS=0V

Parameter	Symbol	Pins	Conditions	Limits				unit
				VDD[V]	min.	typ.	max.	
Operating supply voltage range	VDD	CpuVDD	0.229μs≤tCYC≤200μs		4.5		5.5	V
Hold voltage	VHD	CpuVDD	RAMs and the registers data are kept in HOLD mode.		2.0		5.5	
High level input Voltage	VIH1	Ports0,1, P00 port input /interrupt		4.5 to 5.5	0.3VDD +0.7		VDD	
	VIH2	Port00 Watch-dog timer		4.5 to 5.5	0.9VDD		VDD	
	VIH3	RES#		4.5 to 5.5	0.75VDD		VDD	
Low level input Voltage	UIL1	Ports0,1, P00 port input /interrupt		4.5 to 5.5	VSS		0.1VDD +0.4	
	UIL2	Port00 Watch-dog timer		4.5 to 5.5	VSS		0.15VDD -0.4	
	UIL3	RES#		4.5 to 5.5	VSS		0.25VDD	
Operation cycle time (*3)	tCYC1		All functions operating	4.5 to 5.5		0.231		μs
	tCYC2		OSD and Data slicer are not operating	4.5 to 5.5	0.231		200	
Oscillation frequency range	FmVCO1		Built-in VCO1 Oscillation System clock	4.5 to 5.5		13.0		MHz
	FmVCO2 (*4)		Built-in VCO2 oscillation OSD clock	OCKSEL=0	4.5 to 5.5	12.5		
						OCKSEL=1	16.6	
	FmRC		Built-in RC oscillation	4.5 to 5.5	0.3	1.0	2.0	
FsX'tal	XT1(P07), XT2(P06)		At the 32.768KHz crystal Oscillating See the figure1	4.5 to 5.5		32.768		KHz
Oscillation stabilizing time	tmsVCO		•after the HOLD mode •Power-On	4.5 to 5.5		300		mS

(*3) Relational expression between Tcyc and oscillation frequency;
1/1 frequency dividing: 3/FmVCO1, 1/2 frequency dividing: 6/FVCO1.

(*4) OCKSEL is the selectable register for OSD clock frequency. (See the LC873300 users manual for details.)

LV76213A2C

BIP Chip Electrical Characteristics at Ta=25°C, ICC=I9=11mA ICC=I20=13mA ICC=I49=22mA VCC=V62= V4=5.0V

Parameter	Symbol	Conditions	min	typ	max	Unit
[Circuit voltage, current]						
Horizontal supply voltage	V20	I20=13mA	4.7	5.0	5.3	V
Logic supply voltage	V9	I9=11mA	3.0	3.3	3.6	V
RGB supply voltage	V49	I49=22mA	7.8	8.15	8.5	V
IF supply current	I62	V62=5.0V	67	78	89	mA
Video supply current	I4	V4=5.0V	79	99	119	mA
[VIF block]						
Maximum RFAGC voltage	VRFH	CW=80 dBμ, DAC=0	4.3	4.7	5	Vdc
Minimum RFAGC voltage	VRFL	CW=80 dBμ, DAC=63	0	0.3	0.7	Vdc
RF AGC Delay Pt (@DAC=0)	RFAGC0	DAC=0	90	-	-	dBμ
RF AGC Delay Pt (@DAC=63)	RFAGC63	DAC=63	-	-	80	dBμ
Input sensitivity	Vi	Output-3db	-	-	46	dBμ
Sync signal tip level	VOtip	CW=80 dBμ	1.1	1.4	1.7	Vdc
Video output amplitude	VO	80dBu,AM=78%,fm=15kHz	1.90	2.00	2.10	Vp_p
Video S/N	S/N	CW=80 dBμ	40	45	-	dB
C-S beat level	IC-S	V4.43MHz/V1.07MHz	35	-	-	dB
Differential gain	DG	80 dBμ, 87.5% Video MOD	-	10	15	%
Differential phase	DP	80 dBμ, 87.5% Video MOD	-	5.0	10.0	deg
APC pull-in range(U)	fPU		2.0	-	-	MHz
APC pull-in range(L)	fPL		2.0	-	-	MHz
NTSC Trap1(4.5MHz)	NTR1		-	-	-27	dB
BG Trap1(5.5MHz)	BTR1		-	-	-27	dB
I Trap1(6.0MHz)	ITR1		-	-	-27	dB
DK Trap1(6.5MHz)	DTR1		-	-	-27	dB
[SIF block]						
FM detection output voltage	SOADJ	FM=±50kHz	450	630	850	mVrms
FM limiting sensitivity	SLS	Output -3dB	-	-	60	dBμ
FM detection output f characteristics	SF	fm=100kHz	-0.5	6.0	10.0	dB
FM detection output distortion	STHD	FM=±50kHz	-	-	3.0	%
SIF S/N	SSN	DIN Audio	45.0	-	-	dB
[AUDIO block]						
Volume gain (Stereo mode)	AVGT	1kHz	-3.0	0.0	+3.0	dB
Maximum output voltage (Stereo mode)	AVOT	1kHz THD=1%	0.8	1.0	1.2	Vrms
Frequency characteristic (Stereo mode)	AFREQT		-	20	30	kHz
Total harmonic distortion (Stereo mode)	ATHDT	DIN Audio	-	0.05	0.25	%
Output voltage noise (Stereo mode)	ANOT	DIN Audio	-	-75	-70	dBV
Cross talk (Stereo mode)	ACTT	DIN Audio	-	-80	-70	dB
Volume gain (Mono mode)	AVGM	1kHz	-3.0	0.0	+3.0	dB
Maximum output voltage (Stereo mode)	AVOM	1kHz THD=1%	0.8	1.0	1.2	Vrms
Frequency characteristic (Mono mode)	AFREQM		-	20	30	kHz
Total harmonic distortion (Mono mode)	ATHDM	DIN Audio	-	0.05	0.20	%
Output voltage noise (Mono mode)	ANOM	DIN Audio	-	-75	-70	dBV
Maximum output voltage (Surround mode)	AVOS	1kHz MODE-C, THD=1%	4	7	10	dB
Total harmonic distortion (Surround mode)	ATHDS	DIN Audio	-	0.2	0.5	%
Output voltage noise (Surround mode)	ANOS	DIN Audio	-	-750	-700	dBV
Bass band control range	AGEQB	100Hz	±9	±13	±17	dB
Treble band control range	AGEQT	10kHz	±9	±13	±17	dB
Mute	AMUTE	DIN Audio	-	-80	-70	dB
L/R Balance	ABT	1kHz	-1.0	0	1.0	dB

LV76213A2C

Parameter	Symbol	Conditions	min	typ	max	Unit
[Video block]						
Video overall gain (Contrast max)	CONT127		11.0	13.5	16.0	dB
Contrast adjustment Characteristics (Normal/max)	CONT64		-7.0	-4.5	-2.0	dB
Contrast adjustment characteristics (Min/max)	CONT0		-17.0	-13.5	-10.0	dB
Video frequency Characteristics 1 NTSC	BW1	1.8MHz/100kHz , Y Filter.sys = 00	-6.0	-3.0	0.0	dB
Video frequency characteristics 2 PAL	BW2	2.2MHz/100kHz , Y Filter.sys = 01	-6.0	-3.0	0.0	dB
Video frequency characteristics 3 WIDE	BW3	2.3MHz/100kHz , Y Filter.sys = 10	-6.0	-3.0	0.0	dB
Video frequency characteristics 4 APF	BW4	3.4MHz/100kHz , Y Filter.sys = 00,Y APF=1	-6.0	-3.0	0.0	dB
Chroma trap amount PAL	CtrapP	Y Filter.sys = 01		-26.0	-20.0	dB
Chroma trap amount NTSC	CtrapN	Y Filter.sys = 00		-26.0	-20.0	dB
DC restoration rate 1	ClampG1	DC.Rest=00	95.0	100.0	105.0	%
DC restoration rate 2	ClampG2	DC.Rest=01	101.0	106.0	111.0	%
DC restoration rate 3	ClampG3	DC.Rest=10	104.0	111.0	119.0	%
DC restoration rate 4	ClampG4	DC.Rest=11	115.0	125.0	133.0	%
Y-DL TIME1	TdY1	Y Filter.Sys=00 Y Delay Ajust=0100		680		ns
Y-DL TIME2	TdY2	Y Filter.Sys=01 Y Delay Ajust=0100		660		ns
Y-DL TIME3	TdY3	Y Filter.Sys=11,Delay Test=1 Y Delay Ajust=0100		800		ns
Y-DL TIME4	TdY4	Y Filter.Sys=10 Y Delay Ajust=0100		450		ns
Y-DL TIME Ajust1	TdYa1	Y Filter.Sys=00 Y Delay Ajust=0000		580		ns
Y-DL TIME Ajust2	TdYa2	Y Filter.Sys=00 Y Delay Ajust=0111		700		ns
Black stretch gain max	BKSTmax	Blk.Str.Gain=10 ,Blk.Str.Start=01	19.0	24.0	31.0	IRE
Black stretch gain mid	BKSTmid	Blk.Str.Gain=01 ,Blk.Str.Start=01	12.0	17.0	24.0	IRE
Black stretch gain min	BKSTmin	Blk.Str.Gain=00 ,Blk.Str.Start=01	5.0	10.0	16.0	IRE
Black stretch start point max (60IRE ΔV)	BKSTTHmax	Blk.Str.Gain=01 ,Blk.Str.Start=10	-4.0	0.0	6.0	IRE
Black stretch start point mid (50IRE ΔV)	BKSTTHmid	Blk.Str.Gain=01 ,Blk.Str.Start=01	-5.0	0.0	5.0	IRE
Black stretch start point min (40IRE ΔV)	BKSTTHmin	Blk.Str.Gain=01 ,Blk.Str.Start=00	-5.0	0.0	5.0	IRE
Sharpness variability range NTSC (trap 1 mid) (trap 1 max) (trap 1 min)	Sharp32T1	F=2.2MHz,Y Filter.Sys=00, Y Gamma Start=11,C_Kill.ON=1	2.0	5.0	8.0	dB
	Sharp63T1	F=2.2MHz,Y Filter.Sys=00, Y Gamma Start=11,C_Kill.ON=1	10.0	13.0	16.0	dB
	Sharp0T1	F=2.2MHz,Y Filter.Sys=00, Y Gamma Start=11,C_Kill.ON=1	-9.5	-6.5	-3.5	dB
Sharpness variability range PAL (trap 2 mid) (trap 2 max) (trap 2 min)	Sharp32T2	F=2.7MHz,Y Filter.Sys=01, Y Gamma Start=11,C_Kill.ON=1	2.0	5.0	8.0	dB
	Sharp63T2	F=2.7MHz,Y Filter.Sys=01, Y Gamma Start=11,C_Kill.ON=1	10.0	13.0	16.0	dB
	Sharp0T2	F=2.7MHz,Y Filter.Sys=01, Y Gamma Start=11,C_Kill.ON=1	-10.5	-7.5	-4.5	dB
Sharpness variability range 6MHz TRAP (trap 4 mid) (trap 4 max) (trap 4 min)	Sharp32T4	F=3.0MHz,Y Filter.Sys=10, Y Gamma Start=11,C_Kill.ON=1	2.0	5.0	8.0	dB
	Sharp63T4	F=3.0MHz,Y Filter.Sys=10, Y Gamma Start=11,C_Kill.ON=1	11.0	14.0	17.0	dB
	Sharp0T4	F=3.0MHz,Y Filter.Sys=10, Y Gamma Start=11,C_Kill.ON=1	-13.0	-8.0	-5.0	dB

LV76213A2C

Parameter	Symbol	Conditions	min	typ	max	Unit
White peak limiter effective point1	WPL1	APL=100% WPL=00	135	150	165	IRE
White peak limiter effective point2	WPL2	APL=100% WPL=01	105	120	135	IRE
White peak limiter effective point3	WPL3	APL=100% WPL=10	80	95	110	IRE
White peak limiter effective point4	WPL4	APL=100% WPL=11	60	75	90	IRE
Y gamma Start effective point 1	YGST1	Y Gamma Start=00, Y Gamma GAIN=01		55		IRE
Y gamma Start effective point 2	YGST2	Y Gamma Start=01, Y Gamma GAIN=01		65		IRE
Y gamma Start effective point 3	YGST3	Y Gamma Start=10, Y Gamma GAIN=01		68		IRE
Y gamma gain 1	YGGA1	Y Gamma Start=01, Y Gamma GAIN=00		220		IRE
Y gamma gain 2	YGGA2	Y Gamma Start=01, Y Gamma GAIN=01		250		IRE
Y gamma gain 3	YGGA3	Y Gamma Start=01, Y Gamma GAIN=10		260		IRE
Gray Mode Level	GRAY	GLAY MODE=1, Cross B/W=10	12.5	16.0	19.5	IRE
Horizontal/vertical blanking output level	RGBBLK		-	0.3	0.5	V
Pre-shoot adjust1	PreShoot1	Pre-shoot adj.=00	0.92	0.97	1.02	
Pre-shoot adjust2	PreShoot2	Pre-shoot adj.=11	1.08	1.13	1.18	
Over-shoot adjust	OverShoot	Over-shoot adj.=11	1.08	1.13	1.18	
[RGB output(cutoff drive)block]						
Brightness control (Normal)	BRT64		1.9	2.3	2.7	V
Brightness control (Normal-H)	BRT64H		3.5	3.9	4.3	V
Hi brightness (max)	BRT127		20.0	27.5	35.0	IRE
Low brightness (min)	BRT0		-35.0	-27.5	-20.0	IRE
Cutoff control (min)	Vbias0		1.7	2.3	2.9	V
(Bias control) (max)	Vbias255		2.7	3.3	3.9	V
Resolution	Vbiassns		-	3.5	-	mV/Bit
Sub-bias control Resolution	Vsbiassns		-	7	-	mV/Bit
RGB Drive adjustment Maximum output	RGBout127		1.9	2.3	2.7	V _{pp}
RGB Output attenuation	RGBout0		6	10	13	dB
[Ext.RGB input block]						
Ext.RGB input Fast SW threshold	ExFSTH		2.0	2.5	3.0	V
Ext.Red output level	Ext.RH		120	170	220	IRE
Ext.Green output level	Ext.GH		120	170	220	IRE
Ext.Blue output level	Ext.BH		120	170	220	IRE
Analog Ext.R output level gain match	Ext.R		0.8	1.0	1.2	ratio
Linearity	Ext.LR		40	50	60	%
Analog Ext.G output level gain match	Ext.G		0.8	1.0	1.2	ratio
Linearity	Ext.LG		40	50	60	%
Analog Ext.B output level gain match	Ext.B		0.8	1.0	1.2	ratio
Linearity	Ext.LB		45	50	60	%
[Video SW block]						
Video signal input 1DC voltage	V _{IN} 1DC	Video SW.=00	1.9	2.2	2.5	V
Video signal input 1AC voltage	V _{IN} 1AC	Video SW.=00		1		V _{p-p}
Video signal input 2DC voltage	V _{IN} 2DC	Video SW.=01	1.9	2.2	2.5	V
Video signal input 2AC voltage	V _{IN} 2AC	Video SW.=01		1		V _{p-p}
Video signal input 3DC voltage	V _{IN} 3DC	Video SW.=10	1.9	2.2	2.5	V
Video signal input 3AC voltage	V _{IN} 3AC	Video SW.=10		1		V _{p-p}
Video signal input 4DC voltage	V _{IN} 4DC	Video SW.=11	1.9	2.2	2.5	V
Video signal input 4AC voltage	V _{IN} 4AC	Video SW.=11		1		V _{p-p}
SVO pin DC voltage	SVODC	Video SW.=01,SVO SW=1 YCMIX=0	1.6	1.9	2.2	V
SVO pin AC voltage	SVOAC	Video SW.=01,SVO SW=1 YCMIX=0	1.7	2	2.3	V _{p-p}
SVO pin Ycmix AC Voltage	SVOYC	Video SW.=01,SVO SW=1 YCMIX=1	0.20	0.28	0.36	V _{p-p}

LV76213A2C

Parameter	Symbol	Conditions	min	typ	max	Unit
[Chroma block]: PAL/NTSC common						
B-Y/Y amplitude ratio	CLRBY		75	100	150	%
Color control characteristics 1	CLRMN	Color MAX/CEN	4	6	8	ratio
Color control characteristics 2	CLRMM	Color MAX/MIN	30	45	65	dB
Color control sensitivity	CLRSE		1	2	4	%/bit
fsc output level	FSC40	a reference value		350		mVp-p
Residual higher harmonic level B	E_CAR_B				300	mVp-p
Residual higher harmonic level R	E_CAR_R				300	mVp-p
Residual higher harmonic level G	E_CAR_G				300	mVp-p
[Chroma block]: PAL						
ACC amplitude characteristics 1	ACCM1_P	Input:+6dB/0dB 0dB=40IRE	0.7	1.0	1.2	ratio
ACC amplitude characteristics 2	ACCM2_P	Input:-20dB/0dB	0.7	1.0	1.1	ratio
Demodulation output ratio R-Y/B-Y:PAL	RB_P	R-Y/B-Y_GainBalance, R-Y/B-Y_Angle:Center	0.50	0.56	0.67	ratio
Demodulation output ratio G-Y/B-Y:PAL	GB_P	R-Y/B-Y_GainBalance, R-Y/B-Y_Angle:Center, R-Y=no-signal	-0.24	-0.19	-0.17	ratio
Demodulation output ratio G-Y/R-Y:PAL	GR_P	R-Y/B-Y_GainBalance, R-Y/B-Y_Angle:Center, B-Y=no-signal	-0.56	-0.51	-0.46	ratio
Demodulation angle R-Y/B-Y:PAL	ANGRB_P	R-Y/B-Y_GainBalance, R-Y/B-Y_Angle:Center	85	90	95	°C
Killer operating point 0 (PAL)	KILLP0	0dB=40IRE	-44		-31	dB
Killer operating point 3 (PAL)	KILLP3	0dB=40IRE	-46		-33	dB
Difference between two Killer operating points (PAL)	DKILLP	KILLP0-KILLP3	0.5		6.0	dB
APC pull-in range (+)	PULIN+_P		350			Hz
APC pull-in range (-)	PULIN-_P				-350	Hz
[Chroma block]:NTSC						
ACC amplitude characteristics 1	ACCM1_N	Input:+6dB/0dB 0dB=40IRE	0.7	1.0	1.2	ratio
ACC amplitude characteristics 2	ACCM2_N	Input:-20dB/0dB	0.7	1.0	1.1	ratio
Demodulation output ratio R-Y/B-Y: NTSC	RB_N	R-Y/B-Y_GainBalance, R-Y/B-Y_Angle:Center	0.80	0.90	1.00	ratio
Demodulation output ratio G-Y/B-Y: NTSC	GB_N	R-Y/B-Y_GainBalance, R-Y/B-Y_Angle:Center	0.22	0.27	0.38	ratio
Demodulation angle B-Y/R-Y: NTSC	ANGBR_N	R-Y/B-Y_GainBalance, R-Y/B-Y_Angle:Center	95	105	111	°C
Demodulation angle G-Y/B-Y: NTSC	ANGGB_N	R-Y/B-Y_GainBalance, R-Y/B-Y_Angle:Center	230	240	250	°C
Killer operating point 0 (NTSC)	KILLN0	0dB=40IRE	-44		-33	dB
Killer operating point 3 (NTSC)	KILLN3	0dB=40IRE	-46		-34	dB
Difference between two Killer operating points (NTSC)	DKILLN	KILLN0-KILLN3	0.5		6.0	dB
APC pull-in range (+)	PULIN+_N		350			Hz
APC pull-in range (-)	PULIN-_N				-350	Hz
Tint center	TINCEN		-10	0	10	deg
Tint variable range (+)	TINT+		35			deg
Tint variable range (-)	TINT-				-35	deg
Cr Output amplitude	CBCR-R	CbCr_IN=1 ,Cross B/W=01	2.1		4.3	Vp-p
Cb Output amplitude	CBCR-B	CbCr_IN=1 ,Cross B/W=01	1.8		3.7	Vp-p
[Filter block]:Chroma BPF Characteristic						
C-BPF1A (3.93MHz)	CBPF1A	Reference: 4.43MHz C.Filter.Sys:10	-6.0	-3.0	-1.0	dB
C-BPF1B (4.73/4.13MHz)	CBPF1B	Reference: 4.13MHz C.Filter.Sys:10	-2.5	1.5	5.5	dB
C-BPF1C (4.93/3.93MHz)	CBPF1C	Reference: 3.93MHz C.Filter.Sys:10	-3.5	2.0	7.5	dB
C-BPF2A (3.93MHz)	CBPF2A	Reference: 4.43MHz C.Filter.Sys:11	-6.0	-3.0	-1.0	dB
C-BPF2B (4.73/4.13MHz)	CBPF2B	Reference: 4.13MHz C.Filter.Sys:11	-4.0	0.0	4.0	dB
C-BPF2C (4.93/3.93MHz)	CBPF2C	Reference: 3.93MHz C.Filter.Sys:11	-5.5	0.0	5.5	dB

LV76213A2C

Parameter	Symbol	Conditions	min	typ	max	Unit
[Deflection block]						
Horizontal free-running frequency	FH		15470	15670	15870	Hz
Horizontal pull-in range	FH PULL		±400			Hz
Horizontal output pulse width	H duty		36.1	37.6	39.1	μs
Horizontal output pulse saturation voltage	V Hsat		0	0.2	0.4	V
Vertical free-running cycle 50	VFR50		312.0	312.5	313.0	H
Vertical free-running cycle 60	VFR60		262.0	262.5	263.0	H
Horizontal output pulse phase	HPHCENpal		3.8	5.8	7.8	μs
Horizontal output pulse phase	HPHCENnt		3.8	5.8	7.8	μs
Horizontal position adjustment range	HPH range	5bit		±1.8		μs
Horizontal position adjustment maximum variability width	HPH step				180.0	ns
Horizontal blanking left @0	BLKL0	H.BLK.L:000	8000	9000	10000	ns
Horizontal blanking left @7	BLKL7	H.BLK.L:111	11500	12500	13500	ns
Horizontal blanking right @0	BLKR0	H.BLK.R:000	-1600	-600	400	ns
Horizontal blanking right @7	BLKR7	H.BLK.R:111	1800	2800	3800	ns
Sand castle pulse crest value H	SANDH		5.3	5.6	5.9	V
Sand castle pulse crest value M1	SANDM1		3.7	4.0	4.3	V
Sand castle pulse crest value L	SANDL		0.0	0.4	5.0	V
Burst gate pulse width	BGPWD		3	4	5	μs
Burst gate pulse phase	BGPPH		4.7	5.2	5.9	μs
Horizontal output stop voltage	H stop		3.30	3.60	3.90	V
Horizontal phase bow correction @16	HBOW16		-0.5	0	0.5	μs
Horizontal phase bow correction @0	HBOW0		0.7	1.2	1.7	μs
Horizontal phase bow correction @31	HBOW31		-1.5	-1.0	-0.5	μs
Horizontal phase angle correction @16	HANG16		-0.5	0	0.5	μs
Horizontal phase angle correction @0	HANG0		0.4	0.9	1.4	μs
Horizontal phase angle correction @31	HANG31		-1.3	-0.8	-0.3	μs
<Vertical screen size adjustment>						
Vertical ramp output amplitude PAL @64	Vspal64	V.SIZE:1000000	0.75	1.05	1.35	Vp-p
Vertical ramp output amplitude NTSC @64	Vsnt64	V.SIZE:1000000	0.75	1.05	1.35	Vp-p
Vertical ramp output amplitude PAL @0	Vspal0	V.SIZE:0000000	0.30	0.60	0.9	Vp-p
Vertical ramp output amplitude NTSC @0	Vsnt0	V.SIZE:0000000	0.30	0.60	0.9	Vp-p
Vertical ramp output amplitude PAL @127	Vspal127	V.SIZE:1111111	1.25	1.55	1.85	Vp-p
Vertical ramp output amplitude NTSC @127	Vsnt127	V.SIZE:1111111	1.25	1.55	1.85	Vp-p
<Vertical screen position adjustment>						
Vertical ramp DC voltage @32	Vdc32	V.DC:10000	2.10	2.40	2.70	Vdc
Vertical ramp DC voltage @0	Vdc0	V.DC:00000	1.80	2.10	2.40	Vdc
Vertical ramp DC voltage @63	Vdc63	V.DC:11111	2.55	2.85	3.15	Vdc
Vertical position @8	Vshift8	V.SHIFT:1000	500	550	600	μs
Vertical position @0	Vshift0	V.SHIFT:0000	0	50	100	μs
Vertical position @15	Vshift15	V.SHIFT:1111	950	1000	1050	μs
<High-voltage dependent vertical size correction>						
Vertical size Correction @0	Vpsizecomp	V.COMP:000	0.89	0.93	0.97	ratio
<Vertical screen linearity adjustment>						
Vertical linearity @16	Vlin16	V.LIN:10000	0.7	1.00	1.30	ratio
Vertical linearity @0	Vlin0	V.LIN:00000	1.30	1.60	1.90	ratio
Vertical linearity @31	Vlin31	V.LIN:11111	0.35	0.65	0.95	ratio
Vertical S-shaped correction @16	Vscor16	V.SC:10000	0.70	1.00	1.30	ratio
Vertical S-shaped correction @0	Vscor0	V.SC:00000	1.10	1.40	1.70	ratio
Vertical S-shaped correction @31	Vscor31	V.SC:11111	0.30	0.60	0.90	ratio
<High-voltage dependent horizontal size correction>						
Horizontal size correction @0	H size comp	H.COMP:000	0.18	0.28	0.38	V

LV76213A2C

Parameter	Symbol	Conditions	min	typ	max	Unit
<Horizontal screen size adjustment>						
East/West DC Voltage@64	EWdc64	EWDC:1000000	1.90	2.40	2.90	Vdc
East/West DC Voltage@0	Ewdc0	EWDC:0000000	0.90	1.40	1.90	Vdc
East/West DC Voltage@127	Ewdc127	EWDC:1111111	2.90	3.40	3.90	Vdc
<Pincushion correction>						
East/West amplitude@64	EWamp64	EWDC:1111111 EWAMP:1000000	1.60	2.10	2.60	Vp-p
East/West amplitude@0	EWamp0	EWDC:1111111 EWAMP:0000000	-0.5	0.00	0.50	Vp-p
East/West amplitude@127	EWamp127	EWDC:1111111 EWAMP:1111111	2.10	2.60	3.10	Vp-p
<Trapezoidal distortion compensation>						
East/West tilt@64	Ewtilt64	EWDC:1111111,EWCORSW:1 EWTILT:1000000	-0.20	0.30	0.80	V
East/West tilt@0	Ewtilt0	EWDC:1111111,EWCORSW:1 EWTILT:0000000	-1.10	-0.60	-0.10	V
East/West tilt@127	Ewtilt127	EWDC:1111111,EWCORSW:1 EWTILT:1111111	0.80	1.30	1.80	V
<Corner distortion compensation>						
East/West corner top	EWcorTOP	EWDC:1111111,EWCORSW:1 EWCORTOP:00000-11111	0.35	0.90	1.45	V
East/West corner bottom	EWcorBOT	EWDC:1111111,EWCORSW:1 EWCORBOTTOM: 00000-11111	0.80	1.35	1.90	V







LV76213A2C

Test Conditions at $T_a=25^{\circ}\text{C}$, $I_{CC}=I_9=10\text{mA}$, $I_{CC}=I_{20}=11\text{mA}$, $I_{CC}=I_{49}=22\text{mA}$, $V_{CC}=V_{62}=V_4=5.0\text{V}$

Parameter	Symbol	Test point	Input signal	Test method	Bus conditions
[Circuit voltage,current]					
Horizontal supply voltage (pin 20)	V ₂₀	20	No signal	Apply a current of 13mA to pin 20 and measure the voltage at pin 20.	Initial
Logic supply voltage (pin 9)	V ₉	9	No signal	Apply a current of 11mA to pin 9 and measure the voltage at pin 9.	Initial
RGB supply voltage(pin 49)	I ₄₉	49	No signal	Apply a current of 22mA to pin 49 and measure the voltage (V) at pin49.	Initial
IF supply current(pin 62)	I ₆₂	62	No signal	Apply a voltage of 5.0V to pin 62 and measure the incoming DC current (mA). (IF AGC 2.5V applied)	Initial
Video / vertical supply current (pin 4)	I ₄	4	No signal	Apply a voltage of 5.0V to pin 4 and measure the incoming DC current (mA).	Initial

• VIF Block Input Signals and Test Conditions

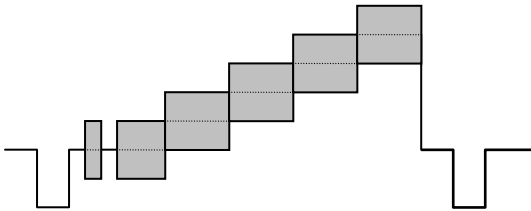
- Input signals must be input to the PIF IN (pin 56) in the Test Circuit.
- Input signal voltage values are the levels at the VIF IN (pin 56) in the Test Circuit.
- Signal contents and signal levels
- Bus control condition: VIF SYS:"001", S.TRAP.SW:"1", OVER.MOD.SW:"0", SVO.SW:"0"

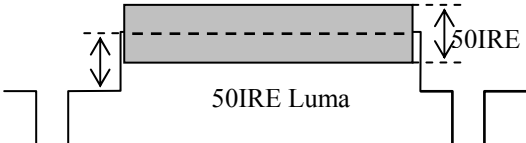
Input signal	Waveform	Conditions
SG1		38.9MHz
SG2		34.47MHz
SG3		33.4MHz
SG4		Frequency variable
SG5		38.9MHz 87.5% Video Mod. 10-stairstep wave (Subcarrier: 4.43MHz)
SG6		38.9MHz fm=15kHz,AM=78%
SG7		38.9MHz, 90dBu 87.5% Video Mod. 50IRE Luma (Carrier: variable)

Parameter	Symbol	Test point	Input signal	Test method	Bus conditions
[VIF block]					
Maximum RF AGC voltage	VRFH	58	SG1 80dBμ	Measure the DC voltage at pin 58.	RF.AGC="000000"
Minimum RF AGC voltage	VRFL	58	SG1 80dBμ	Measure the DC voltage at pin 58.	RF.AGC="111111"
RF AGC Delay Pt (@DAC=0)	RFAGC0	58	SG1	Obtain the input level at which the DC voltage at pin 58 becomes 2.5V.	RF.AGC="000000"
RF AGC Delay Pt (@DAC=63)	RFAGC63	58	SG1	Obtain the input level at which the DC voltage at pin 58 becomes 2.5V.	RF.AGC="111111"
Input sensitivity	Vi	61	SG6	Using an oscilloscope, observe the level at pin 61 and obtain the input level at which the waveform's amplitude becomes 1.4Vp-p.	
Sync tip level	V _{Otip}	61	SG1 80dBμ	Measure the DC voltage at pin 61.	
Video output amplitude	V _O	61	SG6 80dBμ	Using an oscilloscope, observe the level at pin 61 and measure the waveform's p-p value.	
Video S/N	S/N	61	SG1 80dBμ	Measure the noise voltage (V _{sn}) at pin 61 with an RMS voltmeter through a 10kHz to 5.0MHz band-pass filter and calculate 20log(1.43/V _{sn}).	
C-S beat level	IC-S	61	SG1 SG2 SG3	Input a 80dBμ SG1 signal and measure the DC voltage (V60) at pin 60. Mix SG1=74dBμ, SG2=64dBμ, and SG3=64dBμ to enter the mixture in the VIF IN. Apply V60 to pin 60 from an external DC power supply. Using a spectrum analyzer, measure the difference between pin 61's 4.43MHz component and 1.07MHz component.	
Differential gain	DG	61	SG5 80dBμ	Using a vector scope, measure the level at Pin 61.	
Differential phase	DP	61	SG5 80dBμ	Using a vector scope, measure the level at Pin 61.	
APC pull-in range (U),(L)	fPU, fPL	61	SG4 80dBμ	Connect an oscilloscope to pin 61 and adjust the SG4 frequency to a frequency higher than 38.9MHz to bring the PLL into unlocked mode. (A beat signal appears.) Lower the SG4 frequency and measure the frequency at which the PLL locks again. In the same manner, adjust the SG4 frequency to a lower frequency to bring the PLL into unlocked mode. Higher the SG4 frequency and measure the frequency at which the PLL locks again.	
NT Trap1 (4.5MHz)	NTR1	61	SG7	Determine the output level difference between carrier frequencies of 1MHz and 4.5MHz.(Reference:1MHz)	SIF.SYS="00"
BG Trap 1 (5.5MHz)	BTR1	61	SG7	Determine the output level difference between carrier frequencies of 1MHz and 5.5MHz.(Reference:1MHz)	SIF.SYS="01"
I Trap1 (6.0MHz)	ITR1	61	SG7	Determine the output level difference between carrier frequencies of 1MHz and 6.0MHz.(Reference:1MHz)	SIF.SYS="10"
DK Trap1 (6.5MHz)	DTR1	61	SG7	Determine the output level difference between carrier frequencies of 1MHz and 6.5MHz.(Reference:1MHz)	SIF.SYS="11"

•SIF Block (FM block) Input Signals and Test Conditions

Unless otherwise specified, the following conditions apply when each measurement is made.

1. Bus control condition: IF.AGC.SW="1", SIF.SYS="01", DEEM-TC="0", FM.GAIN="0"
2. SW: IF1="ON", pin 19=5V
3. Input signals are input to pin 52 and the carrier frequency is 5.5MHz.

Parameter	Symbol	Test point	Input signal	Test method	Bus conditions
FM detection output voltage	SOADJ	64	90dBμ, fm=400Hz, FM=±50kHz	Measure the 400 Hz component (SV1:mVrms) of the FM detection output at pin 64.	
FM limiting sensitivity	SLS	64	fm=400Hz, FM=±50kHz	Measure the input level (dBμ) at which the 400Hz component of the FM detection output at pin 64 becomes -3dB relative to SV1.	
FM detection output f characteristics (fm=100kHz)	SF	64	90dBμ, fm=100kHz FM=±50kHz	Set SW: IF1="OFF". Measure (SV2: mVrms) the FM detection output of pin 64. Calculate as follows: SF=20log(SV1/SV2) [dB]	
FM detection output distortion	STHD	64	90dBμ, fm=400Hz, FM=±50kHz	Measure the distortion factor of the 400Hz component of the FM detection output at pin 64.	
SIF.S/N	SSN	64	90dBμ, CW	Measure the noise level (DIN AUDIO, SV4:mVrms) at pin 64. Calculate as follows: SSN=20log(SV1/SV4) [dB]	

•Audio Block Input Signals and Test Conditions

Unless otherwise specified, the following conditions apply when each measurement is made.

1. Bus control condition:

Audio Mute : "0", A.MONI.SW: "1", FM MUTE: "1", Audio SW : "00",
 Surr cont: "0", VOL FIL: "0", Tone VOL FIL: "1", IF.AGC: "1",
 MONO Mode: "0", Volume (L/MONO): "0000000", Volume(R): "0000000", Tone ATT: "0",
 T Boost/Cut: "0", Treble gain: "1111111", B Boost/Cut: "0", Bass Gain: "1111111"

2. Enter an input signal EXT-LIN from pin 2.
3. Enter an input signal EXT-RIN from pin 1.
4. Output signal LOU is output to pin 50.
5. Output signal ROU is output to pin 51.

Parameter	Symbol	Test point	Input signal	Test method	Bus conditions
[AUDIO block]					
Volume gain (Stereo mode)	AVGT	50	EXT-LIN(2PIN) =1kHz,300mVrms	Measure the 1kHz component (V1:mVrms) at the LOU(50PIN) and calculate as follows: AVGT=20log(V1/300) [dB]	
Maximum output voltage (Stereo mode)	AVOT	2	EXT-LIN(2PIN) =1kHz	When the distortion (D _{IN} .AUDIO) of the LOU(pin50) is 1%, Measure the voltage level at the EXT-LIN (pin 2).	
Frequency characteristic (Stereo mode)	AFREQT	2	EXT-LIN(2PIN) =300mVrms	Measure the voltage level (V2:mVrms) at the LOU(pin50) and calculate as follows: AFT=20log(V2/300) [dB] When the AFT is -3dB, Measure the frequency at the EXT-LIN (pin 2).	
Total harmonic distortion (Stereo mode)	ATHDT	50	EXT-LIN(2PIN) =1kHz,300mVrms	Measure the distortion (D _{IN} .AUDIO) of the 1kHz component at the LOU (50PIN).	
Output voltage noise (Stereo mode)	ANOT	50	No signal	Measure the noise level (D _{IN} AUDIO) at the LOU (pin50).	
Cross talk (Stereo mode)	ACTT	51	EXT-LIN(2PIN) =1kHz,300mVrms	Measure the 1kHz component (V3:mVrms) at the ROU (pin51) and calculate as follows: ACTT=20log(V3/300) [dB]	
Volume gain (Mono mode)	AVGM	50	EXT-LIN(2PIN) =1kHz,300mVrms	Measure the 1kHz component (V4:mVrms) at the LOU (pin50) and calculate as follows: AVGM=20log(V4/300) [dB]	Audio SW=10 Mono Mode=1
Maximum output voltage (Mono mode)	AVOM	2	EXT-LIN(2PIN) =1kHz	When the distortion (D _{IN} .AUDIO) of the LOU(pin50) is 1%, Measure the voltage level at the EXT-LIN (PIN 2).	Audio SW=10 Mono Mode=1
Frequency characteristic (Mono mode)	AFREQM	2	EXT-LIN(2PIN) =300mVrms	Measure the voltage level (V5:mVrms) at the LOU (pin50) and calculate as follows: AFM=20log(V5/300) [dB] When the AFM is -3dB, Measure the frequency at the EXT-LIN (PIN 2).	Audio SW=10 Mono Mode=1
Total harmonic distortion (Mono mode)	ATHDM	50	EXT-LIN(2PIN) =1kHz,300mVrms	Measure the distortion (D _{IN} .AUDIO) of the 1kHz component at the LOU (pin50).	Audio SW=10 Mono Mode=1
Output voltage noise (Mono mode)	ANOM	50	No signal	Measure the noise level (D _{IN} AUDIO) at the LOU (50PIN).	Mono Mode=1
Maximum output voltage (Surround mode)	AVOS	2	EXT-LIN(2PIN) =1kHz (phase 180 deg)	When the distortion (D _{IN} .AUDIO) of the LOU (PIN 50) is 1%. Measure the voltage level at the LIN (PIN 2).	Surr cint:11 (MODE-C)
Total harmonic distortion (Surround mode)	ATHDS	50	EXT-LIN(2PIN) EXT-RIN(PIN1) =1kHz (phase 180 deg) 300mVrms	Measure the distortion (D _{IN} .AUDIO) of the 1kHz component at the LOU (pin50).	Surr cint:11 (MODE-C)
Output voltage noise (Surround mode)	ANOS	50	No signal	Measure the noise (D _{IN} .AUDIO) at the LOU (pin50).	Surr cint:11 (MODE-C)
Bass band control range	AGEQB	50	EXT-LIN(2PIN) =100Hz, 100mVrms	Measure the 100Hz component (V6:mVrms) at the LOU(PIN 50) and calculate as follows: AGEQB=20log(V6/300)[dB]	B Boost/Cut:1,0 Bass Gain :000000(12dB)
Treble band control range	AGEQT	50	EXT-LIN(2PIN) =10kHz, 100mVrms	Measure the 10kHz component (V7:mVrms) at the LOU(PIN 50) and calculate as follows: AGEQT=20log(V7/300)[dB]	T Boost/Cut:1,0 Treble Gain :000000(12dB)
Mute	AMUTE	50	EXT1-LIN(2PIN) EXT2-LIN(8PIN) =1kHz,300mVrms	Measure the 1kHz component (V8:mVrms) at the LOU (PIN50) and calculate as follows: AMUTE =20log(V8/300) [dB]	Audio.mute=1
L/R Balance	ABT	51	EXT1-LIN(2PIN) EXT1-RIN(1PIN) EXT2-LIN(8PIN) EXT2-RIN(7PIN) =1KHz,300mVrms	Measure the 1KHz component(V9:mVrms) at the ROU (PIN51) and calculate as follows: ABT=20Log(V1/V9) [dB]	

• Video Block Input Signals and Test Conditions

- 1, C IN Input*chroma burst signal: 40 IRE
- 2, Y IN input signal 100IRE:714mV
- 3, Bus control bit conditions: Initial test state

· 10IRE signal (L-0): NTSC standard sync signal

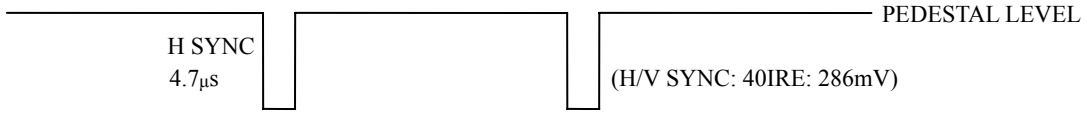

· XIRE signal (L-X)

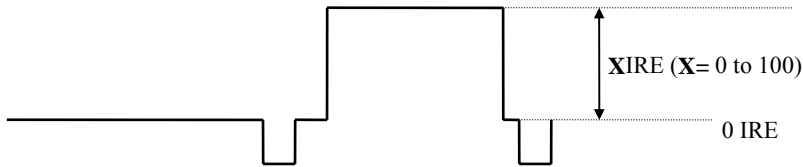

· CW signal (L-CW)

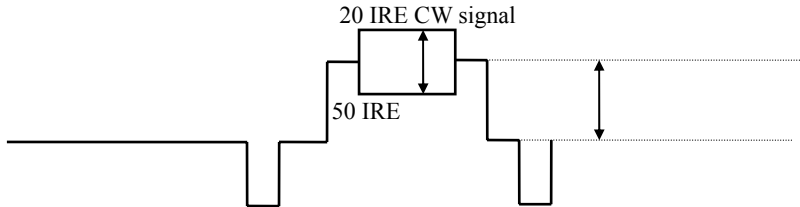

· BLACK STRETCH A point (0IRE to 99IRE) signal (L-BK)

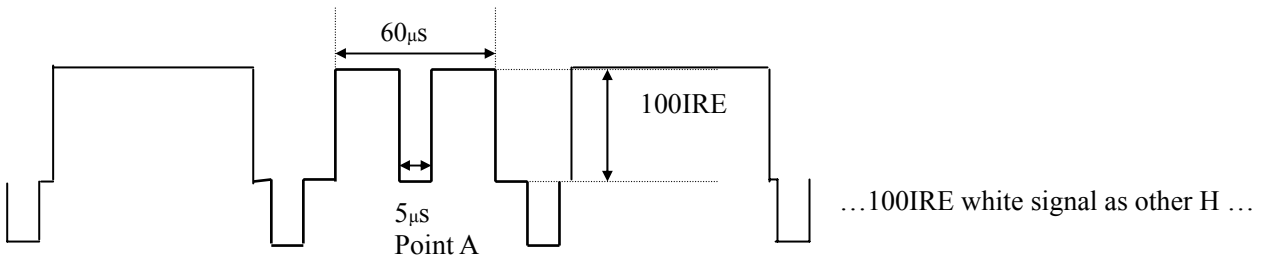

· R/G/B IN Input signal

· RGB Input signal 1 (0-1)

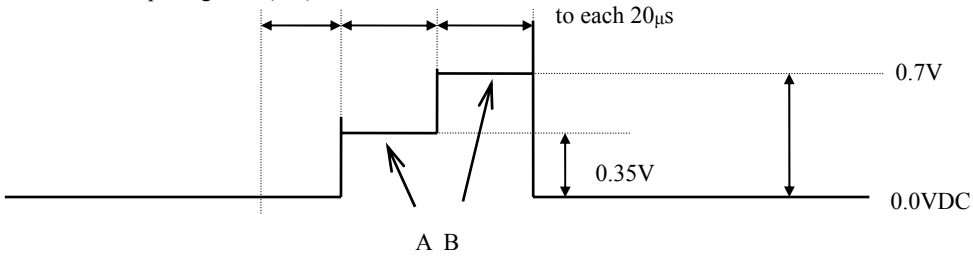

· RGB Input signal 2 (0-2)

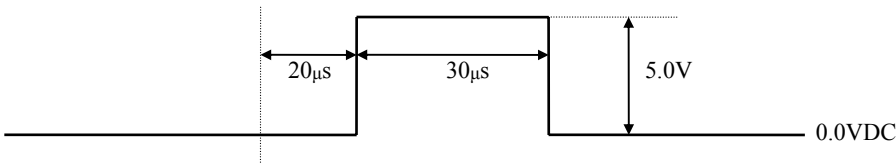

LV76213A2C

Parameter	Symbol	Test point	Input signal	Test method	Bus conditions
[Video block]					
Video overall gain (Contrast max)	CONT127	46	L-50	Measure the output signal's 50IRE amplitude (CNTHB Vp-p) and calculate CONT127= 20log (CNTHB/0.357).	CONTRAST:1111111 Y Gamma Start=11
Contrast adjustment characteristics (normal/max)	CONT64	46	L-50	Measure the output signal's 50IRE amplitude (CNTCB Vp-p) and calculate CONT63= 20log (CNTCB/CNTHB).	CONTRAST:1000000 Y Gamma Start=11
Contrast adjustment characteristics (min/max)	CONT0	46	L-50	Measure the output signal's 50IRE amplitude (CNTLB Vp-p) and calculate CONT0=20log (CNTLB/CNTHB).	CONTRAST:0000000 Y Gamma Start=11
Video frequency Characteristics 1 (NTSC)	BW1	46	L-CW	With the input signal's continuous wave=100kHz, measure the output signal's continuous wave amplitude (PEAKDC Vp-p). With the input signal's continuous wave=1.8MHz, measure the output signal's continuous wave amplitude (CW1.8 Vp-p). Calculate BW1=20Log (CW1.8/PEAKDC).	Y Filter.sys:00 SHARPNESS: 000000 Y Gamma Start=11
Video frequency Characteristics 2 (PAL)	BW2	46	L-CW	With the input signal's continuous wave=2.2MHz, measure the output signal's continuous wave amplitude (CW2.2 Vp-p). Calculate BW2=20Log (CW2.2/PEAKDC).	Y Filter.sys:01 SHARPNESS: 000000 Y Gamma Start=11
Video frequency Characteristics 3 (6MHz TRAP)	BW3	46	L-CW	With the input signal's continuous wave=2.3MHz, measure the output signal's continuous wave amplitude (CW2.3 Vp-p). Calculate BW3=20Log (CW2.3/PEAKDC).	Y Filter.sys:10 SHARPNESS: 000000 Y Gamma Start=11
Video frequency Characteristics 4 (APF)	BW4	46	L-CW	With the input signal's continuous wave=3.4MHz, measure the output signal's continuous wave amplitude (CW3.4 Vp-p). Calculate BW3=20Log (CW3.4/PEAKDC).	Y Filter.sys:00 SHARPNESS: 000000 Y APF:1 Y Gamma Start=11
Chroma trap amount PAL	CtraPP	46	L-CW	With the input signal's continuous wave=4.43MHz, measure the output signal's continuous wave amplitude (F0P Vp-p). Calculate CtraP=20Log (F0P/PEAKDC).	Y Filter.sys:01 Sharpness: 000000 Y Gamma Start=11
Chroma trap amount NTSC	CtraPN	46	L-CW	With the input signal's continuous wave=3.58MHz, measure the output signal's continuous wave amplitude (F0N Vp-p). Calculate CtraN=20Log (F0N/PEAKDC).	Y Filter.sys:00 Sharpness: 000000 Y Gamma Start=11
DC restoration rate 1	ClampG1	46	L-0	Measure the output signal's 0IRE DC level (BRTPL V).	Sub.Bais:1111111 CONTRAST:0111111
			L-100	Measure the output signal's 0IRE DC level(DRVPH V) and 100IRE amplitude (DRVH Vp-p) and calculate ClampG=100×(1+(DRVPH-BRTPL)/DRVH).	Sub.Bais:1111111 Contrast:0111111 DCREST=00 BLK.STR.START=11 WPL=0
DC restoration rate 2	ClampG2	46	L-100	With DCREST = 01, carry out measurement similarly to the case of the DC restoration rate 1.	DCREST =01
DC restoration rate 3	ClampG3	46	L-100	With DCREST = 10, carry out measurement similarly to the case of the DC restoration rate 1.	DCREST =10
DC restoration rate 4	ClampG4	46	L-100	With DCREST = 11, carry out measurement similarly to the case of the DC restoration rate 1.	DCREST =11
Y-DL TIME1 (NTSC)	TdY1	46	L-50	Obtain the time difference (the delay time) from when the rise of the input signal's 50IRE amplitude to the output signal's 50IRE amplitude.	Y Filter.sys:00 YDELAY Ajust:100
Y-DL TIME2 (PAL)	TdY2	46	L-50	Obtain the time difference (the delay time) from when the rise of the input signal's 50IRE amplitude to the output signal's 50IRE amplitude.	Y Filter.sys:01 YDELAY Ajust:100
Y-DL TIME3	TdY3	46	L-50	Obtain the time difference (the delay time) from when the rise of the input signal's 50IRE amplitude to the output signal's 50IRE amplitude.	Y Filter.sys:11 YDELAY Ajust:100 Delay Test:1
Y-DL TIME4 (6MHz TRAP)	TdY4	46	L-50	Obtain the time difference (the delay time) from when the rise of the input signal's 50IRE amplitude to the output signal's 50IRE amplitude.	Y Filter.sys:10 YDELAY Ajust:100
Y-DL TIME Ajust1	TdYa1	46	L-50	Obtain the time difference (the delay time) from when the rise of the input signal's 50IRE amplitude to the output signal's 50IRE amplitude.	Y Filter.sys:00 Y Delay Ajust:000

LV76213A2C

Parameter	Symbol	Test point	Input signal	Test method	Bus conditions
Y-DL TIME Ajust2	TdYa2	46	L-50	Obtain the time difference (the delay time) from when the rise of the input signal's 50IRE amplitude to the output signal's 50IRE amplitude.	Y Filter.sys:00 Y Delay Ajust:111
Black stretch gain (MAX)	BKST max	46	L-BK (A=0IRE)	Measure the 0IRE DC level(BKST1 V) at point A of the output signal in the Black Stretch Defeat (Black Stretch OFF) mode	Blk.str.start=11 Y Filter.sys:10
				Measure the 0IRE DC level(BKST2 V) at point A of the output signal in the Black Stretch ON mode. Calculate $BKST\ max=50 \square (BKST1-BKST2)/CNTHB$.	Blk.str.gain=10 Blk.str.start=01 Y Filter.sys:10
Black stretch gain (MID)	BKST mid	46	L-BK (A=0IRE)	With Blk.str.gain = 01, carry out the same measurement as for the case of black stretch gain (MAX).	Blk.str.gain=01 Blk.str.start=01 Y Filter.sys:10
Black stretch gain (MIN)	BKST min	46	L-BK (A=0IRE)	With Blk.str.gain = 00, carry out the same measurement as for the case of black stretch gain (max).	Blk.str.gain=00 Blk.str.start=01 Y Filter.sys:10
Black stretch start max (60IRE ΔBlack)	BKSTTH max	46	L-BK (A=60IRE)	Measure the 60IRE DC level (BKST3 V) at point A of the output signal in the Black Stretch ON mode.	Blk.str.gain=01 Blk.str.start=10 Y Filter.sys:10
				Measure the 60IRE DC level (BKST4 V) at point A of the output signal in the Black Stretch Defeat (Black Stretch OFF) mode. Calculate $BKSTTH\ max=50 \square (BKST4-BKST3)/CNTHB$.	Blk.str.gain=00 Blk.str.start=11 Y Filter.sys:10
Black stretch start mid (50IRE ΔBlack)	BKSTTH mid	46	L-BK (A=50IRE)	Measure the 50IRE DC level (BKST5 V) at point A of the output signal in the Black Stretch Defeat ON mode.	Blk.str.gain=01 Blk.str.start=01 Y Filter.sys:10
				Calculate $BKSTTH\ mid=50 \square (BKST6-BKST5)/CNTHB$.	Blk.str.gain=00 Blk.str.start=11 Y Filter.sys:10
Black stretch start min (40IRE ΔBlack)	BKSTTH min	46	L-BK (A=40IRE)	Measure the 40IRE DC level (BKST7 V) at point A of the output signal in the Black Stretch Defeat ON mode.	Blk.str.gain=01 Blk.str.start=00 Y Filter.sys:10
				Measure the 40IRE DC level (BKST8 V) at point A of the output signal in the Black Stretch Defeat (Black Stretch OFF) mode. Calculate $BKSTTH\ min=50 \square (BKST8-BKST7)/CNTHB$.	Blk.str.gain=00 Blk.str.start=11 Y Filter.sys:10
Sharpness variable range (NTSC)	Sharp32T1	46	L-CW	With the input signal's continuous wave=2.2MHz, measure the output signal's continuous wave amplitude (F01S32 Vp-p). Calculate $Sharp32T1=20\text{Log}(F01S32/PEAKDC)$.	Y Filter.sys:00 Sharpness: 100000 Y Gamma Start=11 C_Kill.ON=1
(max)	Sharp63T1	46	L-CW	With the input signal's continuous wave=2.2MHz, measure the output signal's continuous wave amplitude (F01S63 Vp-p). Calculate $Sharp63T1=20\text{Log}(F01S63/PEAKDC)$.	Y Filter.sys:00 Sharpness: 111111 Y Gamma Start=11 C_Kill.ON=1
(min)	Sharp0T1	46	L-CW	With the input signal's continuous wave=2.2MHz, measure the output signal's continuous wave amplitude (F01S0 Vp-p). Calculate $Sharp0T1=20\text{Log}(F01S0/PEAKDC)$.	Y Filter.sys:00 Sharpness: 000000 Y Gamma Start=11 C_Kill.ON=1
Sharpness variable range (PAL)	Sharp32T2	46	L-CW	With the input signal's continuous wave=2.7MHz, measure the output signal's continuous wave amplitude (F02S32 Vp-p). Calculate $Sharp32T2=20\text{Log}(F02S32/PEAKDC)$.	Y Filter.sys:01 Sharpness: 100000 Y Gamma Start=11 C_Kill.ON=1
(max)	Sharp63T2	46	L-CW	With the input signal's continuous wave=2.7MHz, measure the output signal's continuous wave amplitude (F02S63 Vp-p). Calculate $Sharp63T2=20\text{Log}(F02S63/PEAKDC)$.	Y Filter.sys:01 Sharpness: 111111 Y Gamma Start=11 C_Kill.ON=1
(min)	Sharp0T2	46	L-CW	With the input signal's continuous wave=2.7MHz, measure the output signal's continuous wave amplitude (F02S0 Vp-p). Calculate $Sharp0T2=20\text{Log}(F02S0/PEAKDC)$.	Y Filter.sys:01 Sharpness: 000000 Y Gamma Start=11 C_Kill.ON=1

LV76213A2C

Parameter	Symbol	Test point	Input signal	Test method	Bus conditions
Sharpness variable range (6MHz TRAP)	Sharp32T4	46	L-CW	With the input signal's continuous wave=3.0MHz, measure the output signal's continuous wave amplitude (F04S32 Vp-p). Calculate Sharp32T4=20Log (F04S32/PEAKDC).	Y Filter.sys:10 Sharpness: 100000 Y Gamma Start=11 C_Kill.ON=1
(max)	Sharp63T4	46	L-CW	With the input signal's continuous wave=3.0MHz, measure the output signal's continuous wave amplitude (F04S63 Vp-p). Calculate Sharp63T4=20Log (F04S63/PEAKDC).	Y Filter.sys:10 Sharpness: 111111 Y Gamma Start=11 C_Kill.ON=1
(min)	Sharp0T4	46	L-CW	With the input signal's continuous wave=3.0MHz, measure the output signal's continuous wave amplitude (F04S0 Vp-p). Calculate Sharp0T4=20Log (F04S0/PEAKDC).	Y Filter.sys:10 Sharpness: 000000 Y Gamma Start=11 C_Kill.ON=1
White peak limiter operating point 1	WPL1	46	L-100	Measure the amplitude (from pedestal to white) of the output signal with WPL=00. (PIN 45: 5V) Bigger the input signal and measure the amplitude (from pedestal to white) of the output signal at which the output signal is clipped. (WP1) WPL1=WP1/CNTCB1*100	WPL=00 Y Gamma Start=11
White peak limiter operating point 2	WPL2	46	L-100	Bigger the input signal and measure the amplitude(from pedestal to white) of the output signal at which the output signal is clipped with WPL=01. (WP2) WPL2=WP2/CNTCB1*100	WPL=01 Y Gamma Start=11
White peak limiter operating point 3	WPL3	46	L-100	Bigger the input signal and measure the amplitude(from pedestal to white) of the output signal at which the output signal is clipped with WPL=10. (WP3) WPL3=WP3/CNTCB1*100	WPL=10 Y Gamma Start=11
White peak limiter operating point 4	WPL4	46	L-100	Bigger the input signal and measure the amplitude(from pedestal to white) of the output signal at which the output signal is clipped with WPL=11. (WP4) WPL4=WP4/CNTCB1*100	WPL=11 Y Gamma Start=11
Y gamma start effective point1	YGST1	46	L-100	Measure the amplitude of the output signal (0 to 100IRE) with Y GAMMA START=3.Y GAMMA GAIN=0. (GAM0)	Y Gamma GAIN=00 Y Gamma Start=11
			L-50	Next measure the amplitude the output signal (0 to 50IRE) with Y GAMMA START=1. Y GAMMA GAIN=1(GAM1) and calculate YGS1= GAM1/GAM0*100	Y Gamma GAIN=01 Y Gamma Start=00
Y gamma start effective point12	YGST2	46	L-50	Measure the amplitude of the output signal (0 to 50IRE) with Y GAMMA START=1. Y GAMMA GAIN=1 (GAM2) and calculate YGS2= GAM2/GAM0*100	Y Gamma GAIN=01 Y Gamma Start=01
Y gamma start effective point1	YGST3	46	L-50	Measure the amplitude of the output signal (0 to 50IRE) (GAM3) and calculate YGS3= GAM3/GAM0*100	Y Gamma GAIN=01 Y Gamma Start=10
Y gamma gain 1	YGGA1	46	L-50	Measure the amplitude of the output signal (0 to 50IRE).(GGAM1)	Y Gamma Start =01
			L-100	Measure the amplitude of the output signal (0 to 100IRE).(GGAM2) Calculate YGG1=100*GGAM1/(GGAM2-GGAM1)	Y Gamma GAIN=00
Y gamma gain 2	YGGA2	46	L-50	Measure the amplitude of the output signal (0 to 50IRE).(GGAM3)	Y Gamma Start =01
			L-100	Measure the amplitude of the output signal (0 to 100IRE).(GGAM4) Calculate YGG2=100*GGAM3/(GGAM4-GGAM3)	Y Gamma GAIN=01
Y gamma gain 3	YGGA3	46	L-50	Measure the amplitude of the output signal (0 to 50IRE) .(GGAM5)	Y Gamma Start =01
			L-100	Measure the amplitude of the output signal (0 to 100IRE).(GGAM6) Calculate YGG3=100*GGAM5/(GGAM6-GGAM5)	Y Gamma GAIN=10
GRAY MODE LEVEL	GRAY	46		Measure the DC level(deviation from pedestal)of pin46, and transfer IRE.	CROSS B/W:10 GRAY MODE:1
Horizontal/vertical blanking output level	RGBBLK	46	L-100	Measure the DC level (RGBBLK V) for the output signal's blanking period.	
Pre-shoot adjust1	PreShoot1	46	L-100	Measure the pre-shoot width (Tpre) and over-shoot width (Tover) at rise of 100IRE amplitude of the output signal, and calculate PreShoot = Tpre / Tover.	Pre-shoot adj.=00 Y Filter.sys:00 Sharpness=111111
Pre-shoot adjust2	PreShoot2	46	L-100	With Pre-shoot adj. = 11, carry out the same measurement as for the case of Pre-Shoot 1.	Pre-shoot adj.=11 Y Filter.sys:00 Sharpness=111111

LV76213A2C

Parameter	Symbol	Test point	Input signal	Test method	Bus conditions
Over-shoot adjust	OverShoot	46	L-100	With Over-shoot adj. = 11 Measure the pre-shoot width (Tpre) and over-shoot width (Tover) at rise of 100IRE amplitude of the output signal, and calculate OverShoot = Tover/Tpre	Over-shoot adj.=11 Y Filter.sys:00 Sharpness=111111
[RGB output block] (Cutoff, drive block)		Bus control bit conditions: Contrast=127			Contrast:111111
Brightness control (normal)	BRT64	48 47 46	L-0	Measure the 0IRE DC levels of the respective output signals of R output (48), G output (47), and B output (46). Assign the measured values to BRTPCR, BRTPCG, and BRTPCB V, respectively. Calculate $BRT63 = (BRTPCR + BRTPCG + BRTPCB) / 3$	Bright: 1000000
Brightness control (normal-H)	BRT64H	46	L-0	Measure the 0IRE DC level of the output signal of B output (46) and assign the measured value to BRTPCBH.	Bright: 1000000 B.BIAS: 11111111 Sub Bias: 111111
Brightness control (max)	BRT127	46	L-0	Measure the 0IRE DC level of the output signal of B output (46) and assign the measured value to BRTPHB. Calculate $BRT127 = 50 \times (BRTPHB - BRTPCB) / CNTHB$.	Bright: 111111 B.BIAS: 11111111 Sub Bias: 111111
Brightness control (min)	BRT0	46	L-0	Measure the 0IRE DC level of the output signal of B output (46) and assign the measured value to BRTPLB. Calculate $BRT0 = 50 \times (BRTPLB - BRTPCBH) / CNTHB$.	Bright: 0000000 B.BIAS: 11111111 Sub Bias: 111111
Bias (cutoff) control (min)	Vbias0	48 47 46	L-50	Measure the 0IRE DC levels ($Vbias0 \chi V$) of the respective output signals of R output (48), G output (47), and B output (46). (χ : R, G, and B)	Sub.Bias: 111111
Bias (cutoff) control (max)	Vbias255	48 47 46	L-50	Measure the 0IRE DC levels ($Vbias255 \chi V$) of the respective output signals of R output (48), G output (47), and B output (46). (χ : R, G, and B)	Sub.Bias: 111111 R/G/B.BIAS:11111111
Bias (cutoff) control resolution	Vbiassns	48 47 46	L-50	Measure the 0IRE DC levels ($BAS80 \chi V$) of the respective output signals of R output (48), G output (47), and B output (46). (χ : R, G, and B) Measure the 0IRE DC levels ($BAS48 \chi V$) of the respective output signals of R output (48), G output (47), and B output (46). Calculate $Vbiassns \chi = (BAS80 \chi - BAS48 \chi) / 32$	R/G/B.BIAS:01010000 Sub.Bias: 111111 R/G/B.BIAS:00110000 Sub.Bias: 111111
Sub-bias control resolution	Vsbiassns	48 47 46	L-50	Set Sub.Bias 64 and measure the 0IRE DC levels ($SB64 \chi V$) of the respective output signals of R output (48), G output (47), and B output (46). and next, set Sub.Bias 42, then measure the same as before. Calculate $Vsbiassns \chi = (SB64 \chi - SB42 \chi) / 22$	Sub.Bias: 1000000/0101010 Contrast: 011111 R/G/B.BIAS:11111111
Drive adjustment maximum output	RGBout127	48 47 46	L-100	Measure the 100IRE amplitudes ($DRVH \chi Vp-p$) of the respective output signals of R output (48), G output (47) and B output (46). (χ : R, G and B)	Bright: 0000000 R/G/B DRIVE: 1111111 Contrast: 1000000
Output attenuation	RGBout0	48 47 46	L-100	Measure the 100IRE amplitudes ($DRVL \chi Vp-p$) of the respective output signals of R output (48), G output (47), and B output (46). (χ : R, G and B) Calculate $RGBout0 \chi = 20 \log(DRVH \chi / DRVL \chi)$	Bright: 0000000 R/G/B DRIVE: 0000000 Contrast: 1000000

LV76213A2C

Parameter	Symbol	Test point	Input signal	Test method	Bus conditions
[Ext.RGB Block]		Bus control bit conditions: Contrast:64, Brightness:64			Contrast:100000 Brightness:100000
Ext.RGB Fast SW threshold	FSTH	46	L-0 O-2	Apply voltage to pin 8 and measure the voltage at pin 8 at the point where the output signal switches to the Ext.RGB signal.	Pin 8: O-5 Applied $V_{IN}/Ext.RGB IN: 0$ Digital OSD:1
Ext.Red output level	REXDC	48	L-50	Measure the output signal's 50IRE amplitude (CNTCR Vp-p)	Pin 8 : 5V Pin 11A: O-2 Applied $V_{IN}/Ext.RGB IN: 0$ Digital OSD :1 EXT.RGB Contrast:1000 Ext.RBIAS:1000 Ext.RDRIVE:1000
			L-0 O-2	Measure the Ext.RGB output amplitude (EXTHR Vp-p). Calculate $REXDH=50 \times (EXTHR/CNTCR)$.	
Ext.Green output level	GEXDC	47	L-50	Measure the output signal's 50IRE amplitude (CNTCG Vp-p)	Pin 8 : 5V Pin 10A: O-2 Applied $V_{IN}/Ext.RGB IN: 0$ Digital OSD :1 EXT.RGB Contrast:1000 Ext.RBIAS:1000 Ext.RDRIVE:1000
			L-0 O-2	Measure the Ext.RGB output amplitude (EXTHG Vp-p). Calculate $GEXDH=50 \times (EXTHG/CNTCG)$.	
Ext.Blue output level	BEXDC	48	L-50	Measure the output signal's 50IRE amplitude (CNTCB Vp-p)	Pin 8 : 5V Pin 13A: O-1 Applied $V_{IN}/Ext.RGB IN: 0$ Digital OSD :1 EXT.RGB Contrast:1000 Ext.RBIAS:1000 Ext.RDRIVE:1000
			L-0 O-1	Measure the Ext.RGB output amplitude (EXTHB Vp-p). Calculate $BEXDH=50 \times (EXTHB/CNTCB)$.	
Analog Ext R output level		48	L-0 O-1	Measure the amplitudes at point A (0.35V portion of the input signal 0-1) and point B (0.7V portion of the input signal 0-1) of the output signal. Assign the measured values to RGBLR Vp-p and RGBHR Vp-p, respectively.	Pin 8 : 5V Pin 11A: O-1 Applied $V_{IN}/Ext.RGB IN: 0$ Digital OSD :0 EXT.RGB Contrast:1000 Ext.RBIAS:1000 Ext.RDRIVE:1000
			Gain match	RRGB	
	linearity	LRRGB		Calculate $LRRGB=100 \times (RGBLR/RGBHR)$.	
Analog Ext G output level		47	L-0 O-1	Measure the amplitudes at point A (0.35V portion of the input signal 0-1) and point B (0.7V portion of the input signal 0-1) of the output signal. Assign the measured values to RGBLG Vp-p and RGBHG Vp-p, respectively.	Pin 8 : 5V Pin 10A: O-1 Applied $V_{IN}/Ext.RGB IN: 0$ Digital OSD :0 EXT.RGB Contrast:1000 Ext.RBIAS:1000 Ext.RDRIVE:1000
			Gain match	GRGB	
	linearity	LGRGB		Calculate $LGRGB=100 \times (RGBLG/RGBHG)$	
Analog Ext B output level		46	L-0 O-1	Measure the amplitudes at point A (0.35V portion of the input signal 0-1) and point B (0.7V portion of the input signal 0-1) of the output signal. Assign the measured values to RGBLB Vp-p and RGBHB Vp-p, respectively.	Pin 8 : 5V Pin 10A: O-1 Applied $V_{IN}/Ext.RGB IN: 0$ Digital OSD :0 EXT.RGB Contrast:1000 Ext.RBIAS:1000 Ext.RDRIVE:1000
			Gain match	BRGB	
	linearity	LBRGB		Calculate $LBRGB=100 \times (RGBLB/RGBHB)$	

LV76213A2C

Parameter	Symbol	Test point	Input signal	Test method	Bus conditions
[VIDEO SW [Block]					
Video signal input 1DC voltage	VIN1DC	5	L-100	Input signals to pin 5 and measure the voltage of the pedestal.	Video SW:01
Video signal input 1 AC voltage	VIN1AC	5		Pin 5 recommended input level	Video SW:01
Video signal input 2DC voltage	VIN2DC	3	L-100	Input signals to pin 3 and measure the voltage of the pedestal.	Video SW:00
Video signal input 2 AC voltage	VIN2AC	3		Pin 3 recommended input level	Video SW:00
Video signal input 3DC voltage	VIN3DC	10		Input signals to pin 10 and measure the voltage of the pedestal.	Video SW:10
Video signal input 3AC voltage	VIN3AC	10		Pin 10 recommended input level	Video SW:10
Video signal input 4DC voltage	VIN4DC	7		Input signals to pin 7 and measure the voltage of the pedestal.	Video SW:11
Video signal input 4AC voltage	VIN4AC	7		Pin 7 recommended input level	Video SW:11
SVO terminal DC voltage	SVODC	61	L-100	Input signals to pin 5 and measure the voltage of the pedestal at pin 61.	Video SW:01 SVO SW:1 YCMIX:0
SVO terminal AC voltage	SVOAC	61	L-100	The signal is input to 5PIN, and the amplitude of the signal of 61PIN is measured.	VIDE0 SW:01 SVO SW:1 YCMIX:0
SVO terminal Ycmix AC Voltage	SVOYC	61	L-0 L-CW	Y signal is input to 7PIN, and C signal of 8PIN is input, and the amplitude of 61PIN (SVO) is measured.	VIDE0 SW:11 SVO SW:1 YCMIX:1

•Chroma Block Input Signals and Test Conditions

Unless otherwise specified, the following conditions apply when each measurement is made.

1. VIF, SIF blocks: No signal
2. Deflection Block: Horizontal/vertical composite sync signals are input and the deflection block must be locked into the sync signals (Refer to the Deflection Block Input Signals and the Test Conditions).
3. Bus control conditions: Set the following conditions unless otherwise specified.

Y Input is 7 Pin (YC-Y),

C Input is 8 Pin (YC-C)

(Video SW=3, C. Ext=1)

Other DAC except the above-mentioned conditions is all initial conditions.

4. Y Input condition: No signal unless otherwise specified.

(Sync is necessary to obtain synchronization).

5. How to calculate the demodulation ratio and angle:

$$B\text{-Y axis angle} = \tan^{-1}(B(0) / B(270)) + 270^\circ$$

$$R\text{-Y axis angle} = \tan^{-1}(R(180) / R(90)) + 90^\circ$$

$$G\text{-Y axis angle} = \tan^{-1}(G(270) / G(180)) + 180^\circ$$

$$B\text{-Y axis amplitude } V_b = \text{SQRT}(B(0)*B(0)+B(270)*B(270))$$

$$R\text{-Y axis amplitude } V_r = \text{SQRT}(R(180)*R(180)+R(90)*R(90))$$

$$G\text{-Y axis amplitude } V_g = \text{SQRT}(G(180)*G(180)+G(270)*G(270))$$

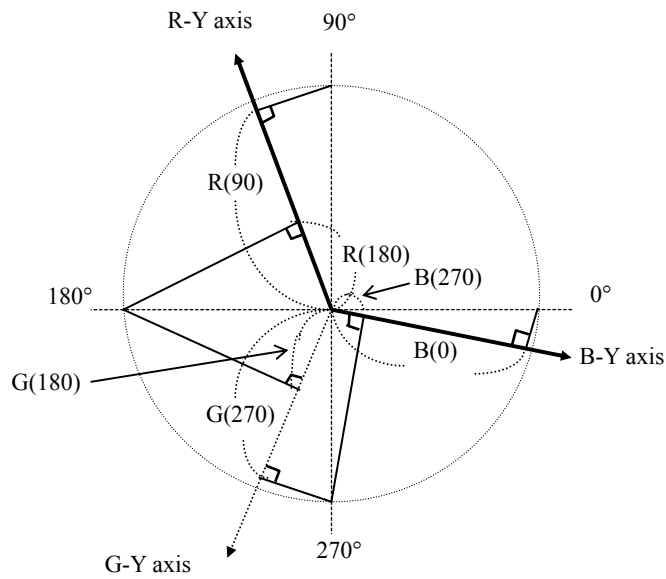

6. Chroma input signal

As for the PAL signal, the burst swings such as 135° and 225° every horizontal period.

Chroma describes the phase caused when the burst occurs at 135°.

As for the NTSC signal, the burst occurs constantly at 180°.

The figures below are based on the phase of NTSC. When a PAL signal is generated, adjust the phase and then enter signals.

The item common to both PAL and NTSC is the PAL signal. For those other than this, the measurement must be performed for each individual signals.

The condition of fsc: Set the following conditions unless otherwise specified.

PAL =4.433619MHz

NTSC =3.579545MHz

C-1

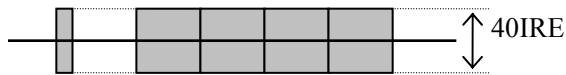

Burst 0° 90° 180° 270°
fsc

X IRE signal (L-X)

C-2

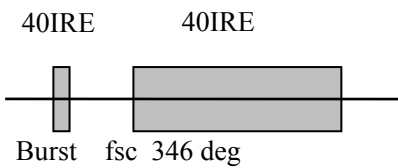

Burst fsc 346 deg

C-3

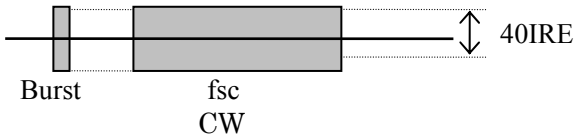

Burst fsc
CW

(Note: $fsc \pm N * fh$ when the frequency is specified.

N should be a natural number and the nearest value should be used.)

C-4

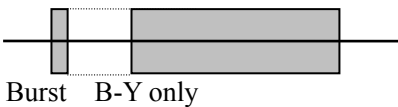

Burst B-Y only

C-5

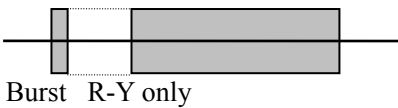

Burst R-Y only

C-6

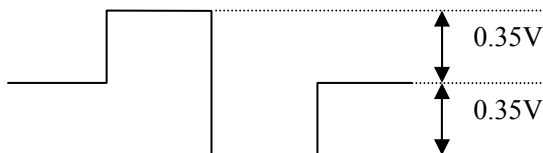

*There is no signal for H, V blanking period.

LV76213A2C

Parameter	Symbol	Test point	Input signal	Test method	Bus conditions
[Chroma block]: PAL/NTSC common					
B-Y/Y amplitude ratio	CLRBY	46	YIN:L77 CIN: No signal	Measure the Y system's output level. V_1	
			C-2	Input a signal to the C_{IN} (only sync Signal to the YIN) and measure the output level to calculate as follows: $CLRBY=100 \times (V_2/V_1)$	Color:1000000
Color control Characteristics 1	CLRMN	46	C-1	Measure the output amplitude V_1 at color Control MAX mode and output amplitude V_2 at color control CEN mode and, Calculate as follows: $CLRMN=V_1/V_2$	Color:1111111 Color:1000000
Color control Characteristics 2	CLRMM	46	C-1	Measure the output amplitude V_3 at color Control MIN mode to calculate as follows: $CLRMM=20 \log (V_1/V_3)$	Color:0000000
Color control sensitivity	CLRSE	46	C-1	Measure the output amplitude V_4 at color Control 90 mode and output amplitude V_5 at color control 38 mode to calculate as follows: $CLRSE=100 \times (V_4 - V_5)/(V_2 \times 52)$	Color:1011010 Color:0100110
Residual higher harmonic level B	E_CAR_B	46	C-1 Burst only	Measure the 8.86MHz component output amplitude at pin 46.	
Residual higher harmonic level G	E_CAR_G	47	C-1 Burst only	Measure the 8.86MHz component output amplitude at pin 47.	
Residual higher harmonic level R	E_CAR_R	48	Burst only	Measure the 8.86MHz component output amplitude at pin 48.	
[Chroma block]: PAL					
ACC amplitude characteristics 1	ACCM1_P	46	C-1 0dB +6dB	Measure the output amplitude when 0dB is applied to the chroma input and when +6dB is applied to the chroma input. And calculate the ratio between them. $ACCM1_P=20 \log (+6dBdata/0dBdata)$	Color:1000000
ACC amplitude characteristics 2	ACCM2_P	46	C-1 -20dB	Measure the output amplitude when -20dB is applied to the chroma input and calculate the ratio between them. $ACCM2_P=20 \log (-20dBdata/0dBdata)$	Color:1000000
Demodulation output ratio R-Y/B-Y:PAL	RB_P	46	C-1	Refer to 5. and measure Bout output amplitude V_b and R_{OUT} output amplitude V_r . And calculate $RB_P=V_r/V_b$.	Color:1000000
		48			
Demodulation output ratio G-Y/B-Y:PAL	GB_P	46	C-4	Measure Bout output amplitude V_{bp} and G_{OUT} output amplitude V_{gpb} . And calculate $GB_P=V_{gpb}/V_{bp}$.	Color:1000000
		47			
Demodulation output ratio G-Y/R-Y:PAL	GR_P	47	C-5	Measure R_{OUT} output amplitude V_{rp} and G_{OUT} output amplitude V_{gpb} . And calculate $GR_P=V_{grp}/V_{rp}$.	Color:1000000
		48			
Demodulation angle R-Y/B-Y:PAL	ANGRB_P	46	C-1	Refer to 5. and measure the B-Y and R-Y demodulation angle and calculate.	Color:1000000
		48			
Killer operating point 0 (PAL)	KILLP0	46	C-1	Reduce the input signal until the output Level becomes 75mVp-p or less. Measure the input level at that moment.	Color Killer Ope.:00
Killer operating point 3 (PAL)	KILLP3	46	C-1	Reduce the input signal until the output Level becomes 75mVp-p or less. Measure the input level at that moment.	Color Killer Ope.:11
Difference between two Killer operating points (PAL)	DKILLP			Calculate as follows, $DKILLP=KILLP0-KILLP3$	
APC pull-in range(+)	PULIN+_P	46	C-1	Decrease the chroma fsc frequency from 4.433619MHz+1000Hz and measure the frequency at which the V_{CO} locks.	
APC pull-in range(-)	PULIN-_P	46	C-1	Increase the chroma fsc frequency from 4.433619MHz-1000Hz and measure the frequency at which the V_{CO} locks.	

LV76213A2C

Parameter	Symbol	Test point	Input signal	Test method	Bus conditions
[Chroma block]: NTSC					
ACC amplitude characteristics 1	ACCM1_N	46	C-1 0dB +6dB	Measure the output amplitude when 0dB is applied to the chroma input and when +6dB is applied to the chroma input. And calculate the ratio between them. $ACCM1_N=20\log(+6dBdata/0dBdata)$	
ACC amplitude characteristics 2	ACCM2_N	46	C-1 -20dB	Measure the output amplitude when 20dB is applied to the chroma input and calculate the ratio between them. $ACCM2_N=20\log(-20dBdata/0dBdata)$	
Demodulation output ratio R-Y/B-Y:NTSC	RB_N	46 48	C-1	Refer to 5. And measure Bout output amplitude Vb and ROUT output amplitude Vr. And calculate $RB_N=Vr/Vb$.	Color:1000000
Demodulation output ratio G-Y/B-Y:NTSC	GB_N	47	C-1	Refer to 5. and measure GOUT output amplitude Vg. And calculate $GB_N=Vg/Vb$.	Color:1000000
Demodulation angle B-Y/R-Y: NTSC	ANGBR_N	46 48	C-1	Refer to 5. and measure the B-Y and R-Y demodulation angle and calculate. Reference: B-Y angle	Color:1000000
Demodulation angle G-Y/B-Y: NTSC	ANGGB_N	46 47	C-1	Refer to 5. and measure the B-Y and G-Y demodulation angle and calculate. Reference: B-Y angle	Color:1000000
Killer operating point 0 (NTSC)	KILLN0	46	C-1	Reduce the input signal until the output Level becomes 75mVp-p or less. Measure the input level at that moment.	Color Killer Ope.:00
Killer operating point 3 (NTSC)	KILLN3	46	C-1	Reduce the input signal until the output Level becomes 75mVp-p or less. Measure the input level at that moment.	Color Killer Ope.:11
Difference between two Killer operating points (NTSC)	DKILLN			Calculate as follows, $DKILLN=KILLN0-KILLN3$	
APC pull-in range(+)	PULIN+_N	46	C-1	Decrease the chroma fsc frequency from 3.579545MHz+1000Hz and measure the frequency at which the V _{CO} locks.	
APC pull-in range(-)	PULIN-_N	46	C-1	Increase the chroma fsc frequency from 3.579545MHz-1000Hz and measure the frequency at which the V _{CO} locks.	
Tint center	TINCEN	46	C-1	Measure each part of the output level and calculate the B-Y axis angle.	TINT:1000000
Tint variable range (+)	TINT+	46	C-1	Measure each part of the output level and calculate the B-Y axis angle. $TINT+=B-Y\ axis\ angle-TINCEN$	TINT:1111111
Tint variable range (-)	TINT-	46	C-1	Measure each part of the output level and calculate the B-Y axis angle. $TINT-=B-Y\ axis\ angle-TINCEN$	TINT:0000000
Cr output Amplitude	CBCR-R	48	R-Y IN:C-6	Measure the output amplitude. (B-Y IN:no signal)	CbCr IN: 1 Color Sys:101 Cross B/W: 01
Cb output Amplitude	CBCR-B	46	B-Y IN:C-6	Measure the output amplitude. (R-Y IN:no signal)	CbCr IN: 1 Color Sys: 101 Cross B/W: 01
[Filter Block]:Chroma BPF Characteristic					
C-BPF1A Peaker amplitude characteristic 3.93MHz	CBPF1A	46	C-3 PAL signal	Set the chroma frequency (CW) to 4.433619MHz-100kHz and measure V ₀ output amplitude. And then, set the chroma frequency (CW) to 3.93MHz and measure V ₁ output amplitude to calculate as follows: $CBPF1A=20\log(V_1/V_0)$	C.Filter.Sys:10 C.BYPASS:0
C-BPF1B Peaker amplitude characteristic 4.73/4.13MHz	CBPF1B	46	C-3 PAL signal	Measure V ₂ output amplitude when the chroma frequency (CW) is 4.13MHz and V ₃ output amplitude when it (CW) is 4.73MHz to calculate as follows: $CBPF1B=20\log(V_3/V_2)$	C.Filter.Sys:10 C.BYPASS:0
C-BPF1C Peaker amplitude characteristic 4.93/3.93MHz	CBPF1C	46	C-3 PAL signal	Set the chroma frequency (CW) to 4.93MHz and measure V ₄ output amplitude to calculate as follows: $CBPF1C=20\log(V_4/V_1)$	C.Filter.Sys:10 C.BYPASS:0
C-BPF2A BandPass amplitude characteristic 3.93MHz	CBPF2A	46	C-3 PAL signal	Set the chroma frequency (CW) to 4.433619MHz-100MHz and measure V ₀₀ output amplitude. And then, set the chroma frequency (CW) to 3.93MHz and measure V ₁₀ output amplitude to calculate as follows: $CBPF2A=20\log(V_{10}/V_{00})$	C.Filter.Sys:11 C.BYPASS:0
C-BPF2B BandPass amplitude characteristic 4.73/4.13MHz	CBPF2B	46	C-3 PAL signal	Measure V ₂₀ output amplitude when the chroma frequency (CW) is 4.13MHz and V ₃₀ output amplitude when it (CW) is 4.73MHz to calculate as follows: $CBPF2B=20\log(V_{30}/V_{20})$	C.Filter.Sys:11 C.BYPASS:0
C-BPF2C BandPass amplitude characteristic 4.93/3.93MHz	CBPF2C	46	C-3 PAL signal	Set the chroma frequency (CW) to 4.93MHz and measure V ₄₀ output amplitude to calculate as follows: $CBPF2C=20\log(V_{40}/V_{10})$	C.Filter.Sys:11 C.BYPASS:0

•Deflection Block Input Signals and Test Conditions

Unless otherwise specified, the following conditions apply when each measurement is made.

1. VIF, SIF blocks: No signal
2. C input: No. signal
3. Sync input: A horizontal/vertical composite sync signal

PAL: 43IRE, horizontal sync signal (15.625kHz) and vertical sync signal (50kHz)
 NTSC: 40IRE, horizontal sync signal (15.734264kHz) and vertical sync signal (59.94kHz)

Note: No burst signal, chroma signal shall exist below the pedestal level.

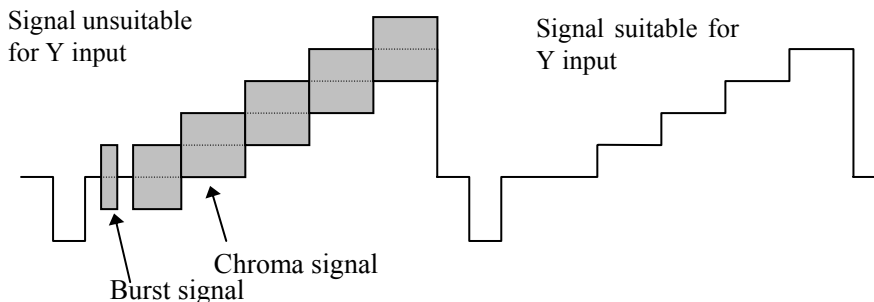

4. Bus control conditions: Initial conditions unless otherwise specified.
5. The delay time from the rise of the horizontal output (pin 22 output) to the fall of the FBP IN (pin 23 input) is 7µs.
6. Pin 15 (vertical size correction circuit input terminal) is connected to V_{CC} (5.0V).

Parameter	Symbol	Test point	Input signal	Test method	Bus conditions
[Deflection block]					
Horizontal free-running frequency	fH	22	YIN: No signal	Connect a frequency counter to the output of pin 22 (H out) and measure the horizontal free-running frequency.	
Horizontal pull-in range	fH PULL	22 5	YIN: Horizontal /vertical sync signal PAL	Using an oscilloscope, monitor the horizontal sync signal which is input to the Y IN (pin 5) and the pin 22 output (H out) and vary the horizontal signal frequency to measure the pull-in range.	
Horizontal output pulse length	Hduty	22	YIN: Horizontal /vertical sync signal PAL	Measure the voltage for the pin 22 horizontal output pulse's low-level period.	
Horizontal output pulse saturation voltage	VHsat	22	YIN: Horizontal /vertical sync signal PAL	Measure the voltage for the pin 22 horizontal output pulse's low-level period.	
Vertical free-running period 50(PAL) Vertical free-running period 60(NTSC)	VFR50 VFR60	17	YIN: No signal	Measure the vertical output period T at pin 17. T × 15.625kHz (PAL) T × 15.734kHz (NTSC)	CDMODE:001 (PAL) CDMODE:010 (NTSC)
Horizontal output pulse (PAL)(NTSC)	HPHCEN (PAL) (NTSC)	22 5	YIN: Horizontal /vertical sync signal PAL NTSC	Measure the delay time from to the rise of the pin 22 horizontal output pulse to the fall of the Y IN horizontal sync signal.	

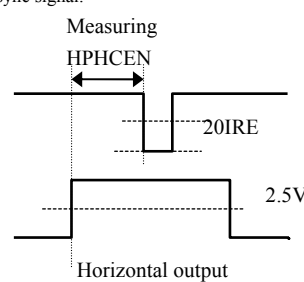
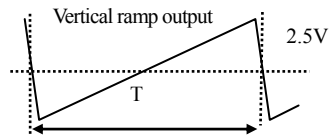

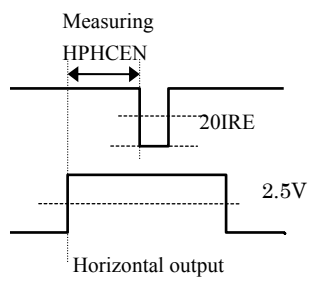
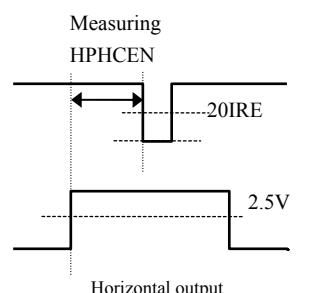
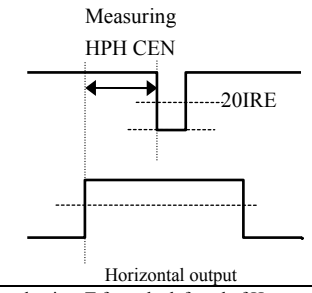
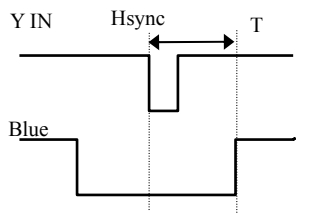
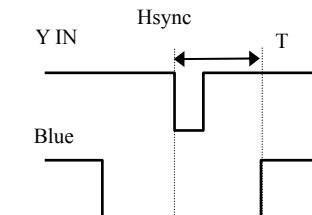
Parameter	Symbol	Test point	Input signal	Test method	Bus conditions
Horizontal position adjustment range	HPHrange	22 5	Y IN: Horizontal /vertical sync signal PAL	With H.PHASE: 0 and 31, measure the delay time from the rise of the pin 22 horizontal output pulse to the fall of the Y IN horizontal sync signal and calculate the difference from H PHCEN. 	H.PHASE:00000 to H.PHASE:11111
Horizontal position adjustment maximum variable width	HPHstep	22 5	Y IN: Horizontal /vertical sync signal PAL	With H.PHASE: 0 to 31 varied, measure the delay time from to the rise of the pin 22 horizontal output pulse to the fall of the Y IN horizontal sync signal and calculate the variation at each step. Retrieve data for maximum variation. 	H.PHASE:00000 to H.PHASE:11111
Horizontal position adjustment maximum variable width	HPHstep	22 5	Y IN: Horizontal /vertical sync signal PAL	With H.PHASE: 0 to 31 varied, measure the delay time from to the rise of the pin 22 horizontal output pulse to the fall of the Y IN horizontal sync signal and calculate the variation at each step. Retrieve data for maximum variation. 	H.PHASE:00000 to H.PHASE:11111
Horizontal blanking left variable range@0	BLKL0	46 5	Y IN: Horizontal /vertical sync signal PAL	Measure the time T from the left end of Hsync at pin 5 Y IN to the right end of blanking period at pin 46 BlueOUT with H.BLK.L = 000. 	H.BLK.L:000
Horizontal blanking left variable range@7	BLKL7	46 5	Y IN: Horizontal /vertical sync signal PAL	Measure the time T from the left end of Hsync at pin 5 Y IN to the right end of blanking period at pin 46 BlueOUT with H.BLK.L = 111. 	H.BLK.L:111

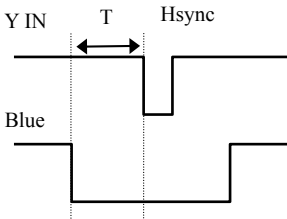
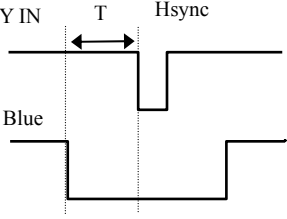
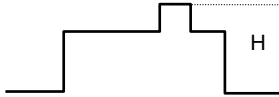
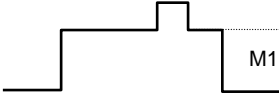
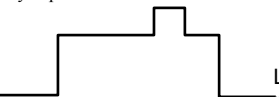
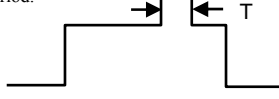
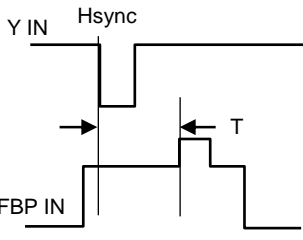
Parameter	Symbol	Test point	Input signal	Test method	Bus conditions
Horizontal blanking right variable range@0	BLKR0	46 5	Y IN: Horizontal /vertical sync signal PAL	Measure the time T from the left end of Hsync at pin 5 Y IN to the left end of blanking period at pin 46 BlueOUT with H.BLK.R = 000. 	H.BLK.R:000
Horizontal blanking right variable range@7	BLKR7	46 5	Y IN: Horizontal /vertical sync signal PAL	Measure the time T from the left end of Hsync at pin 5 Y IN to the left end of blanking period at pin 46 BlueOUT with H.BLK.R = 111. 	H.BLK.R:111
Sand castle pulse crest value H	SANDH	23	Y IN: Horizontal /vertical sync signal PAL	Measure the supply voltage at point H of the pin 23 FBP IN wave form for Hsync period. 	
Sand castle pulse crest value M1	SANDM1	23	Y IN: Horizontal /vertical sync signal PAL	Measure the supply voltage at point M1 of the pin 23 FBP IN wave form for Hsync period. 	
Sand castle pulse crest value L	SANDL	23	Y IN: Horizontal /vertical sync signal PAL	Measure the supply voltage at point L of the pin 23 FBP IN wave form for Hsync period. 	
Burst gate pulse length	BGPWD	23	Y IN: Horizontal /vertical sync signal PAL	Measure the BGP width T of the pin 23 FBP IN wave form for Hsync period. 	
Burst gate pulse phase	BGPPH	23 5	Y IN: Horizontal /vertical sync signal PAL	Measure the time from the left end of Hsync at pin 5 Y IN to the left end of the pin 23 FBP IN wave form for Hsync period. 	
Horizontal output stop voltage	Hstop	20 22	Y IN: Horizontal /vertical sync signal	Decrease the current from a source connected to pin 20 and measure the pin 20 voltage at which HOUT(PIN22) stops.	

LV76213A2C

Parameter	Symbol	Test point	Input signal	Test method	Bus conditions
H Phase BOW@16	HBOW16	22 5	Y IN: Horizontal /vertical sync signal	<p>Measure the delay time T from the rise of the pin 22 horizontal output pulse to the fall of the Y IN horizontal sync signal with line 24(NTSC:22) and 167(NTSC:142). Caluculat as follow with each value of T is as T1 and T2. HBOW16=T2-T1</p> <p>The diagram shows two waveforms. The top waveform is the Y IN signal, which has a horizontal sync pulse. The bottom waveform is the Horizontal Out signal, which has a horizontal output pulse. A double-headed arrow labeled 'T' indicates the time delay from the rising edge of the Horizontal Out pulse to the falling edge of the Y IN sync signal. The Y IN signal is labeled '20IRE' and the Horizontal Out signal is labeled '2.5V'.</p>	
H Phase BOW@0	HBOW0	22 5	Y IN: Horizontal /vertical sync signal	<p>Measure the delay time T from the rise of the pin 22 horizontal output pulse to the fall of the Y IN horizontal sync signal with line 24(NTSC:22) and 167(NTSC:142). Caluculat as follow with each value of T is as T1 and T2. HBOW0=T2-T1</p> <p>The diagram shows two waveforms. The top waveform is the Y IN signal, which has a horizontal sync pulse. The bottom waveform is the Horizontal Out signal, which has a horizontal output pulse. A double-headed arrow labeled 'T' indicates the time delay from the rising edge of the Horizontal Out pulse to the falling edge of the Y IN sync signal. The Y IN signal is labeled '20IRE' and the Horizontal Out signal is labeled '2.5V'.</p>	H Phase Bow: 00000
H Phase BOW@31	HBOW31	22 5	Y IN: Horizontal /vertical sync signal	<p>Measure the delay time T from the rise of the pin 22 horizontal output pulse to the fall of the Y IN horizontal sync signal with line 24(NTSC:22) and 167(NTSC:142). Caluculat as follow with each value of T is as T1 and T2. HBOW31=T2-T1</p> <p>The diagram shows two waveforms. The top waveform is the Y IN signal, which has a horizontal sync pulse. The bottom waveform is the Horizontal Out signal, which has a horizontal output pulse. A double-headed arrow labeled 'T' indicates the time delay from the rising edge of the Horizontal Out pulse to the falling edge of the Y IN sync signal. The Y IN signal is labeled '20IRE' and the Horizontal Out signal is labeled '2.5V'.</p>	H Phase Bow: 11111
H Phase ANGLE@16	HANG16	22 5	Y IN: Horizontal /vertical sync signal	<p>Measure the delay time T from the rise of the pin 22 horizontal output pulse to the fall of the Y IN horizontal sync signal with line 24(NTSC:22) and 167(NTSC:142).Caluculat as follow with each value of T is as T1 and T2. HANG16=T2-T1</p> <p>The diagram shows two waveforms. The top waveform is the Y IN signal, which has a horizontal sync pulse. The bottom waveform is the Horizontal Out signal, which has a horizontal output pulse. A double-headed arrow labeled 'T' indicates the time delay from the rising edge of the Horizontal Out pulse to the falling edge of the Y IN sync signal. The Y IN signal is labeled '20IRE' and the Horizontal Out signal is labeled '2.5V'.</p>	
H Phase ANGLE@0	HANG0	22 5	Y IN: Horizontal /vertical sync signal	<p>Measure the delay time T from the rise of the pin 22 horizontal output pulse to the fall of the Y IN horizontal sync signal with line 24(NTSC:22) and 167(NTSC:142).Caluculat as follow with each value of T is as T1 and T2. HANG0=T2-T1</p> <p>The diagram shows two waveforms. The top waveform is the Y IN signal, which has a horizontal sync pulse. The bottom waveform is the Horizontal Out signal, which has a horizontal output pulse. A double-headed arrow labeled 'T' indicates the time delay from the rising edge of the Horizontal Out pulse to the falling edge of the Y IN sync signal. The Y IN signal is labeled '20IRE' and the Horizontal Out signal is labeled '2.5V'.</p>	H Phase Angle: 00000

LV76213A2C

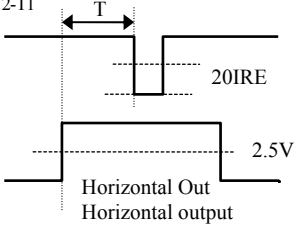
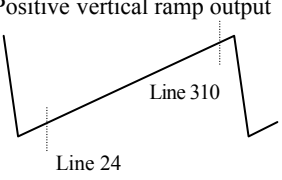
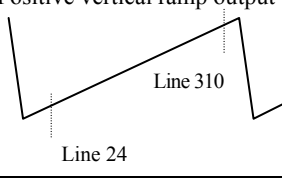
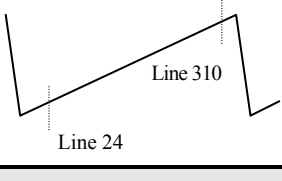
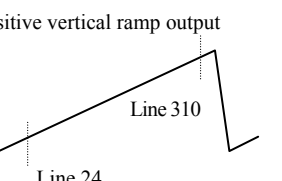
Parameter	Symbol	Test point	Input signal	Test method	Bus conditions
H Phase ANGLE@31	HANG31	22 5	Y IN: Horizontal /vertical sync signal	Measure the delay time T from the rise of the pin 22 horizontal output pulse to the fall of the Y IN horizontal sync signal with line 24(NTSC:22) and 167(NTSC:142). Calculat as follow with each value of T is as T1 and T2. HANG31=T2-T1 	H Phase Angle: 111111
<Vertical screen size correction>					
vertical ramp output amplitude @64	Vsize64	17	Y IN: Horizontal /vertical sync signal PAL NTSC	Monitor the pin 17 vertical ramp output and measure the voltage at line 24 (22:NTSC) and line 310 (262:NTSC). Calculate as follows: $Vsize64 = Vline310(262:NTSC) - Vline24(22:NTSC)$ 	
vertical ramp output amplitude @0	Vsize0	17	Y IN: Horizontal /vertical sync signal PAL NTSC	Monitor the pin 17 vertical ramp output and measure the voltage at line 24 (22:NTSC) and line 310 (262:NTSC). Calculate as follows: $Vsize0 = Vline310(262:NTSC) - Vline24(22:NTSC)$ 	VSIZE: 0000000
vertical ramp output amplitude @127	Vsize127	17	Y IN: Horizontal /vertical sync signal PAL NTSC	Monitor the pin 17 vertical ramp output and measure the voltage at line 24 (22:NTSC) and line 310 (262:NTSC). Calculate as follows: $Vsize127 = Vline310(262:NTSC) - Vline24(22:NTSC)$ 	VSIZE: 1111111
<High-voltage dependent vertical size correction>					
Vertical size correction @0	Vsizecomp	17	Y IN: Horizontal /vertical sync signal PAL	Monitor the pin 17 vertical ramp output and measure the voltage at the line 24 and line 310 with VCOMP = 000. Calculate as follows: $Va = Vline310 - Vline24$ Apply 4.0V to pin 15 and measure the voltage at the line 24 and line 310 again. Calculate as follows: $Va = Vline310 - Vline24$ Calculate as follows: $Vsizecomp = Vb/Va$ 	VCOMP:000 FSCorEHT=1

LV76213A2C

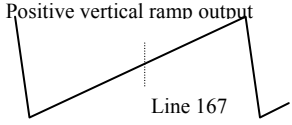
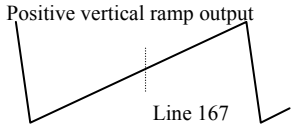
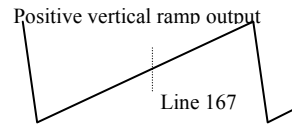
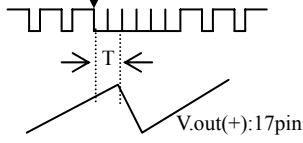
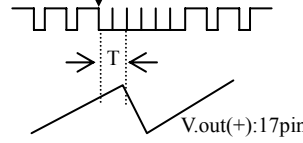
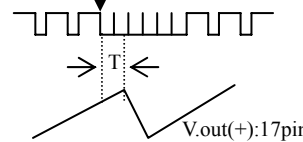
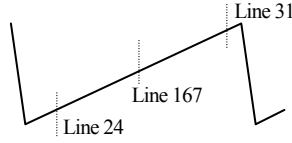
Parameter	Symbol	Test point	Input signal	Test method	Bus conditions
<Vertical screen position adjustment>					
Vertical ramp DC voltage @32	Vdc32	17	Y IN: Horizontal /vertical sync signal PAL NTSC	Monitor the pin 17 vertical ramp output and measure the voltage at line 167(142: NTSC). Positive vertical ramp output 	
Vertical ramp DC voltage @0	Vdc0	17	Y IN: Horizontal /vertical sync signal PAL NTSC	Monitor the pin 17 vertical ramp output and measure the voltage at line 167(142: NTSC). Positive vertical ramp output 	VDC:000000
Vertical ramp DC voltage @63	Vdc63	17	Y IN: Horizontal /vertical sync signal PAL NTSC	Monitor the pin 17 vertical ramp output and measure the voltage at line 167(142: NTSC). Positive vertical ramp output 	VDC:111111
Verticalposition @8	Vshift8	17 5	Y IN: Horizontal /vertical sync signal	Measure the time T from the beginning of Vsync at pin 5 Y IN to the fall of the pin 17. the beginning of Vsync 	VSHIFT:1000
Vertical position @0	Vshift0	17 5	Y IN: Horizontal /vertical sync signal	Measure the time T from the beginning of Vsync at pin 5 Y IN to the fall of the pin 17. the beginning of Vsync 	VSHIFT:0000
Vertical position @15	Vshift15	17 5	Y IN: Horizontal /vertical sync signal	Measure the time T from the beginning of Vsync at pin 5 Y IN to the Rise of the pin 17. the beginning of Vsync 	VSHIFT:1111
Vertical linearity@16	Vlin16	17	Y IN: Horizontal /vertical sync signal PAL	Monitor the pin 17 vertical ramp output and measure the voltage at line 24, line 167 and 310. Assign the respective measured values to Va, Vb and Vc. Calculate as follows: $Vlin16=(Vb-Va)/(Vc-Vb)$ Positive vertical ramp output 	

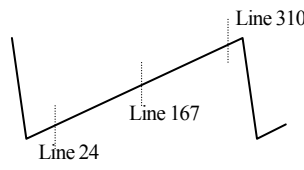
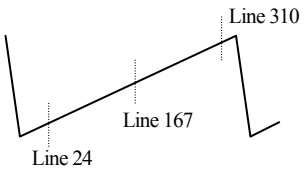
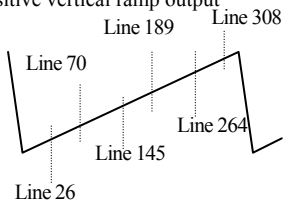
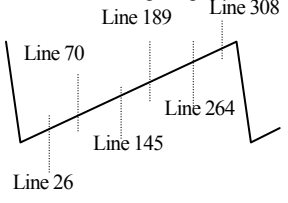
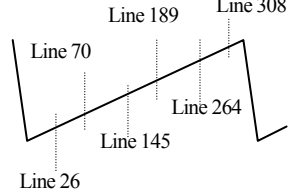
Parameter	Symbol	Test point	Input signal	Test method	Bus conditions
Vertical linearity@0	Vlin0	17	Y IN: Horizontal /vertical sync signal PAL	Monitor the pin 17 vertical ramp output and measure the voltage at line 24, line 167 and 310. Assign the respective measured values to Va, Vb and Vc. Calculate as follows: $Vlin0=(Vb-Va)/(Vc-Vb)$ Positive vertical ramp output 	VLIN:00000
Vertical linearity@31	Vlin31	17	Y IN: Horizontal /vertical sync signal PAL	Monitor the pin 17 vertical ramp output and measure the voltage at line 24, line 167 and 310. Assign the respective measured values to Va, Vb and Vc. Calculate as follows: $Vlin31=(Vb-Va)/(Vc-Vb)$ Positive vertical ramp output 	VLIN:11111
Vertical S-shaped correction @16	Vscor16	17	Y IN: Horizontal /vertical sync signal PAL	Monitor the pin 17 vertical ramp output and measure the voltage at line 26, line 70, line 145, line 189, line 264 and 308. Assign the respective measured values to Va, Vb, Vc, Vd, Ve and Vf. Calculate as follows: $Vscor16=0.5((Vb-Va)+(Vf-Ve))/(Vd-Vc)$ Positive vertical ramp output 	
Vertical S-shaped correction @0	Vscor0	17	Y IN: Horizontal /vertical sync signal PAL	Monitor the pin 17 vertical ramp output and measure the voltage at line 26, line 70, line 145, line 189, line 264 and 308. Assign the respective measured values to Va, Vb, Vc, Vd, Ve and Vf. Calculate as follows: $Vscor0=0.5((Vb-Va)+(Vf-Ve))/(Vd-Vc)$ Positive vertical ramp output 	VSC:10000
Vertical S-shaped correction @31	Vscor31	17	Y IN: Horizontal /vertical sync signal PAL	Monitor the pin 17 vertical ramp output and measure the voltage at line 26, line 70, line 145, line 189, line 284 and 308. Assign the respective measured values to Va, Vb, Vc, Vd, Ve and Vf. Calculate as follows: $Vscor31=0.5((Vb-Va)+(Vf-Ve))/(Vd-Vc)$ Positive vertical ramp output 	VSC:11111

LV76213A2C

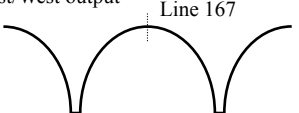
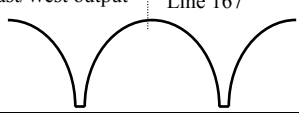
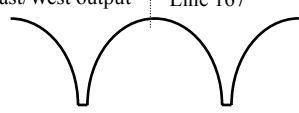
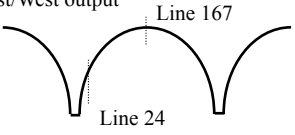
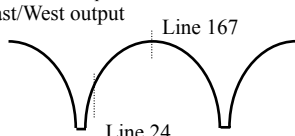
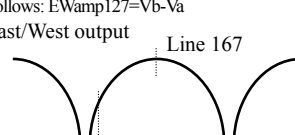
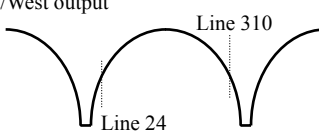
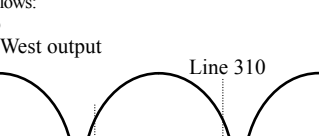
Parameter	Symbol	Test point	Input signal	Test method	Bus conditions
<Horizontal size adjustment>					
East/Wst DC oltage @64	EWdc64	16	Horizontal, vertical sync signal	Monitor the East/West output (parabolic wave output) of pin 16 and measure the voltage at line 167. East/West output 	
East/West DC voltage @0	EWdc0	16	Horizontal, vertical sync signal	Monitor the East/West output (parabolic wave output) of pin 16 and measure the voltage at line 167. East/West output 	EWDC:000000
East/West DC voltage @127	EWdc127	16	Horizontal, vertical sync signal	Monitor the East/West output (parabolic wave output) of pin 16 and measure the voltage at line 167. East/West output 	EWDC:111111
<High-voltage dependent horizontal size compensation>					
Horizontal size compensation @0	Hsizecomp	16	Horizontal, vertical sync signal	Monitor the West/East output of pin 16 and measure the voltage (Va) at line 167. Apply 4.0 V to pin 16 and measure again the voltage (Vb) at line 167. Calculate as follows: $Hsizecomp=Va-Vb$	HCOMP:000 FSCorEHT=1
<Pincushion distortion compensation>					
East/West parabolic amplitude @64	EWamp64	16	Horizontal, vertical sync signal	Monitor the East/West output (parabolic wave output) of pin 16 and measure the voltage at line 24 (Va) and line 167 (Vb). Calculate as follows: $EWamp64=Vb-Va$ East/West output 	EWDC :111111
East/West parabolic amplitude @0	EWamp0	16	Horizontal, vertical sync signal	Monitor the East/West output (parabolic wave output) of pin 16 and measure the voltage at line 24 (Va) and line 167 (Vb). Calculate as follows: $EWamp0=Vb-Va$ East/West output 	EWAMP:000000 EWDC : 111111
East/West parabolic amplitude @127	EWamp127	16	Horizontal, vertical sync signal	Monitor the East/West output (parabolic wave output) of pin 16 and measure the voltage at line 24 (Va) and line 167 (Vb). Calculate as follows: $EWamp127=Vb-Va$ East/West output 	EWAMP:111111 EWDC : 111111
<Trapezoidal distortion compensation>					
East/West parabolic tilt @64	EWtilt64	16	Horizontal, vertical sync signal	Monitor the East/West output (parabolic wave output) of pin 16 and measure the voltage at line 24 (Va) and line 310 (Vb). Calculate as follows: $Ewtilt64=Va-Vb$ East/West output 	EWDC : 111111 EWCORSW: 1
East/West parabolic tilt @0	EWtilt0	16	Horizontal, vertical sync signal	Monitor the East/West output (parabolic wave output) of pin 16 and measure the voltage at line 24 (Va) and line 310 (Vb). Calculate as follows: $Ewtilt0=Va-Vb$ East/West output 	EWTILT:000000 EWDC : 111111 EWCORSW : 1

LV76213A2C

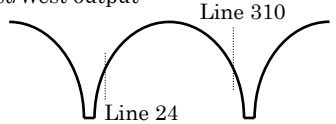
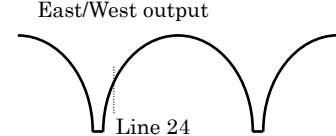
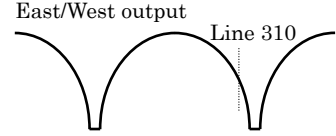
Parameter	Symbol	Test point	Input signal	Test method	Bus conditions
East/West parabolic tilt @127	EWtilt127	16	Horizontal, vertical sync signal	Monitor the East/West output (parabolic wave output) of pin 16 and measure the voltage at line 24 (Va) and line 310 (Vb). Calculate as follows: $EWtilt127 = Va - Vb$ East/West output 	EW/TILT:1111111 EWDC : 1111111 EWCORSW : 1
<Corner distortion compensation>					
East/West parabolic corner TOP	EWcortop	16	Horizontal, vertical sync signal	Monitor the East/West output (parabolic wave output) of pin 16 and measure the voltage at line 24 under conditions of CORTOP:11111 (Va) and CORTOP:00000 (Vb). Calculate as follows: $EWcortop = Va - Vb$ East/West output 	CORTOP: 11111-00000 EWDC : 1111111 EWCORSW : 1
East/West parabolic corner BOTTOM	EWcorbot	16	Horizontal, vertical sync signal	Monitor the East/West output (parabolic wave output) of pin 16 and measure the voltage at line 310 under conditions of CORBOT:11111 (Va) and CORBOT:00000 (Vb). Calculate as follows: $EWcorbot = Va - Vb$ East/West output 	CORBOTTOM: 11111-00000 EWDC : 1111111 EWCORSW : 1

μ-Controller Chip (LC873264A)

Internal 64K-byte FROM (ROM/CGROM), 640-byte RAM And 352×9-bit CRT Display RAM 8-bit Single-chip Microcontroller.

1. Features

■ROM

64K bytes

- 48K-byte program ROM
- 16K-byte character generator ROM

■Internal RAM

- General-purpose RAM: 640 bytes
- CRT display RAM: 352 × 9 bits
- ROM correction RAM: 128 bytes

■Minimum bus cycle time

- 77 ns (13.0 MHz)

Note: The bus cycle time here refers to the ROM read speed.

■Minimum instruction cycle time

- 231 ns (13.0MHz)

■OSD

- Screen display: 36 characters × 8 lines
- Display RAM : 352 words (1 word=9 bits)
Display area: 36 words × 8 lines
Control area: 8 words × 8 lines
- Font types: 16×32 font, 256 types (including 5 fixed fonts)
An arbitrary number of characters can be generated as 16×17 or 8×9 font characters.
- Display colors: 512 colors (Analog output)
Character text, background, borders, and full background can be displayed.

A maximum 16 colors displayable on a line.

- Display mode specifiable on a line basis.
OSD mode1, OSD mode 2(Quarter size), OSD mode 3(Simplified graphic), caption/text mode
 - Vertical display start line and horizontal display start position specifiable on a line basis.
 - Shutter function (specifying the display start or stop line) and scroll functions specifiable on a line basis.
 - Horizontal character spacing (9 to 16 dots) (*6) and vertical character spacing (1 to 32 dots) specifiable on a line basis.
 - Character size selectable from 10 character sizes on a line basis. (*6)
(Horizontal×Vertical) = (1×1), (1×2), (2×2), (2×4), (1.5×1), (1.5×2), (3×2), (3×4), (0.5×0.5), (0.75×0.5)
 - Simplified graphic display (One character (16×16 font) can be painted in 4 or 8 colors.)
 - The half tone control of the TV picture in the background of the character is possible.
 - Built-in the oscillation circuit for display
- (*6)The supported range varies depending on the active display mode. Refer to the user's guide for details.

■Data slicer function(closed caption format)

- Extracts closed caption data and XDS data.
- NTSC/PAL selectable and line specifiable.

■Ports

- Normal withstand voltage I/O ports

Ports whose I/O direction can be designated in 1 bit units: 10 (P1n, P3n)

Ports whose I/O direction can be designated in 4 bit units: 8 (P0n)

*If X'tal oscillator is to be used for time-of-day clock, the number of available Port 0 is 6.

Note: Three of the available ports are internally connected to the companion signal processing IC.

■Timers

- Timer 0: 16-bit timer/counter with a capture register.
- Timer 1: 16-bit timer/counter that supports PWM/toggle outputs
- Base timer

■SIO

- SIO0: 8-bit synchronous serial interface
 - SIO1: 8-bit asynchronous/synchronous serial interface (bus mode 1 system)
- Input and output is possible from the terminal of two systems in bus mode.
The two data lines and clock lines can be connected.

■AD converter: 6 bits ×5 channels

Note: One channel is connected internally to the signal processing IC.

■PWM: 14-bit PWM×1 channel

■Remote controller receiver circuit (sharing with P03 and INT3 pins)

- Noise rejection function (noise filter time constant selectable from 1 Tcyc,32 Tcyc,and 128Tcyc)

■Watchdog timer

- External RC watchdog timer
- Interrupt and reset signals selectable

■High-speed multiplication/division instructions

- 16 bits×8 bits (Execution time: 5 Tcyc)
- 24 bits×16 bits (Execution time: 12 Tcyc)
- 16 bits÷8 bits (Execution time: 8 Tcyc)
- 24 bits÷16 bits (Execution time: 12 Tcyc)

■Interrupts

- 15 sources, 10 vector addresses

- 1) Provides three levels (low (L), high (H), and highest (X)) of multiplex interrupt control. Any interrupt requests of the level equal to or lower than the current interrupt are not accepted.
- 2) When interrupt requests to two or more vector addresses occur at the same time, the interrupt of the highest level takes precedence over the other interrupts. For interrupts of the same level, the interrupt into the smallest vector address takes precedence.

No.	Vector Address	Level	Interrupt Source
1	00003H	X or L	INT0
2	0000BH	X or L	INT1
3	00013H	H or L	INT2/T0L
4	0001BH	H or L	INT3/base timer
5	00023H	H or L	T0H
6	0002BH	H or L	T1L/T1H
7	00033H	H or L	SIO0
8	0003BH	H or L	SIO1/data slicer
9	00043H	H or L	vertical sync (VS#)/scan line
10	0004BH	H or L	Port 0

- Priority levels X > H > L
- If interrupts of the same level, the one with the smallest vector address takes precedence.

■Subroutine stack levels: 1024 levels maximum (the stack is allocated in RAM.)

■Oscillation circuits

- RC oscillation circuit (internal): For system clock
- VCO oscillation circuit (internal): For system clock generation and CRT display
- Crystal oscillation circuit: For base timer

Note: When the base timer count of clock accuracy is necessary, use the port terminal (two ports) as the crystal oscillation. (See the [12 μ-Controller Chip Crystal Oscillation Circuit and Sample Characteristics] for details.)

■Standby function

- HALT mode: Halts instruction execution while allowing the peripheral circuits to continue operation.
 - 1) Oscillation is not halted automatically.
 - 2) There are three ways of resetting HALT mode.
 - (1) Setting the reset pin to lower level.
 - (2) Generation of reset with the watchdog timer.
 - (3) Setting at least one of the INT0 and INT1 pins to the specified level.
- HOLD mode: Suspends instruction execution and the operation of the peripheral circuits.
 - 1) The VCO and RC oscillators automatically stop operation.
 - 2) There are four ways of resetting the HOLD mode.
 - (1) Setting the reset pin to the lower level.
 - (2) Generation of reset with the watchdog timer.
 - (3) Setting at least one of the INT0 and INT1 pins to the specified level.
 - (4) Having an interrupt source established at port 0.

■ROM correction function

- Executes the correction program on detection of a match with the program counter value.
- Correction program area size: 128 bytes (4 vector addresses)

■Development tools

- Emulator: TCB87 (Type B) (onchip debugger interface board)
 - + ECB873200A (evaluation chip board + LC873200EVA)
 - + POD36-JCT (connector between evaluation chip board and POD)
 - + POD76200 (POD)

2. μ -Controller Chip System Block Diagram

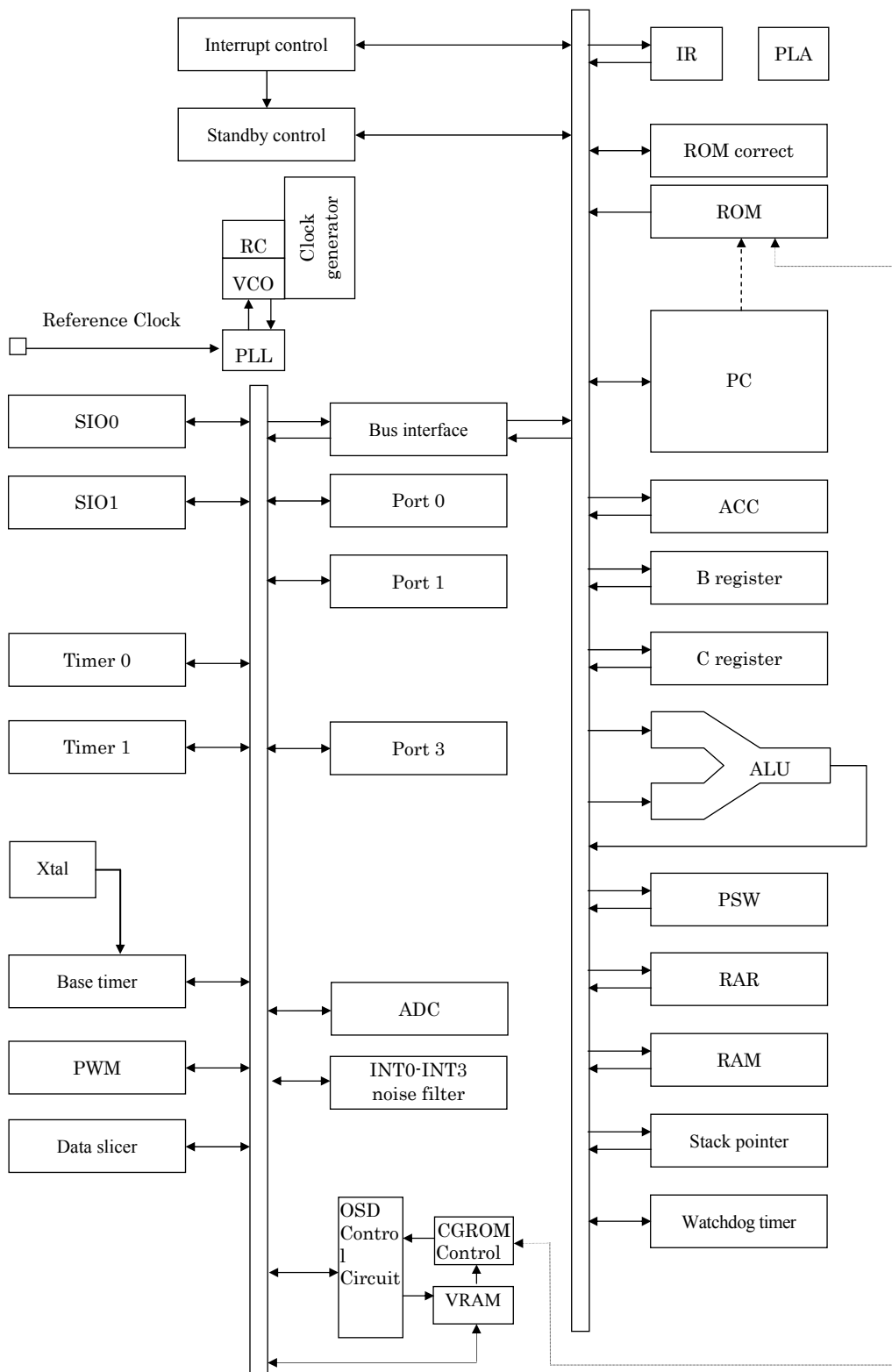

3. μ -Controller Chip Pin Function Chart

Pin Name	I/O	Description	Option																								
CpuGND	-	- power supply pin	No																								
CpuVDD	-	+ power supply pin	No																								
CpuVDD ²	-	+ power supply pin	No																								
Port 0 P00 to P07	I/O	<ul style="list-style-type: none"> • 8-bit I/O port • I/O specifiable in 4 bit units • Pull-up resistors can be turned on and off in 4 bit units. • HOLD reset input • Port 0 interrupt input • Pin functions <ul style="list-style-type: none"> P00: INT0 input/HOLD reset input/timer 0L capture input/watchdog timer output/ SIO0 data output P01: INT1 input/HOLD reset input/timer 0H capture input/SIO0 data input/bus I/O P02: SIO0 clock I/O P03: INT3 input (with noise filter input)/timer 0 event input/ timer 0H capture input P04: AD conversion input terminal (AN4) P05: AD conversion input terminal (AN5) P06: AD conversion input terminal (AN6)/Output terminal for 32.768kHz crystal oscillation (XT2) P07: AD conversion input terminal (AN7)/Input terminal for 32.768kHz crystal oscillation (XT1) <p>Interrupt acknowledge type</p> <table border="1"> <thead> <tr> <th></th> <th>Rising</th> <th>Falling</th> <th>Rising & Falling</th> <th>H Level</th> <th>L Level</th> </tr> </thead> <tbody> <tr> <td>INT0</td> <td>○</td> <td>○</td> <td>×</td> <td>○</td> <td>○</td> </tr> <tr> <td>INT1</td> <td>○</td> <td>○</td> <td>×</td> <td>○</td> <td>○</td> </tr> <tr> <td>INT3</td> <td>○</td> <td>○</td> <td>○</td> <td>×</td> <td>×</td> </tr> </tbody> </table> <p>The two terminal of P00, P01, P04 and P05 can be used as LED driver.</p>		Rising	Falling	Rising & Falling	H Level	L Level	INT0	○	○	×	○	○	INT1	○	○	×	○	○	INT3	○	○	○	×	×	P00-P03: No P04-P07: Yes
	Rising	Falling	Rising & Falling	H Level	L Level																						
INT0	○	○	×	○	○																						
INT1	○	○	×	○	○																						
INT3	○	○	○	×	×																						
Port 1 P11 to P17	I/O	<ul style="list-style-type: none"> • 7-bit I/O port • I/O specifiable in 1 bit units • Pull-up resistors can be turned on and off in 1 bit units. • Pin functions <ul style="list-style-type: none"> P13: TVPWMD output P14: SIO1 data input/bus I/O P15: SIO1 clock I/O P16: SIO1 data input / bus I/O / data output P17: SIO1 clock I/O / T1PWML output 	Yes																								
Port 3 P30 to P32	I/O	<ul style="list-style-type: none"> • 3-bit I/O port (Internal connected terminal) • I/O specifiable in 1 bit units • Pin functions <ul style="list-style-type: none"> P32 : INT2 input / timer 0 event input/ timer 0L capture input <p>Interrupt acknowledge type</p> <table border="1"> <thead> <tr> <th></th> <th>Rising</th> <th>Falling</th> <th>Rising & Falling</th> <th>H Level</th> <th>L Level</th> </tr> </thead> <tbody> <tr> <td>INT2</td> <td>○</td> <td>○</td> <td>○</td> <td>×</td> <td>×</td> </tr> </tbody> </table> <p>Internal communication interface terminal: P30, P31</p>		Rising	Falling	Rising & Falling	H Level	L Level	INT2	○	○	○	×	×	No												
	Rising	Falling	Rising & Falling	H Level	L Level																						
INT2	○	○	○	×	×																						
RES#	Input	Reset pin	No																								
FILT	Output	Internal PLL filter pin for system clock	No																								
VDD ⁱ¹	-	+ power supply pin (Internal connected terminal)	No																								
VDD ⁱ²	-	+ power supply pin (Internal connected terminal)	No																								
RES ⁱ #	Input	Reset pin (Internal connected terminal)	No																								
XTIN	Input	Reference clock input (Internal connected terminal)	No																								
XTSEL	Input	Reference clock frequency selection (Internal connected terminal)	No																								
CVIN	Input	Video input pin (Internal connected terminal)	No																								
PEOUT	Output	Pedestal level output (Internal connected terminal)	No																								
AN3	Input	ADC input terminal (Internal connected terminal)	No																								
VS#	Input	Vertical sync input pin (Internal connected terminal)	No																								
HS#	Input	Horizontal sync input pin (Internal connected terminal)	No																								
R	Output	Red (R) RGB video output pin (Internal connected terminal)	No																								
G	Output	Green (G) RGB video output pin (Internal connected terminal)	No																								
B	Output	Blue (B) RGB video output pin (Internal connected terminal)	No																								
BL1	Output	Fast blanking 1 control output pin (Internal connected terminal)	No																								
BL2	Output	Fast blanking 2 control output pin (Internal connected terminal)	No																								

4. μ -Controller Chip Port Output Types

The table below lists the types of port outputs and the presence/absence of a pull-up resistor.

Data can be read into any input port even if it is in the output mode.

Port name	Option selected in units of	Option type	Output type	Pull-up resistor
P00 to P03	-	No	Nch-open drain	No
P04 to P07	1 bit	1	CMOS	Programmable (*9)
		2	Nch-open drain	No
P11 to P17	1 bit	1	CMOS	Programmable
		2	Nch-open drain	Programmable
P30 to P31	-	No	Nch-open drain	Yes
P32	-	No	Nch-open drain	No

(*9) Programmable pull-up resistors for port 0 are controlled in 4 bit units (P04 to P07).

*Connect the IC as shown below to minimize the noise input to the CpuV_{DD} pin.

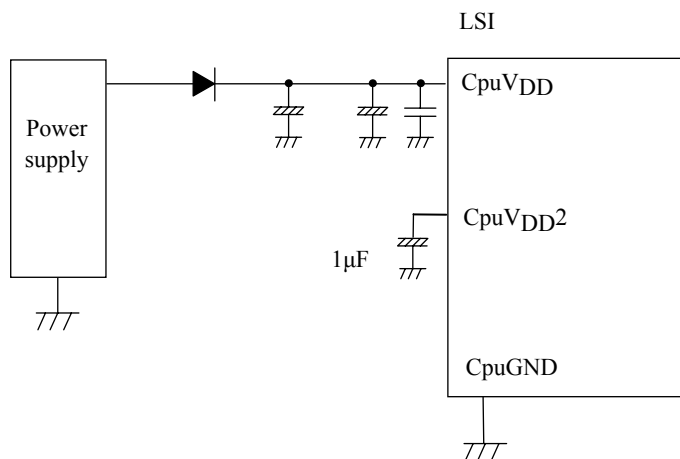

5. μ -Controller Chip Electrical characteristics / $T_a = -10\text{deg}$ to $+65\text{deg}$, $V_{SS} = 0V$

Parameter	Symbol	Pins	Conditions	$V_{DD}[V]$	Limits			
					min	typ	max	unit
High level input current	I _{IH} (1)	Ports0,1	• Output disable • Pull-up MOS Tr.OFF • $V_{IN} = V_{DD}$ (including the off-leak current of the output Tr.)	4.5~5.5			1	μA
	I _{IH} (2)	RES#	$V_{IN} = V_{DD}$	4.5~5.5			1	
Low level input current	I _{IL} (1)	Ports0,1	• Output disable • Pull-up MOS Tr.OFF • $V_{IN} = V_{SS}$ (including the off-leak current of the output Tr.)	4.5~5.5	-1			
	I _{IL} (2)	RES#	$V_{IN} = V_{SS}$	4.5~5.5	-1			
High level output voltage	V_{OH}	Ports04-07, Ports1	$I_{OH} = -1.0mA$	4.5~5.5	$V_{DD} - 1$			V
Low level output voltage	V_{OL} (1)	Ports02,03 Ports06,07 Ports1	$I_{OL} = 10mA$	4.5~5.5			1.5	
			$I_{OL} = 1.6mA$	4.5~5.5			0.4	
	V_{OL} (2)	Ports00,01, Ports04,05	$I_{OL} = 8.0mA$	4.5~5.5			0.4	
Pull-up MOS Tr. Resistance	R _{pu}	Ports04-07,1	$V_{OH} = 0.9V_{DD}$	4.5~5.5	15	40	70	k Ω
Bus terminal short circuit resistance for internal communication	R _{BS}	• P14-P30 • P15-P31 • P14-P16 • P15-P17		4.5~5.5		130	300	Ω
Hysteresis voltage	V _{HIS}	Ports00-03,1 • RES#		4.5~5.5		0.35		V

6. μ -Controller Chip SIO0 Characteristics(*7) / $T_a = -10\text{deg}$ to $+65\text{deg}$, $V_{SS} = 0V$

Parameter	Symbol	Pins	Conditions	$V_{DD}[V]$	Limits			
					min	typ	max	unit
Serial Clock	Input Clock	SCK0(P02)	See the figure 4.	4.5~5.5	2			t _{CYC}
					1			
					1			
	Output Clock	SCK0(P02)	• Continuous data transmitting and receiving mode • See the figure 4. (*8)	4.5~5.5	4/3			t _{SCK}
						1/2		
						1/2		
Serial Input	Data setup time	SIO0(P01) SB0(P01)	• Define for rising of SIOCLK. • See the figure 4.	4.5~5.5	0.03			μs
					0.03			
Serial Output	Output delay time	SO0(P00) SB0(P01)	• Continuous data transmitting and receiving mode (*9) • Synchronous 8-bit mode (*9)	4.5~5.5			(1/3)t _{CYC} + 0.05	t _{CYC}
							1t _{CYC} + 0.05	
							(1/3)t _{CYC} + 0.05	

(*7) This limited value is theoretical figure. Be sure to ensure the margin in accordance with use situation.

(*8) When using the serial clock input with continuous data transmitting and receiving mode,

lengthen time from the set of the cereal clock of SIORUN in the state of "H" to the falling of the first cereal clock when it begins to send and receive continuous data more than t_{SCKHA}.

(*9) This is defined for falling of SIOCLK and it is defined as time until output change start in open drain output.

(See the figure 4)

7. μ -Controller Chip SIO1 Characteristics (*10) / Ta=-10deg to +65deg, VSS=0V

Parameter		Symbol	Pins	Conditions	V _{DD} [V]	Limits				
						min	typ	max	unit	
Serial Clock	Input Clock	Cycle	tSCK(3)	SCK1(P15)	See the figure 4.	4.5~5.5	2			tCYC
		Low level pulse-width	tSCKL(3)				1			
		High level pulse-width	tSCKH(3)				1			
	Output Clock	Cycle	tSCK(4)	SCK1(P15)	<ul style="list-style-type: none"> At the CMOS output selection See the figure 4. 	4.5~5.5	2			tSCK
		Low level pulse-width	tSCKL(4)				1/2			
		High level pulse-width	tSCKH(4)				1/2			
Serial Input	Data setup time	tsDI(2)	S11(P14) SB1(P14)	<ul style="list-style-type: none"> Define for rising of SIOCLK. See the figure 4. 	4.5~5.5	0.03			μ s	
	Data hold time	thDI(2)				0.03				
Serial Output	Output delay time	tdDO(4)	SO1(P16) SB1(P14)	<ul style="list-style-type: none"> Define for falling of SIOCLK. Define as time until output change start in open drain output. See the figure 4. 	4.5~5.5			(1/3)tCYC +0.05		

(*10) This limited value is theoretical figure. Be sure to ensure the margin in accordance with use situation.

8. μ -Controller Chip Pulse input conditions / Ta=-10deg to +65deg, VSS=0V

Parameter	Symbol	Pins	Conditions	V _{DD} [V]	Limits			
					min	typ	max	unit
High/low level pulse width	tPIH(1) tPIL(1)	INT0,INT1,INT2	<ul style="list-style-type: none"> Interrupt acceptable Timer0, 1 event input enabled 	4.5~5.5	1			tCYC
	tPIH(2) tPIL(2)	INT3/P03 (1/1 is selected for noise rejection clock.)	<ul style="list-style-type: none"> Interrupt acceptable Timer0, 1 event input enabled 	4.5~5.5	2			
	tPIH(3) tPIL(3)	INT3/P03 (1/32 is selected for noise rejection clock.)	<ul style="list-style-type: none"> Interrupt acceptable Timer0, 1 event input enabled 	4.5~5.5	64			
	tPIH(4) tPIL(4)	INT3/P03 (1/128 is selected for noise rejection clock.)	<ul style="list-style-type: none"> Interrupt acceptable Timer0, 1 event input enabled 	4.5~5.5	256			
	tPIL(5)	RES#	Reset acceptable	4.5~5.5	200			μ s

9. μ -Controller Chip AD converter characteristics / Ta=-10deg to +65deg, VSS=0V

Parameter	Symbol	Pins	Conditions	V _{DD} [V]	Limits			
					min	typ	max	unit
Resolution	N	AN3,		4.5~5.5		6		bit
Absolute precision	ET	AN4~AN7	(*11)				± 1	LSB
Conversion time	tCAD	(P04-P07)	Until result of conversion is ensured after Vref selection 1 bit conversion time $= 3 \times T_{cyc}$			0.636		μ s
Analog input voltage range	VAIN				VSS		VDD	V
Analog port input current	IAINH IAINL		VAIN=VDD VAIN=VSS		-1		1	μ A

(*11) Absolute precision does not include quantizing error (1/2LSB).

10. μ -Controller Chip Sample current dissipation characteristics / Ta=-10deg to +65deg, VSS=0V

The sample current dissipation characteristics is the measurement result of Sanyo provided evaluation board when the recommended circuit parameters shown in the sample oscillation circuit characteristics are used externally. The currents through the output transistors and the pull-up MOS transistors are ignored

Parameter	Symbol	Pins	Conditions	V _{DD} [V]	Limits			unit
					min	typ	max	
Current dissipation during basic operation (*12) (*13)	IDDOP(1)	CpuV _{DD}	·Reference clock=4.43MHz ·crystal oscillation ·System clock: V _{CO} (13.0MHz) ·VCO for OSD operating ·Built-in RC oscillation stops ·At the 1/1 frequency dividing ·OSD, DSL enabled	4.5~5.5		25	34	mA
	IDDOP(2)	CpuV _{DD}	·Reference clock=4.43MHz ·crystal oscillation ·System clock: reference clock frequency dividing (32kHz) ·V _{CO} for the main clock and for OSD stops ·Built-in RC oscillation stops ·At the 1/2 frequency dividing	4.5~5.5		2.0	3.1	mA
Current dissipation in HALT mode (*12) (*13)	IDDHALT(1)	CpuV _{DD}	·HALT mode ·Reference clock=4.43MHz ·crystal oscillation ·System clock: VCO (13.0MHz) ·VCO for OSD stops ·Built-in RC oscillation stops ·OSD, DSL enabled	4.5~5.5		4.8	7.5	mA
	IDDHALT(2)	CpuV _{DD}	·HALT mode ·Reference clock=4.43MHz ·crystal oscillation ·System clock: Built-in RC oscillation ·V _{CO} for the main clock and for OSD stops ·At the 1/1 frequency dividing	4.5~5.5		0.85	1.65	mA
	IDDHALT(3)	CpuV _{DD}	·HALT mode ·Reference clock=4.43MHz ·crystal oscillation ·System clock: reference clock frequency dividing (32kHz) ·V _{CO} for the main clock and for OSD stops ·Built-in RC oscillation stops ·At the 1/2 frequency dividing	4.5~5.5		0.82	1.54	mA
Current dissipation in HOLD mode (*13)	IDDHOLD	CpuV _{DD}	·HOLD mode ·All oscillation stop	4.5~5.5		0.8	1.5	mA

(*12) The currents of the output transistors and the internal pull-up MOS transistors are ignored.

(*13) 4.43MHz crystal oscillation current is contained.

11. μ -Controller Chip Crystal Oscillation Circuit and Sample Characteristics / $T_a = -10^{\circ}\text{C}$ to $+65^{\circ}\text{C}$, $V_{SS} = 0\text{V}$
 When the base timer count of clock accuracy is necessary, LC87F3664A can use the port terminal (P06, P07) as the crystal oscillation (See the Figure 1). The sample oscillation circuit characteristics and recommended oscillation circuit when port terminal (P06, P07) is used as XTAL oscillation terminal are shown below.

The sample oscillation circuit characteristics in the table below is based on the following conditions:

- Recommended circuit parameters are verified by an oscillator manufacturer using a Sanyo provided oscillation evaluation board.
- Sample characteristics are the result of the evaluation with the recommended circuit parameters connected externally.

Frequency	Manufacturer	Oscillator	Recommended circuit parameters				Operating supply voltage range	TmsXtal (*14) Oscillation stabilizing time		Notes
			C1	C2	Rf	Rd		Typ	max	
32.768kHz	Epson TOYOCOM	MC-306	18pF	18pF	OPEN	390k Ω	4.5~5.5V	1.0S	1.5S	Applicable CL value = 12.5pF SMD-type

(*14) The oscillation stabilization time refers to the time interval that is required for the oscillation to get stabilized after the instruction for starting the subclock oscillation circuit is executed and to the time interval that is required for the oscillation to get stabilized after the HOLD mode is reset (see the Figure 3).

The sample oscillation circuit characteristics may differ applications. For further assistance, please contact with oscillator manufacturer with the following notes in your mind.

- Since the oscillation frequency precision is affected by wiring capacity of the application board, etc., adjust the oscillation frequency on the production board.
- The above oscillation frequency and the operating supply voltage range are based on the operating temperature of -10°C to $+65^{\circ}\text{C}$. For the use with the temperature outside of the range herein, or in the applications requiring high reliability such as car products, please consult with oscillator manufacturer
- When using the oscillator which is not shown in the sample oscillation circuit characteristics, please consult with Sanyo sales personnel.

Since the oscillation circuit characteristics are affected by the noise or wiring capacity because the circuit is designed with low gain in order to reduce the power dissipation, refer to the following notices.

- The distance between the clock I/O terminal (P07/XT1 terminal P06/XT2 terminal) and external parts should be as short as possible.
- The capacitors' VSS should be allocated close to the microcontroller's CpuGND terminal and be away from other GND.
- The signal lines with rapid state changes or with large current should be allocated away from the oscillation circuit.

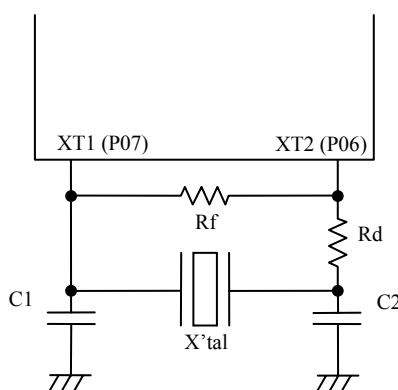

Figure 1 Recommended oscillation circuit.

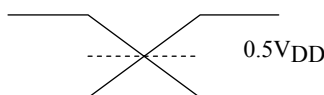

Figure 2 The Point of AC timing measure.

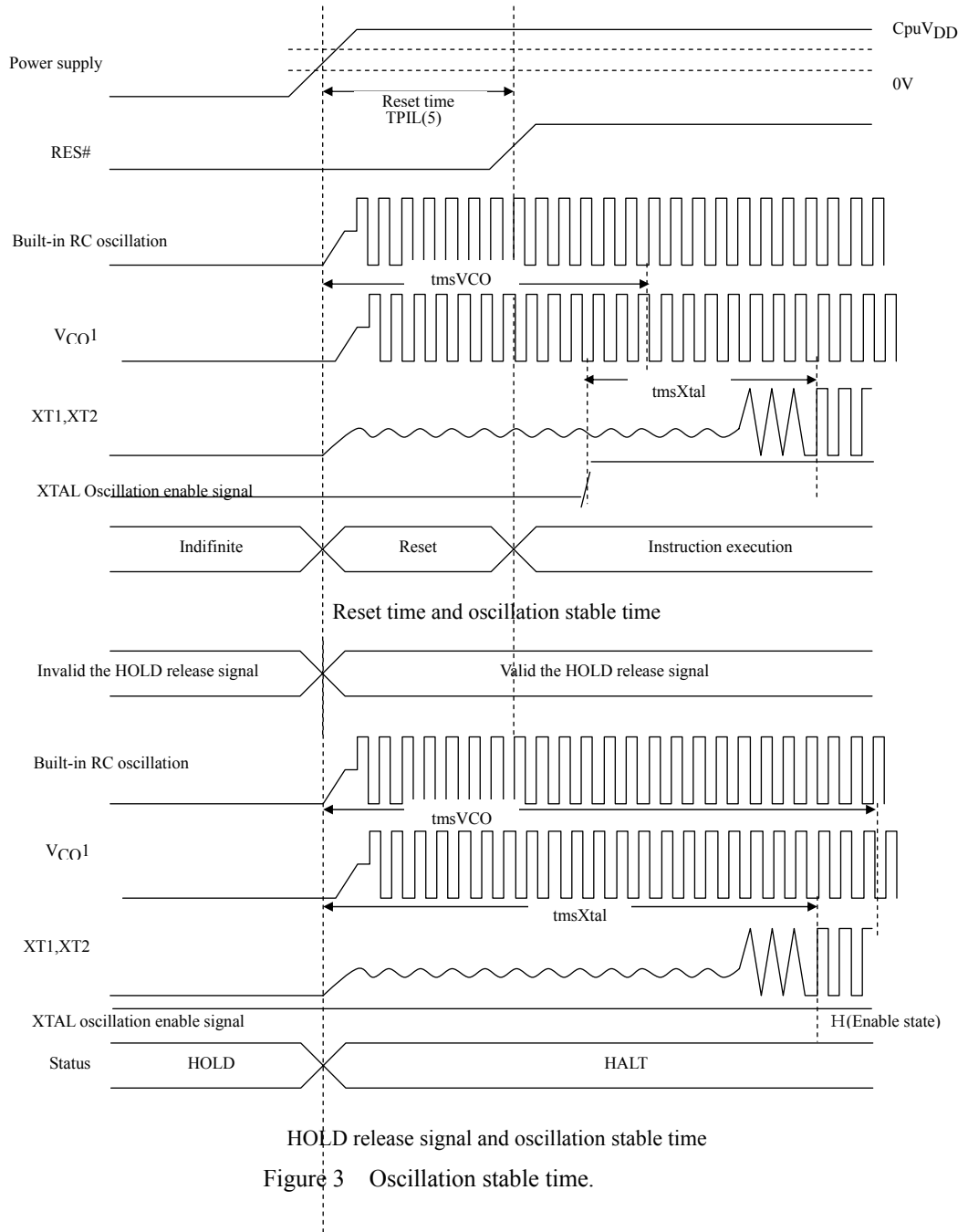

Figure 3 Oscillation stable time.

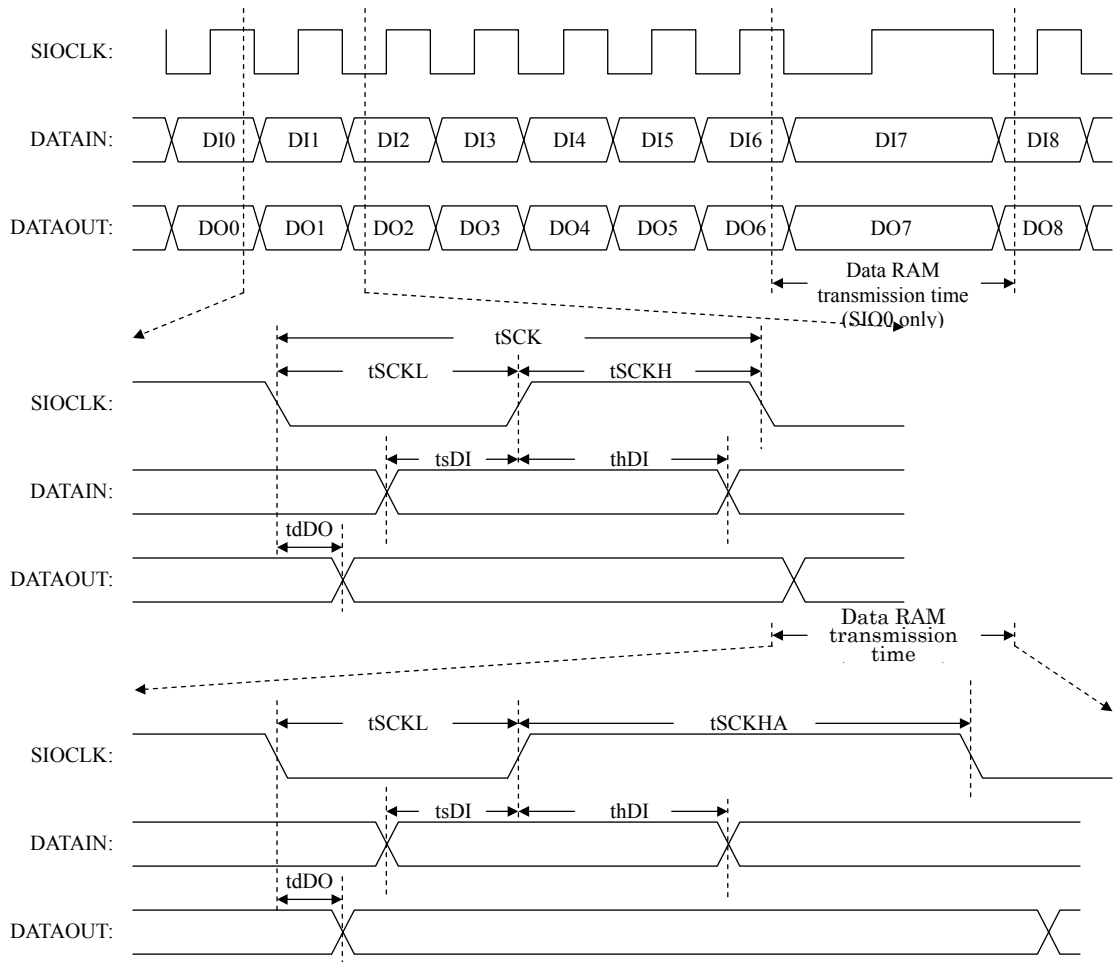

Figure 4 Serial I/O wave.

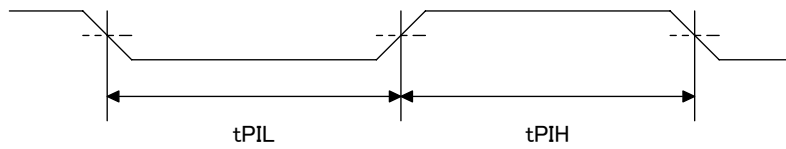

Figure 5 Pulse input timing wave.

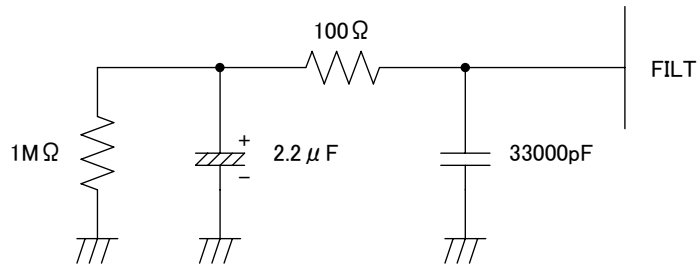

Figure 6 FILT recommended circuit.

(Note) Place FILT parts on board as close to the microcontroller as possible.

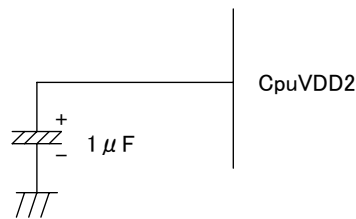

Figure 7 CpuVDD2 recommended circuit.

(Note) Place CpuVDD2 parts on board as close to the microcontroller as possible.

* Refer to the user's manual of LC873200 series, when you know the details about μ -Controller (LC873264A).

- SANYO Semiconductor Co.,Ltd. assumes no responsibility for equipment failures that result from using products at values that exceed, even momentarily, rated values (such as maximum ratings, operating condition ranges, or other parameters) listed in products specifications of any and all SANYO Semiconductor Co.,Ltd. products described or contained herein.
- SANYO Semiconductor Co.,Ltd. strives to supply high-quality high-reliability products, however, any and all semiconductor products fail or malfunction with some probability. It is possible that these probabilistic failures or malfunction could give rise to accidents or events that could endanger human lives, trouble that could give rise to smoke or fire, or accidents that could cause damage to other property. When designing equipment, adopt safety measures so that these kinds of accidents or events cannot occur. Such measures include but are not limited to protective circuits and error prevention circuits for safe design, redundant design, and structural design.
- In the event that any or all SANYO Semiconductor Co.,Ltd. products described or contained herein are controlled under any of applicable local export control laws and regulations, such products may require the export license from the authorities concerned in accordance with the above law.
- No part of this publication may be reproduced or transmitted in any form or by any means, electronic or mechanical, including photocopying and recording, or any information storage or retrieval system, or otherwise, without the prior written consent of SANYO Semiconductor Co.,Ltd.
- Any and all information described or contained herein are subject to change without notice due to product/technology improvement, etc. When designing equipment, refer to the "Delivery Specification" for the SANYO Semiconductor Co.,Ltd. product that you intend to use.
- Information (including circuit diagrams and circuit parameters) herein is for example only; it is not guaranteed for volume production.
- Upon using the technical information or products described herein, neither warranty nor license shall be granted with regard to intellectual property rights or any other rights of SANYO Semiconductor Co.,Ltd. or any third party. SANYO Semiconductor Co.,Ltd. shall not be liable for any claim or suits with regard to a third party's intellectual property rights which has resulted from the use of the technical information and products mentioned above.

This catalog provides information as of March, 2011. Specifications and information herein are subject to change without notice.