

# PRODUCT SPECIFICATION

DATE: 05/27/11'

<b>cosmo</b> ELECTRONICS CORPORATION	SOLID STATE RELAY :	NO. 58032215	REV.
	<b>KSD215AC3</b>	SHEET 1 OF 2	4

## 1. OUTSIDE DIMENSION : UNIT ( mm )

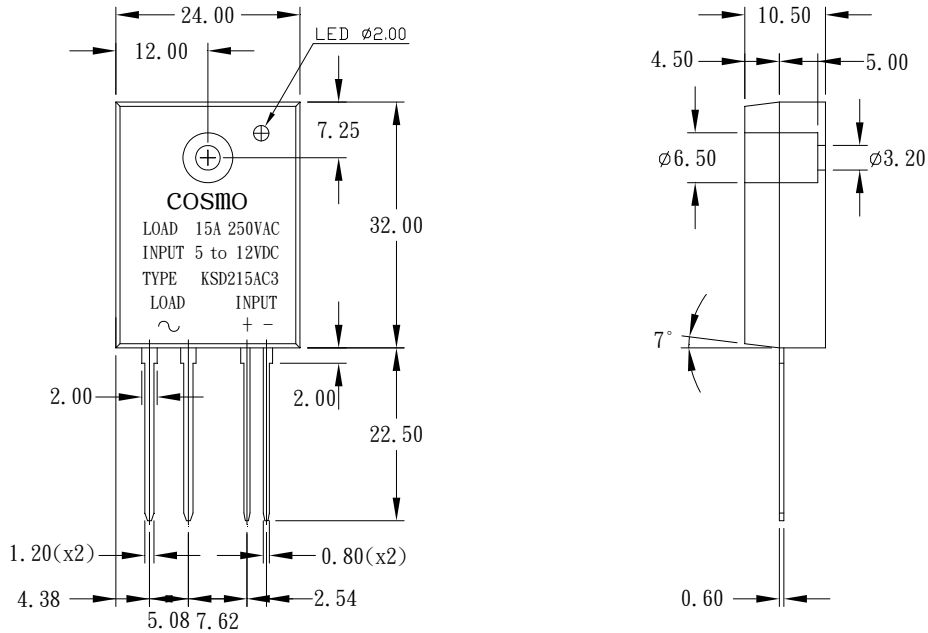

## 2. SCHEMATIC : TOP VIEW

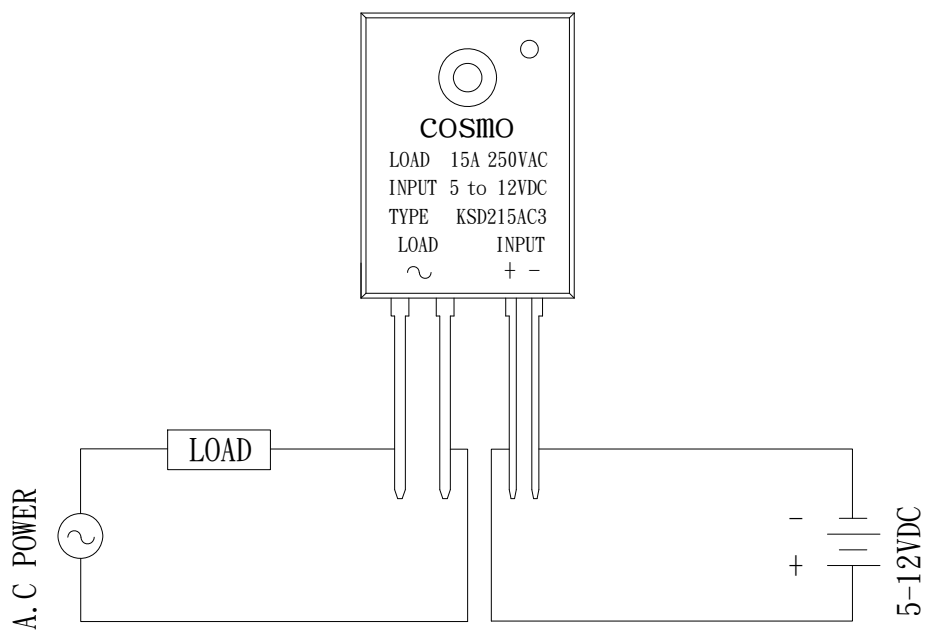

# PRODUCT SPECIFICATION

DATE: 05/27/11'

<b>cosmo</b> ELECTRONICS CORPORATION	SOLID STATE RELAY :	NO. 58032215	REV.
	<b>KSD215AC3</b>	SHEET 2 OF 2	4

## 3. Absolute Maximum Ratings

(Ta=25°C)

Parameter		Symbol	Rating	Unit
Input	Input signal voltage	$V_{IN}$	5-12	VDC
	Drop-out voltage	$V_{do}$	1	VDC
Output	RMS on-state current	$I_T$	15	Arms
	Peak one cycle surge current	$I_{surge}$	150	A
	Repetitive peak-off state voltage	$V_{DRM}$	600	V
	Operating frequency	f	47~70	Hz
	Critical rate of rise of on-state current	di/dt	50	A/us
	Load supply voltage	$V_{out}$	250	Vrms AC
Isolation voltage input to output		$V_{iso}$	4000	Vrms
Operating temperature		$T_{opr}$	-30~100	°C
Storage temperature		$T_{stg}$	-30~125	°C
Soldering temperature 10 sec		$T_{sol}$	260	°C

## 4. Electrical Characteristics

(Ta=25°C)

Parameter		Symbol	Conditions	MIN	TYP	MAX	Unit
Input	Pick-up voltage	$V_{pu}$	$I_t=1Arms$			4	VDC
	Input current	$I_{in}$	$V_{in}=5\sim 12V$	5		35	mA
Output	On-state voltage	$V_T$	$I_T=1Arms$			1.5	Vrms
	Operating current	$I_{op}$	$V_{out}=240vrms$	50			mArms
	Leakage current	$I_{leak}$	$V_{out}=240vrms$			7	mArms
	Critical rate of rise of off-state voltage	dv/dt		50	200		V/us
	Zero-cross voltage	$V_{ox}$			YES		
	Load Voltage Rating	$V_{out}$	$I_T=50mArms$ MIN	50		280	VAC
Minimum trigger current		$I_{FT}$	$V_{DRM}=600V$			25	mA
Isolation resistance input to output		$R_{ISO}$	DC500V	10			GΩ
Turn-on time		$T_{on}$	60Hz AC			8.3	mS
Turn-off time		$T_{off}$	60Hz AC			8.3	mS
Thermal resistance (between junction and case)		$R_{th}$ (j-c)			1.3		°C/W