

PRODUCT SPECIFICATION

DATE : 09/01/2006

cosmo ELECTRONICS CORPORATION	SOLID STATE RELAY - MOSFET OUTPUT KAQW612S	NO.62M22003 SHEET 1 OF 10	REV. 1

● OUTSIDE DIMENSION :

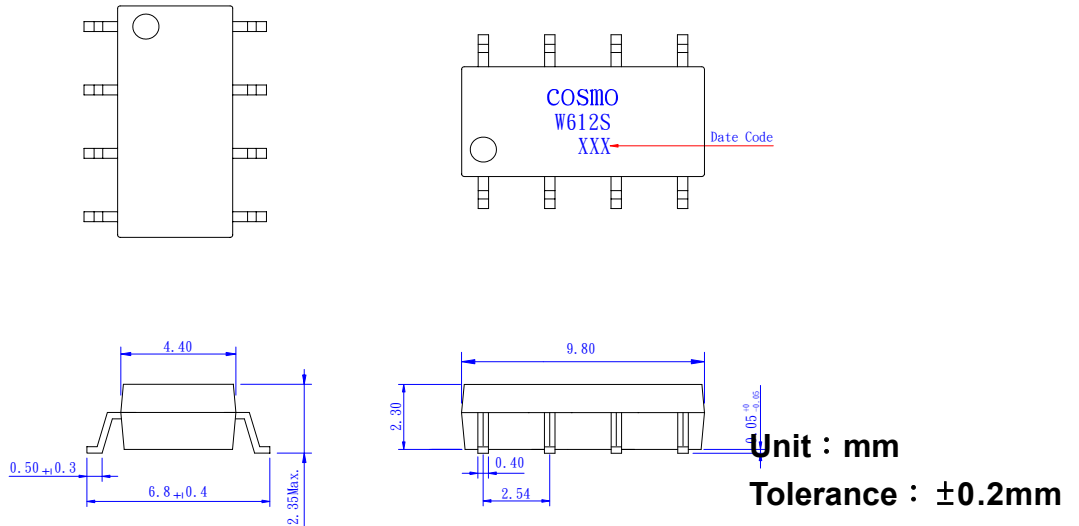

● Operate / Reverse time (N.C)

● Turn on / Turn off time (N.O)

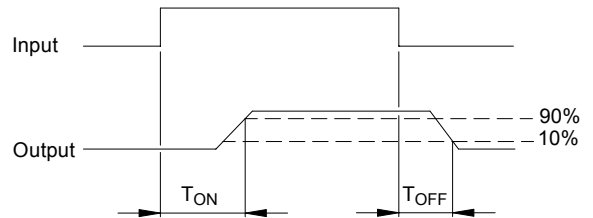
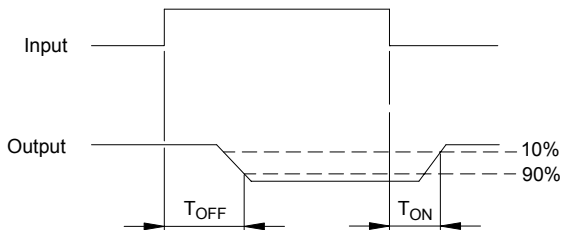

● Schematic and Wiring Diagrams

Schematic	Output Configuration	Load	Connection	Wiring Diagrams
	1a1b 1 FORM A/B 1 FORM C 	AC/DC	-	(1) Two independent 1 Form A & 1 Form B use (2) 1 Form A 1 Form B use

PRODUCT SPECIFICATION

DATE : 09/01/2006

cosmo ELECTRONICS CORPORATION	SOLID STATE RELAY - MOSFET OUTPUT	NO.62M22003	REV.
	KAQW612S	SHEET 2 OF 10	1

● Absolute Maximum Ratings

(Ta=25°C)

Emitter (Input)		Detector (Output)	
Reverse Voltage	5.0V	Output Breakdown Voltage	± 60V
Continuous Forward Current	50mA	Continuous Load Current	± 200mA
Peak Forward Current	1A	Power Dissipation	500mW
Power Dissipation	100mW		
Derate Linearly from 25°C	1.3mW/°C		

General Characteristics

Isolation Test Voltage	1500VACrms	Storage Temperature Range	-40°C to +125°C
Isolation Resistance		Operating Temperature Range ...	-40°C to +85°C
Viso=500V, Ta=25°C	≥ 10 ¹⁰ Ω	Junction Temperature	100°C
Total Power Dissipation	550mW	Soldering Temperature ,	
Derate Linearly from 25°C	2.5mW/°C	2mm from case , 10 sec	260°C

● Electro-optical Characteristics

(Ta=25°C)

Parameter	Symbol	Conditions	Min.	Typ.	Max.	Unit
Emitter (Input)						
Forward Voltage	V _F	I _F =10mA		1.2	1.5	V
Operation Input Current	I _{FON} (N.O) I _{FOFF} (N.C)	V _L =±20V, I _L =100mA (N.O) V _L =±20V, I _L ≤5μA (N.C) t=10ms			5	mA
Recovery Input Current	I _{FOFF} (N.O) I _{FON} (N.C)	V _L =±20V, I _L ≤5μA (N.C) V _L =±20V, I _L =100mA (N.O) t=10ms	0.2			mA

Detector (Output) normally open

Output Breakdown Voltage	V _B	I _B =50μA	60			V
Output Off-State Leakage	I _{TOFF}	V _T =100V, I _F =0mA		0.2	1	μA
I/O Capacitance	C _{ISO}	I _F =0, f=1MHz		6		pF
ON Resistance	R _{ON}	I _L =100mA, I _F =10mA		0.83	2.5	Ω
Turn-On Time	T _{ON}	I _F =10mA, V _L =±20V		0.2	1.5	ms
Turn-Off Time	T _{OFF}	t=10mS, I _L =±100mA		0.3	1.5	ms

Detector (Output) normally close

Output Breakdown Voltage	V _B	I _B =50μA, I _F =10mA	60			V
Output Off-State Leakage	I _{TOFF}	V _T =100V, I _F =10mA		0.2	2	μA
I/O Capacitance	C _{ISO}	I _F =0, f=1MHz		6		pF
ON Resistance	R _{ON}	I _L =100mA, I _F =0mA		2.5	5	Ω
Operate (OFF) Time	T _{OFF}	I _F =10mA, V _L =±20V		0.6	1.5	ms
Reverse (ON) Time	T _{ON}	t=10ms, I _L =±100mA		0.3	1.5	ms

PRODUCT SPECIFICATION

DATE : 09/01/2006

cosmo ELECTRONICS CORPORATION	SOLID STATE RELAY - MOSFET OUTPUT	NO.62M22003	REV. 1
	KAQW612S	SHEET 3 OF 10	

● Data Curve (Normally Open Characteristics)

Load current vs. ambient temperature
 Allowable ambient Temperature :
 -40°C to +85°C

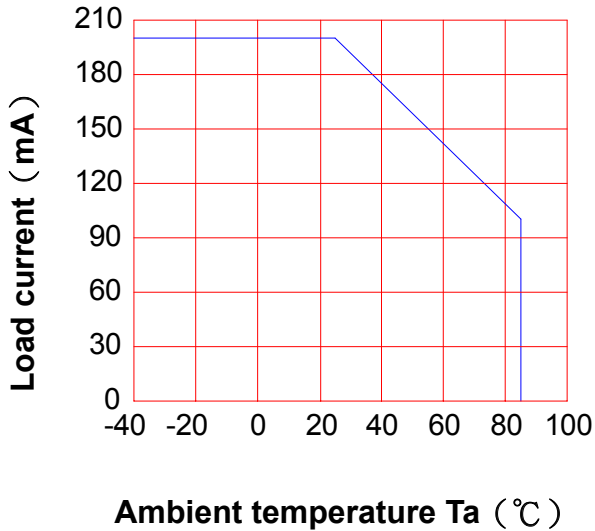

On resistance vs. ambient temperature
 across terminals 5 and 6 pin
 LED current : 5mA
 Continuous load current : 200mA (DC)

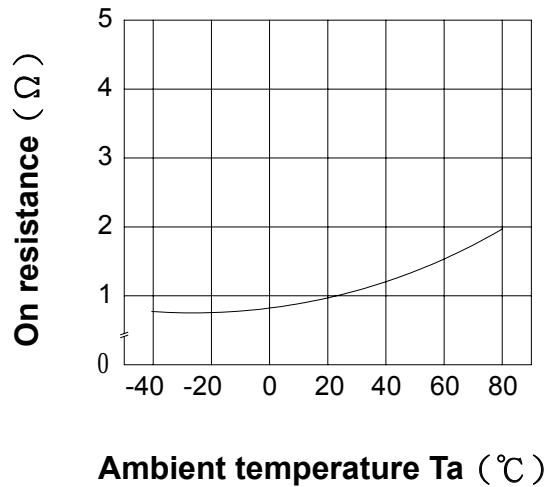

Turn on time vs. ambient temperature
 Load voltage 60V (DC)
 LED current : 5mA
 Continuous load current : 200mA (DC)

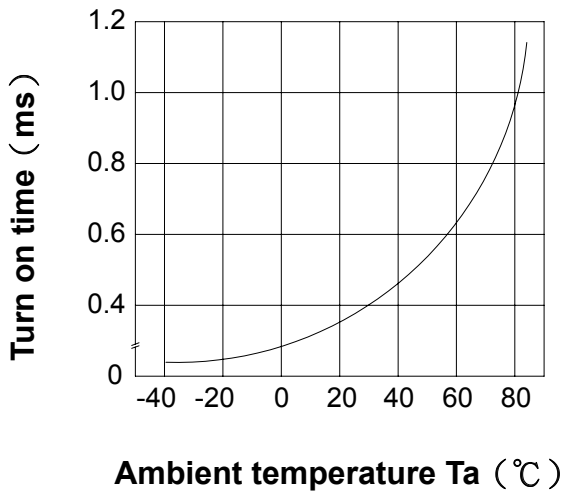

Turn off time vs. ambient temperature
 Load voltage 60V (DC)
 LED current : 5mA
 Continuous load current : 200mA (DC)

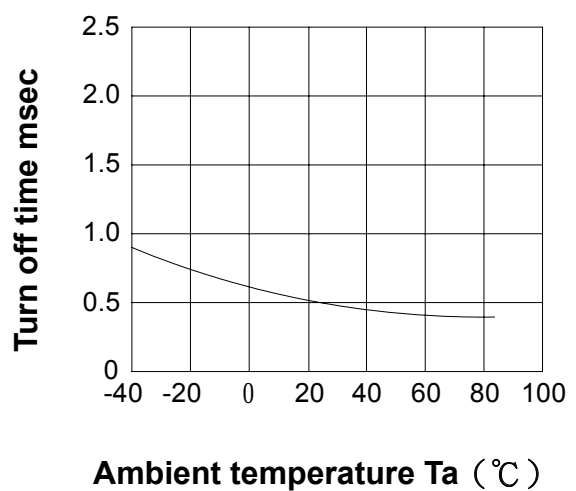

PRODUCT SPECIFICATION

DATE : 09/01/2006

cosmo
ELECTRONICS CORPORATION

SOLID STATE RELAY - MOSFET OUTPUT
KAQW612S

NO.62M22003
SHEET 4 OF 10

REV.
1

LED operate current vs.
ambient temperature

Load Voltage : 60V (DC)

Continuous load current : 200mA (DC)

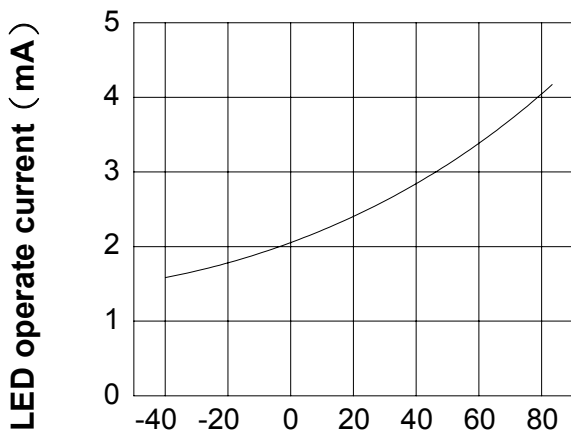

Ambient temperature Ta (°C)

LED Turn Off current vs.
ambient temperature

Load Voltage : 60V (DC)

Continuous load current : 200mA (DC)

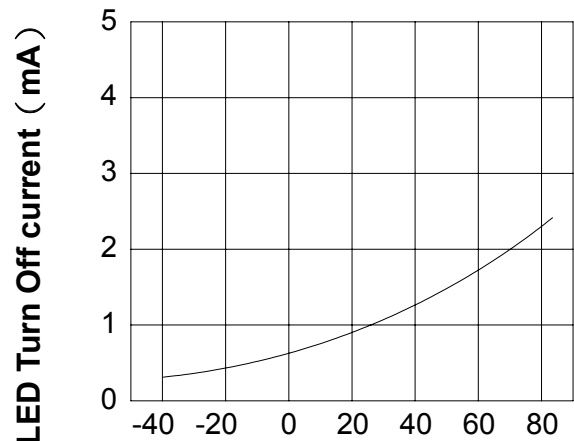

Ambient temperature Ta (°C)

LED dropout voltage vs.
ambient temperature

LED current : 5 to 50mA

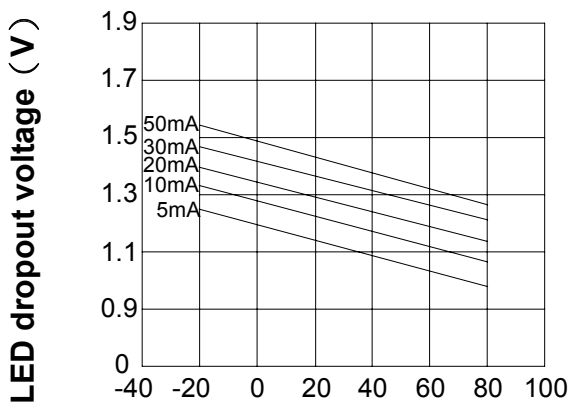

Ambient temperature Ta (°C)

Voltage vs. current characteristics
of output at MOSFET portion

Measured portion : across terminals
5 and 6 pin

Ambient temperature : 25°C

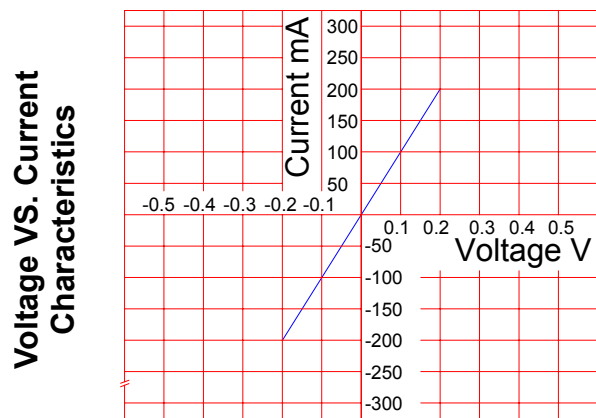

Ambient temperature : 25°C

PRODUCT SPECIFICATION

DATE : 09/01/2006

cosmo ELECTRONICS CORPORATION	SOLID STATE RELAY - MOSFET OUTPUT KAQW612S	NO.62M22003	REV. 1
		SHEET 5 OF 10	

LED forward current vs. turn on time
Across terminals 5 and 6 pin
Load voltage : 60V (DC)
Continuous load current : 200mA (DC)
Ambient temperature : 25°C

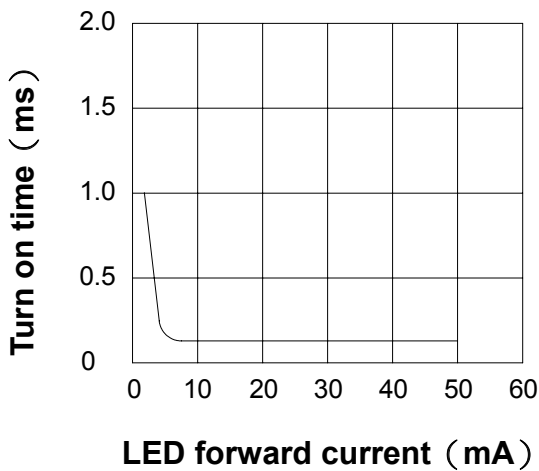

Off state leakage current
Across terminals 5 and 6 pin
Ambient temperature : 25°C

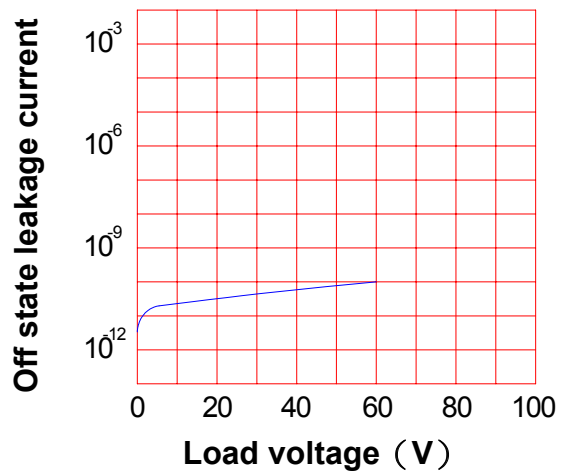

LED forward current vs. turn off time
Across terminals 5 and 6 pin
Load voltage : 60V (DC)
Continuous load current : 200mA (DC)
Ambient temperature : 25°C

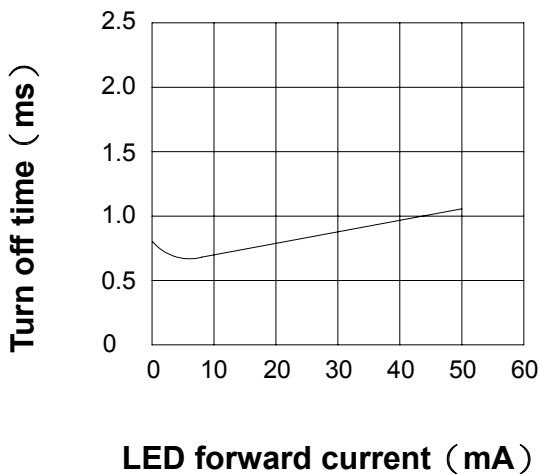

Applied voltage vs. output capacitance
Across terminals 5 and 6 pin
Frequency : 1MHz
Ambient temperature : 25°C

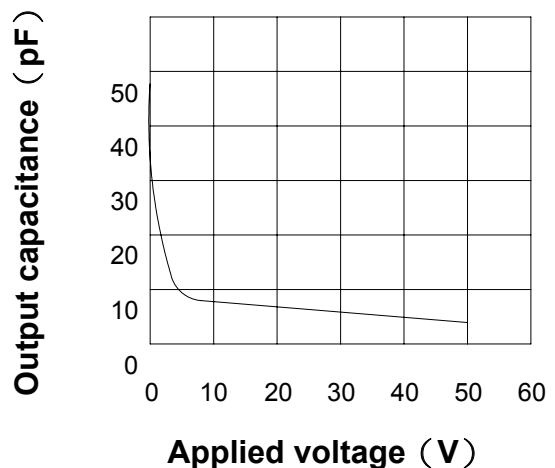

PRODUCT SPECIFICATION

DATE : 09/01/2006

cosmo ELECTRONICS CORPORATION	SOLID STATE RELAY - MOSFET OUTPUT	NO.62M22003	REV. 1
	KAQW612S	SHEET 6 OF 10	

● Data Curve (Normally Close Characteristics)

Load current vs. ambient temperature
 Allowable ambient Temperature :
 -40°C to +85°C

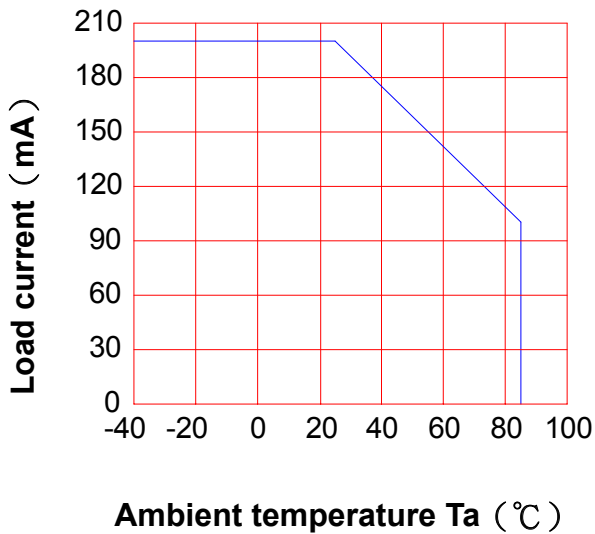

On resistance vs. ambient temperature
 across terminals 7 and 8 pin
 LED current : 0mA
 Continuous load current : 200mA (DC)

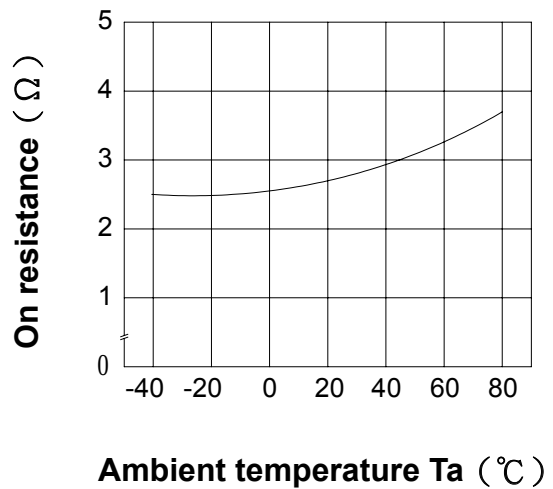

Operate (OFF) time vs.
 ambient temperature
 Load voltage 60V (DC)
 LED current : 5mA
 Continuous load current : 200mA (DC)

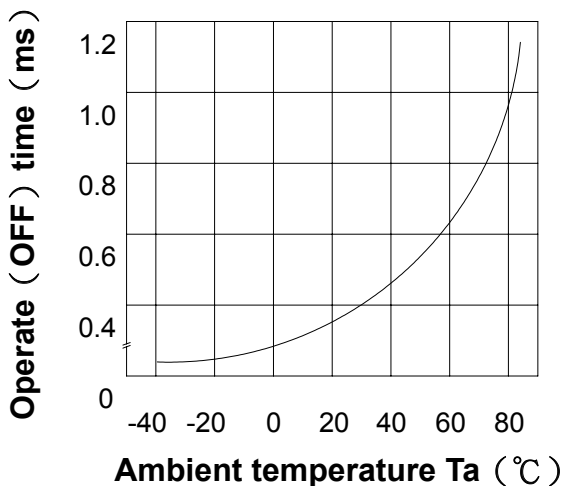

Reverse (ON) time vs.
 ambient temperature
 Load voltage 60V (DC)
 LED current : 5mA
 Continuous load current : 200mA (DC)

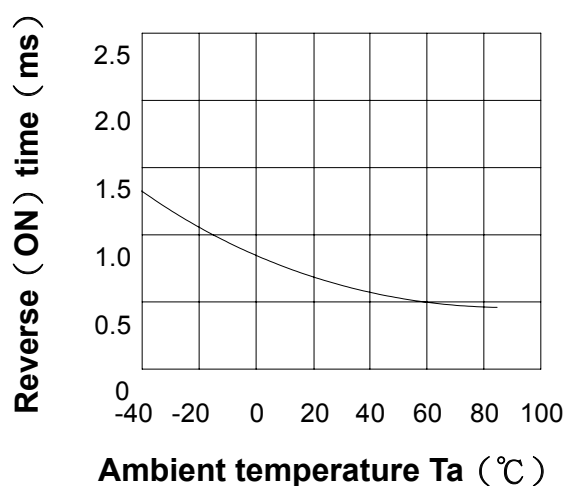

PRODUCT SPECIFICATION

DATE : 09/01/2006

cosmo ELECTRONICS CORPORATION	SOLID STATE RELAY - MOSFET OUTPUT	NO.62M22003	REV. 1
	KAQW612S	SHEET 7 OF 10	

LED Operate (OFF) current vs. ambient temperature

Load Voltage : 60V (DC)

Continuous load current : 200mA (DC)

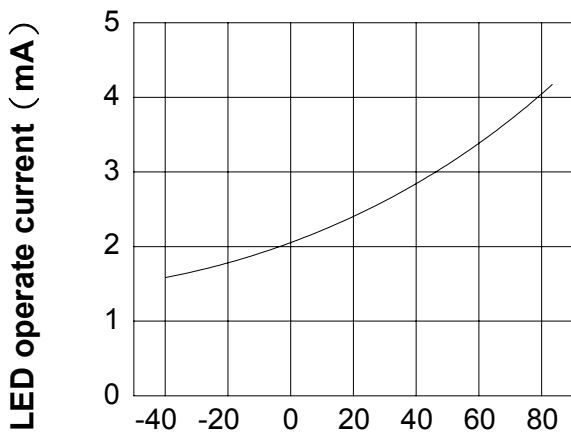

Ambient temperature Ta (°C)

LED Reverse (ON) current vs. ambient temperature

Load Voltage : 60V (DC)

Continuous load current : 200mA (DC)

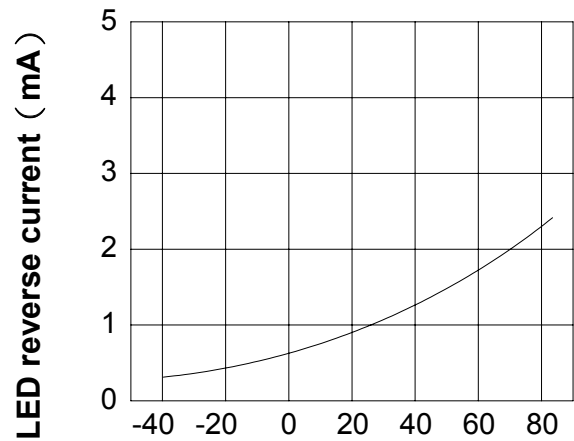

Ambient temperature Ta (°C)

LED dropout voltage vs. ambient temperature

LED current : 5 to 50mA

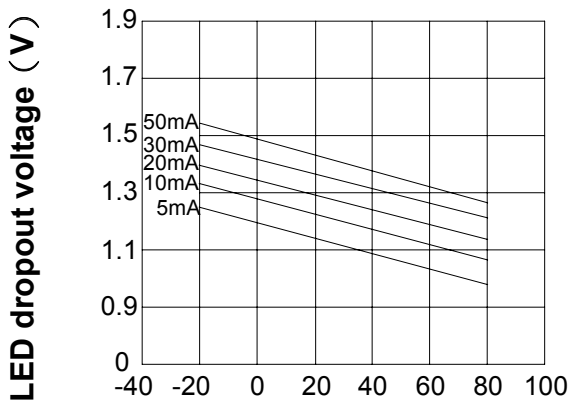

Ambient temperature Ta (°C)

Voltage vs. current characteristics of output at MOSFET portion

Measured portion : across terminals 7 and 8 pin

Ambient temperature : 25°C

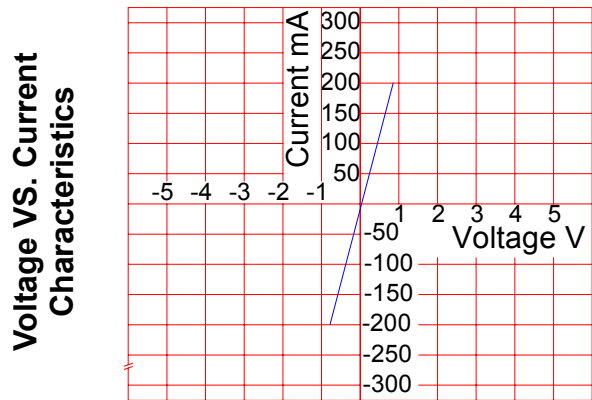

Ambient temperature : 25°C

PRODUCT SPECIFICATION

DATE : 09/01/2006

cosmo ELECTRONICS CORPORATION	SOLID STATE RELAY - MOSFET OUTPUT KAQW612S	NO.62M22003	REV. 1
		SHEET 8 OF 10	

LED forward current vs. operate (OFF) time
Across terminals 7 and 8 pin
Load voltage : 60V (DC)
Continuous load current : 200mA (DC)
Ambient temperature : 25°C

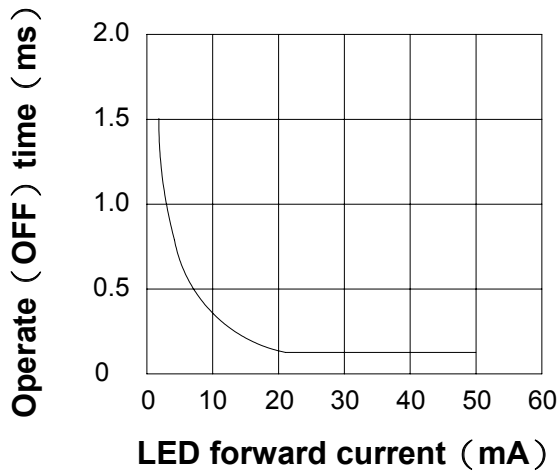

Off state leakage current
Across terminals 7 and 8 pin
Ambient temperature : 25°C

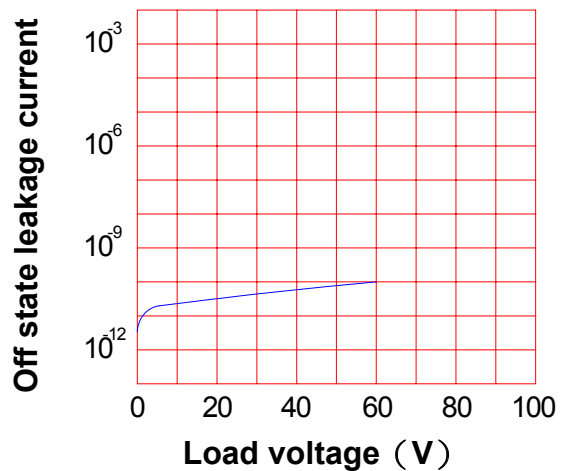

LED forward current vs. reverse (ON) time
Across terminals 7 and 8 pin
Load voltage : 60V (DC)
Continuous load current : 200mA (DC)
Ambient temperature : 25°C

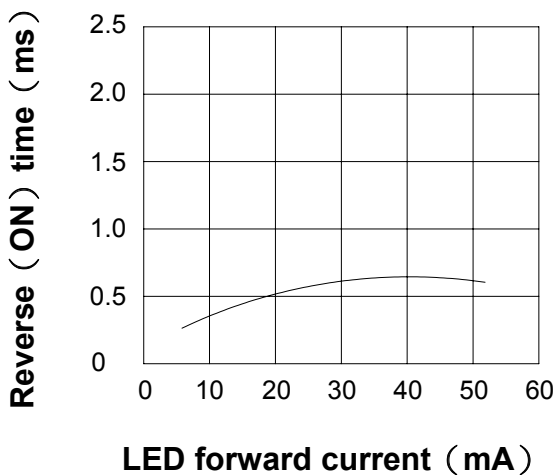

Applied voltage vs. output capacitance
Across terminals 7 and 8 pin
Frequency : 1MHz
Ambient temperature : 25°C

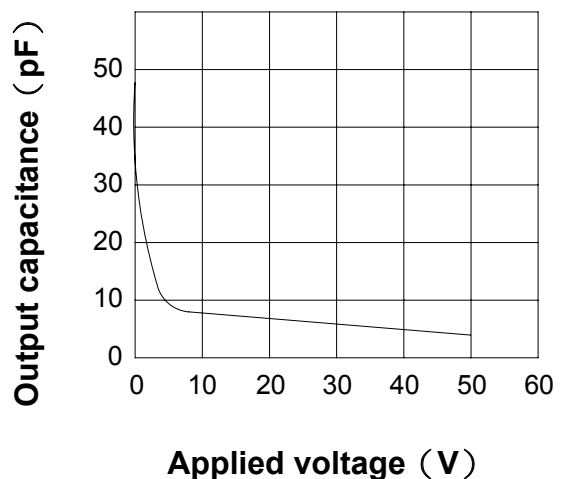

PRODUCT SPECIFICATION

DATE : 09/01/2006

cosmo ELECTRONICS CORPORATION	SOLID STATE RELAY - MOSFET OUTPUT	NO.62M22003	REV. 1
	KAQW612S	SHEET 9 OF 10	

● USING METHODS

Examples of resistance value to control LED forward current (I_F)

SSR-MOSFET OUTPUT

($I_F=5\text{mA}$)

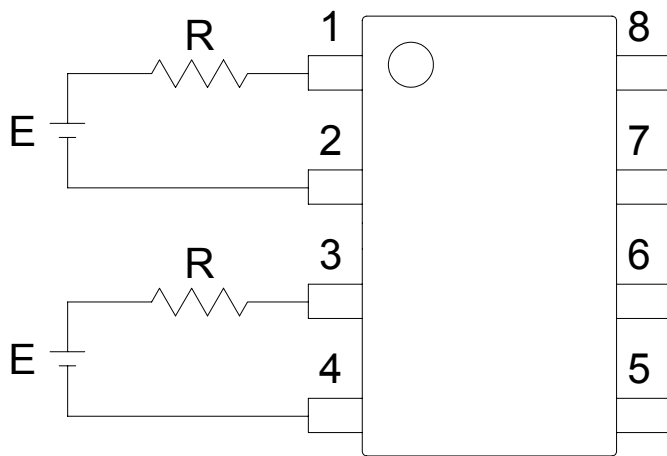

E	R
3.3V	Approx. 330 Ω
5V	Approx. 640 Ω
12V	Approx. 1.9K Ω
15V	Approx. 2.5K Ω
24V	Approx. 4.1K Ω

- (1) LED forward current must be more than 5mA , at E min.
- (2) LED forward current must be less than 50mA , at E max.

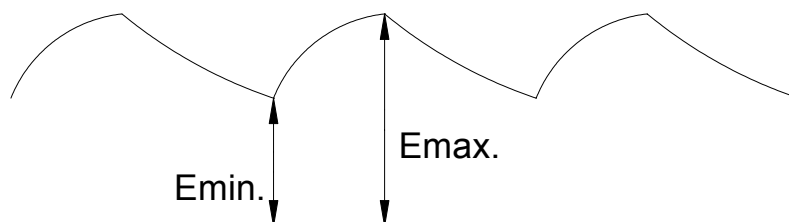

PRODUCT SPECIFICATION

DATE : 09/01/2006

cosmo ELECTRONICS CORPORATION	SOLID STATE RELAY - MOSFET OUTPUT KAQW612S	NO.62M22003	REV. 1
		SHEET 10 OF 10	

● USING METHODS

Regulate the spike voltage generated on the inductive load as follows :

