

# PRODUCT SPECIFICATION

DATE : 09/01/2006

<b>cosmo</b> ELECTRONICS CORPORATION	SOLID STATE RELAY - MOSFET OUTPUT	NO.60M10027	REV. 1
	<b>KAQV213</b>	SHEET 1 OF 7	

● **OUTSIDE DIMENSION :**

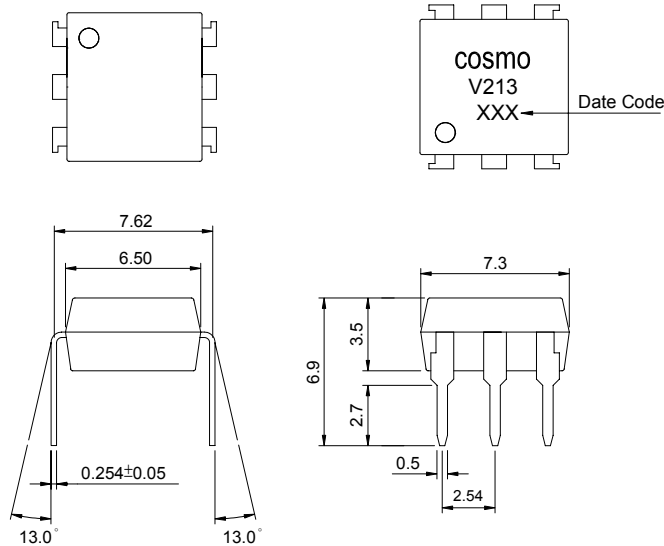

Unit : mm  
Tolerance : ±0.2mm

● **Turn On / Turn Off time**

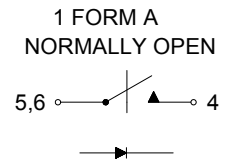
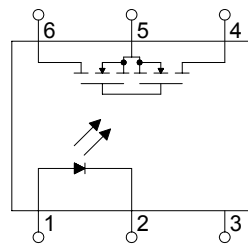
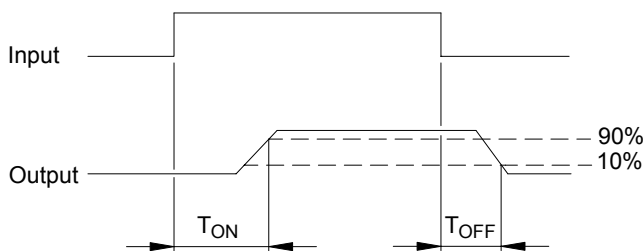

● **Absolute Maximum Ratings**

( Ta=25°C )

Emitter ( Input )	Detector ( Output )
Reverse Voltage ..... 5.0V	Output Breakdown Voltage ..... ± 250V
Continuous Forward Current ..... 50mA	Continuous Load Current ..... ± 200mA
Peak Forward Current ..... 1A	Power Dissipation ..... 500mW
Power Dissipation ..... 100mW	
Derate Linearly from 25°C ..... 1.3mW/°C	
<b>General Characteristics</b>	
Isolation Test Voltage ..... 5000VACrms	Storage Temperature Range ..... -40°C to +125°C
Isolation Resistance	Operating Temperature Range ... -40°C to +85°C
Vio=500V , Ta=25°C ..... ≥ 10 <sup>10</sup> Ω	Junction Temperature ..... 100°C
Total Power Dissipation ..... 550mW	Soldering Temperature ,
Derate Linearly from 25°C ..... 2.5mW/°C	2mm from case , 10 sec ..... 260°C

# PRODUCT SPECIFICATION

DATE : 09/01/2006

<b>cosmo</b> ELECTRONICS CORPORATION	SOLID STATE RELAY - MOSFET OUTPUT	NO.60M10027	REV.
	<b>KAQV213</b>	SHEET 2 OF 7	1

## ● Electro-optical Characteristics

(Ta=25°C)

Parameter	Symbol	Conditions	Min.	Typ.	Max.	Unit.	
Emitter ( Input )							
Forward Voltage	$V_F$	$I_F=10\text{mA}$		1.2	1.5	V	
Operation Input Current	$I_{F\text{ON}}$	$V_L=\pm 20\text{V}$ , $I_L=100\text{mA}$ , $t=10\text{ms}$			5.0	mA	
Recovery Input Current	$I_{F\text{OFF}}$	$V_L=\pm 20\text{V}$ , $I_L \leq 5\mu\text{A}$	0.2			mA	
Detector ( Output )							
Output Breakdown Voltage	$V_B$	$I_B=50\mu\text{A}$	250			V	
Output Off-State Leakage	$I_{T\text{OFF}}$	$V_T=100\text{V}$ , $I_F=0\text{mA}$		0.2	1	$\mu\text{A}$	
I/O Capacitance	$C_{\text{ISO}}$	$I_F=0$ , $f=1\text{MHz}$		6		pF	
ON Resistance	Connection	A	$I_L=100\text{mA}$ , $I_F=10\text{mA}$		8	16	$\Omega$
		B			4	8	
		C			2	4	
Turn-On Time	$T_{\text{ON}}$	$I_F=10\text{mA}$ , $V_L=\pm 20\text{V}$		0.3	1.0	ms	
Turn-Off Time	$T_{\text{OFF}}$	$t=10\text{ms}$ , $I_L=\pm 100\text{mA}$		0.5	1.5	ms	

## ● Schematic and Wiring Diagrams

Schematic	Output Configuration	Load	Connection	Wiring Diagrams
	1a	AC/DC	A	
		DC	B	
			C	

# PRODUCT SPECIFICATION

DATE : 09/01/2006

<b>cosmo</b> ELECTRONICS CORPORATION	SOLID STATE RELAY - MOSFET OUTPUT	NO.60M10027	REV.
	<b>KAQV213</b>	SHEET 3 OF 7	1

## ● Data Curve

**Load current vs. ambient temperature**  
 Allowable ambient Temperature :  
 -40°C to +85°C

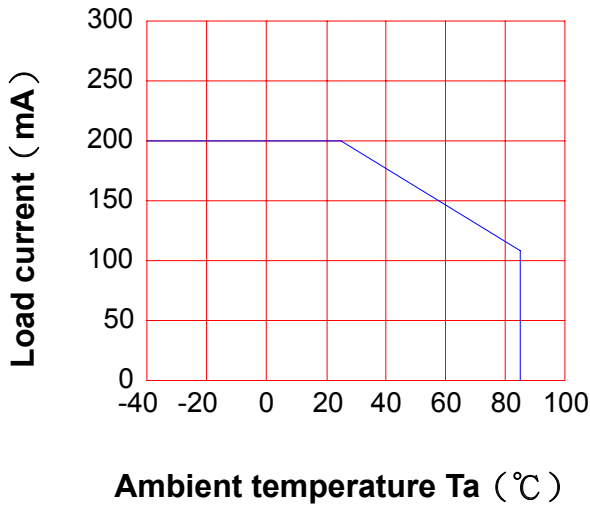

**On resistance vs. ambient temperature across terminals 4 and 6 pin**  
 LED current : 5mA  
 Continuous load current : 200mA (DC)

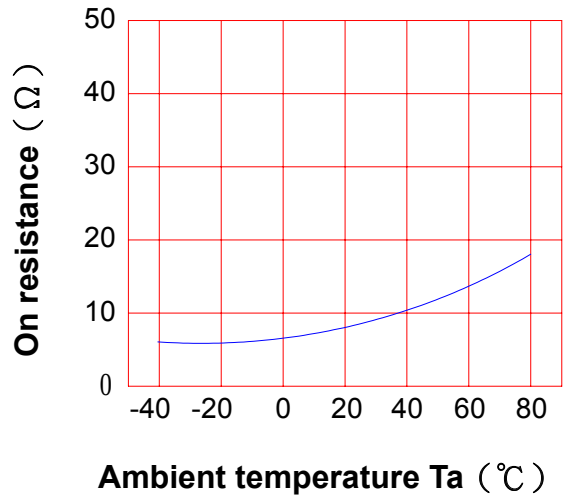

**Turn On Time vs. ambient temperature**  
 Load voltage 250V (DC)  
 LED current : 5mA  
 Continuous load current : 200mA (DC)

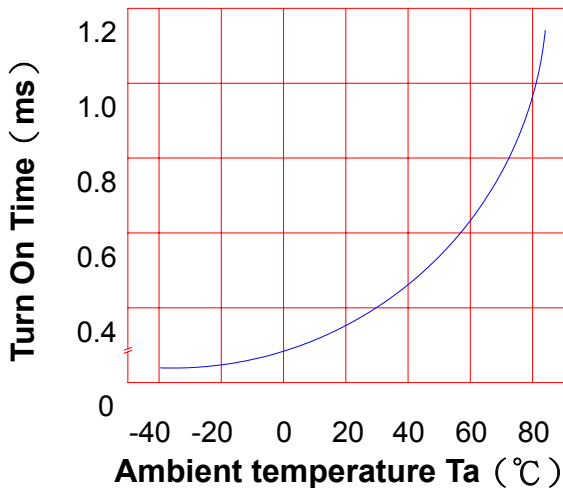

**Turn Off Time vs. ambient temperature**  
 Load voltage 250V (DC)  
 LED current : 5mA  
 Continuous load current : 200mA (DC)

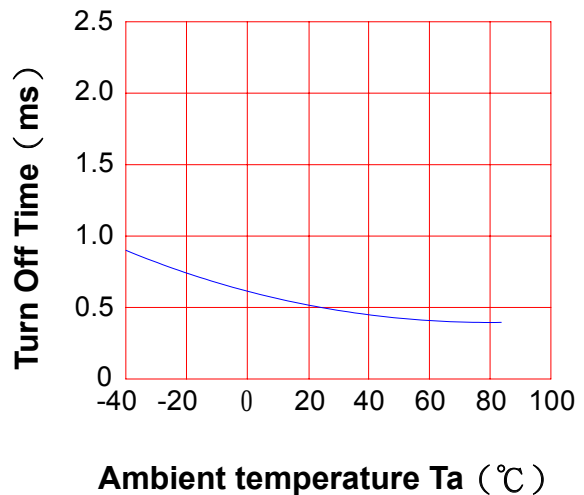

# PRODUCT SPECIFICATION

DATE : 09/01/2006

**cosmo**  
ELECTRONICS CORPORATION

SOLID STATE RELAY - MOSFET OUTPUT  
**KAQV213**

NO.60M10027  
SHEET 4 OF 7

REV.  
1

LED operate current vs.  
ambient temperature

Load Voltage : 250V (DC)

Continuous load current : 200mA (DC)

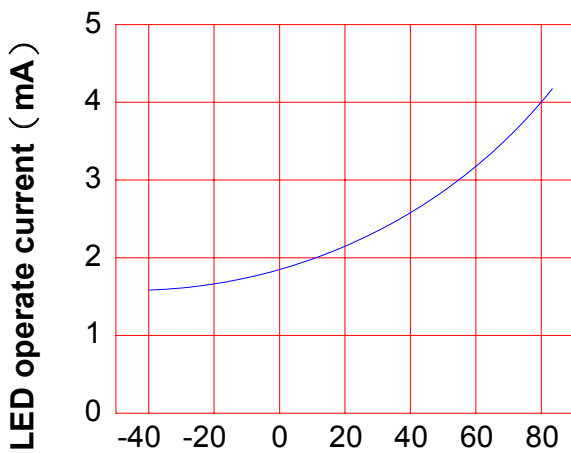

Ambient temperature Ta (°C)

LED Turn Off current vs.  
ambient temperature

Load Voltage : 250V (DC)

Continuous load current : 200mA (DC)

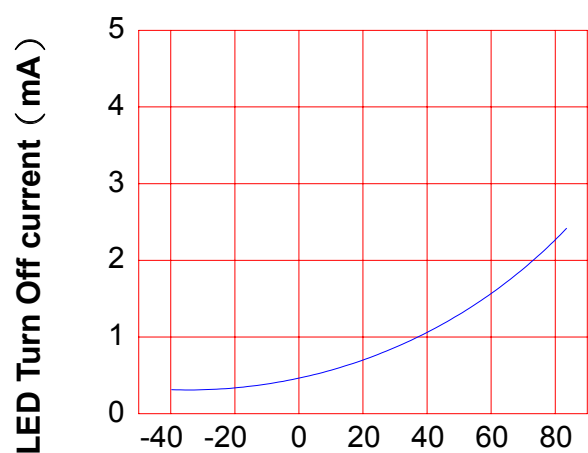

Ambient temperature Ta (°C)

LED dropout voltage vs.  
ambient temperature

LED current : 5 to 50mA

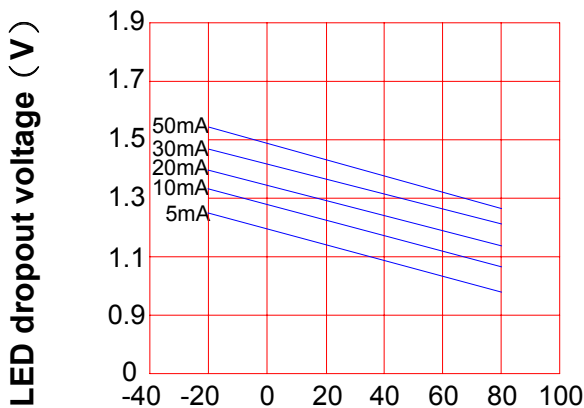

Ambient temperature Ta (°C)

Voltage vs. current characteristics  
of output at MOSFET portion  
Measured portion : across terminals  
4 and 6 pin

Ambient temperature : 25°C

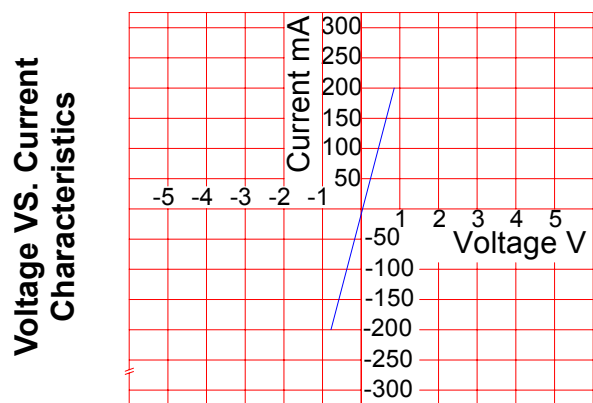

Ambient temperature : 25°C

# PRODUCT SPECIFICATION

DATE : 09/01/2006

<b>cosmo</b> ELECTRONICS CORPORATION	SOLID STATE RELAY - MOSFET OUTPUT	NO.60M10027	REV. 1
	<b>KAQV213</b>	SHEET 5 OF 7	

**LED forward current vs. Turn On Time**  
 Across terminals 4 and 6 pin  
 Load voltage : 250V (DC)  
 Continuous load current : 200mA (DC)  
 Ambient temperature : 25°C

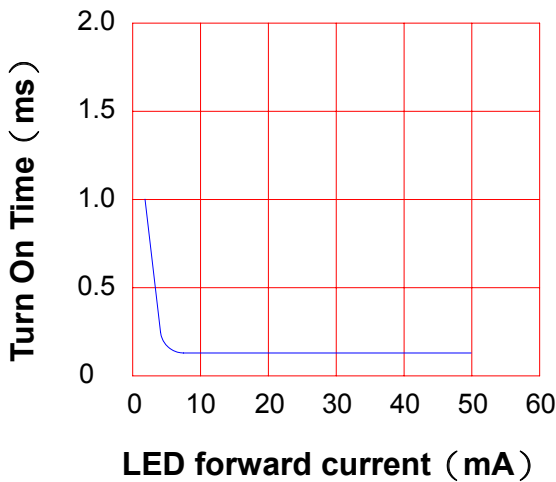

**Off state leakage current**  
 Across terminals 4 and 6 pin  
 Ambient temperature : 25°C

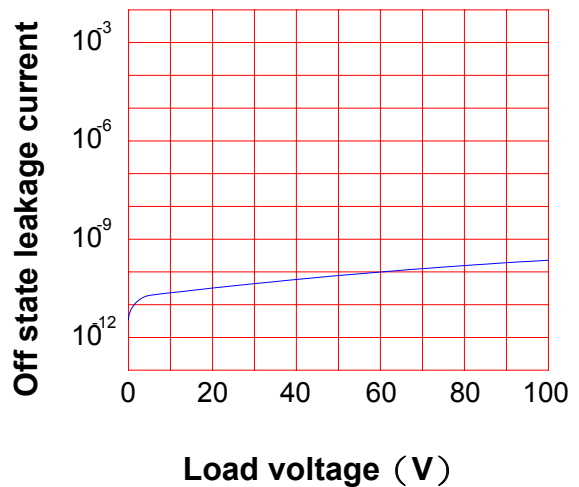

**LED forward current vs. reverse(ON) time**  
 Across terminals 4 and 6 pin  
 Load voltage : 250V (DC)  
 Continuous load current : 200mA (DC)  
 Ambient temperature : 25°C

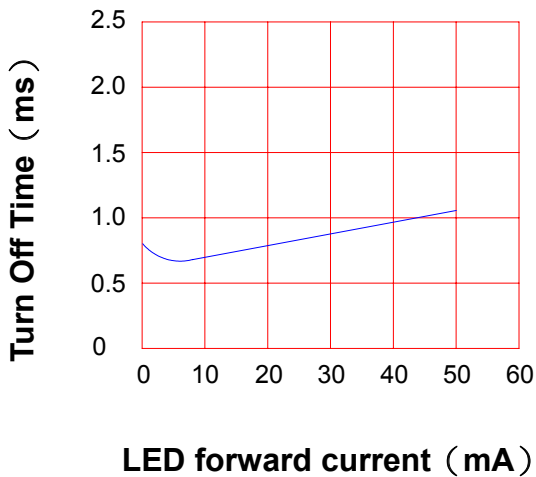

**Applied voltage vs. output capacitance**  
 Across terminals 4 and 6 pin  
 Frequency : 1MHz  
 Ambient temperature : 25°C

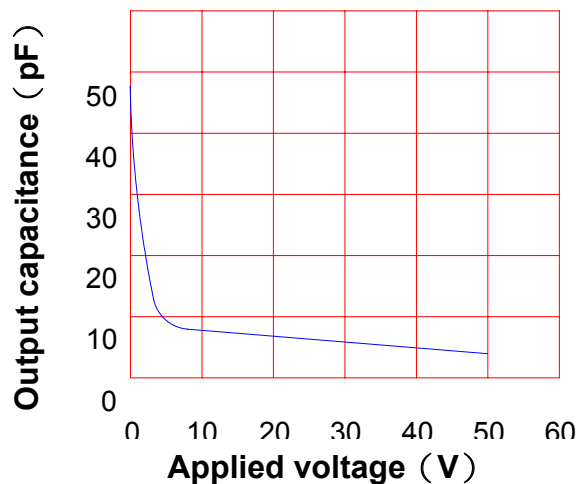

# PRODUCT SPECIFICATION

DATE : 09/01/2006

<b>cosmo</b> ELECTRONICS CORPORATION	SOLID STATE RELAY - MOSFET OUTPUT <b>KAQV213</b>	NO.60M10027	REV. 1
		SHEET 6 OF 7	

## ● USING METHODS

Examples of resistance value to control LED forward current ( $I_F$ )

SSR-MOSFET OUTPUT

( $I_F=5\text{mA}$ )

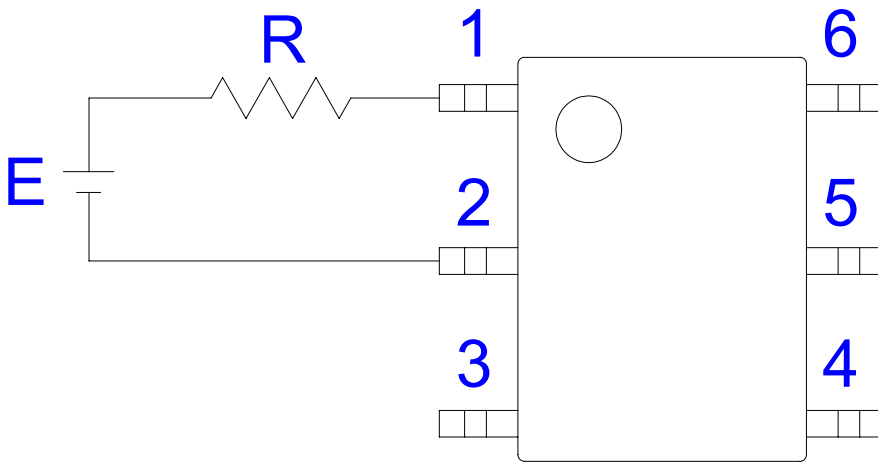

E	R
3.3V	Approx. 330 $\Omega$
5V	Approx. 640 $\Omega$
12V	Approx. 1.9K $\Omega$
15V	Approx. 2.5K $\Omega$
24V	Approx. 4.1K $\Omega$

- (1) LED forward current must be more than 5mA , at E min.
- (2) LED forward current must be less than 50mA , at E max.

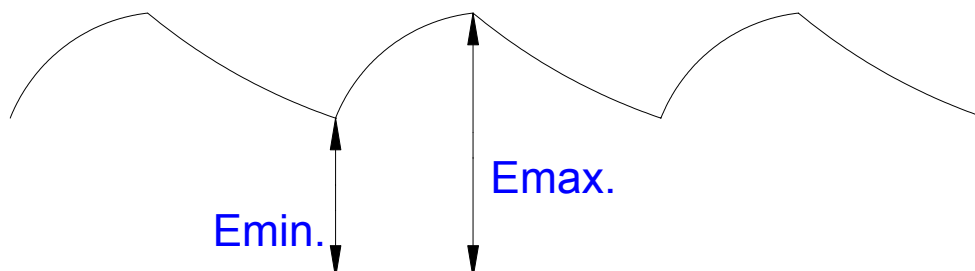

# PRODUCT SPECIFICATION

DATE : 09/01/2006

**cosmo**  
ELECTRONICS CORPORATION

SOLID STATE RELAY - MOSFET OUTPUT  
**KAQV213**

NO.60M10027  
SHEET 7 OF 7

REV.  
1

## ● USING METHODS

Regulate the spike voltage generated on the inductive load as follows :

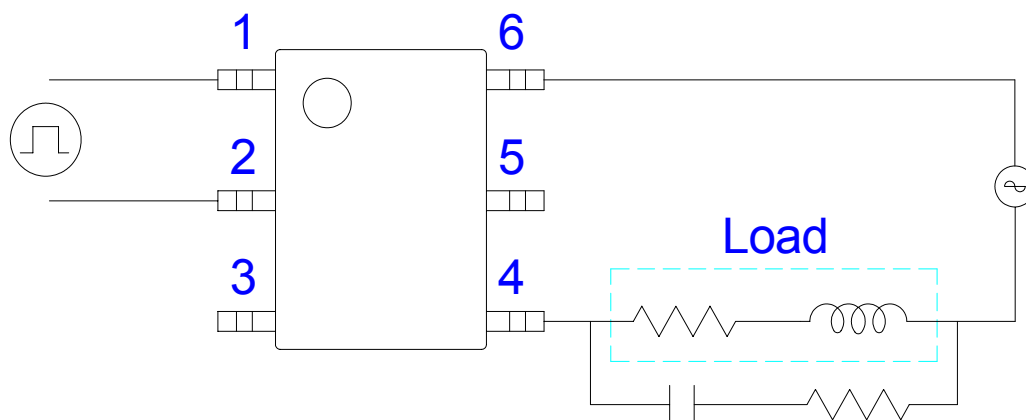
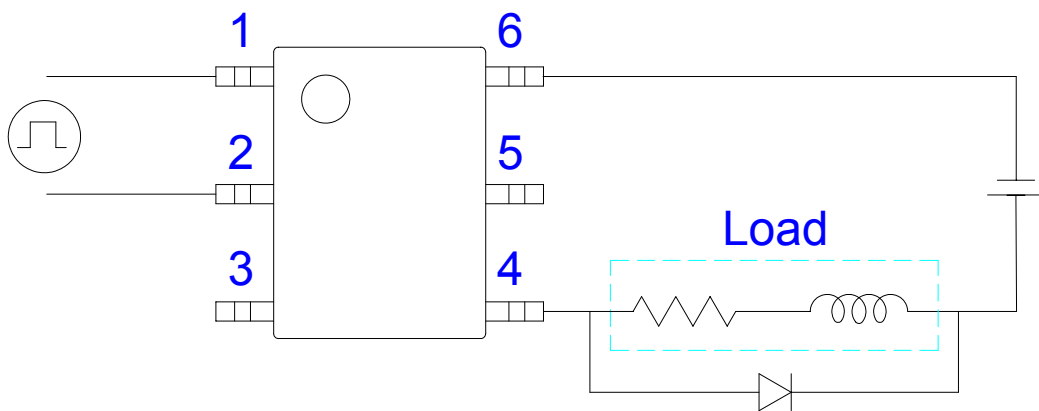

R-C Snubber