

# PRODUCT SPECIFICATION

DATE : 04/29/2011

<b>cosmo</b> ELECTRONICS CORPORATION	SOLID STATE RELAY - MOSFET OUTPUT <b>KAQV212</b>	NO.60M10013	REV. 3
		SHEET 1 OF 7	

## ● OUTSIDE DIMENSION :

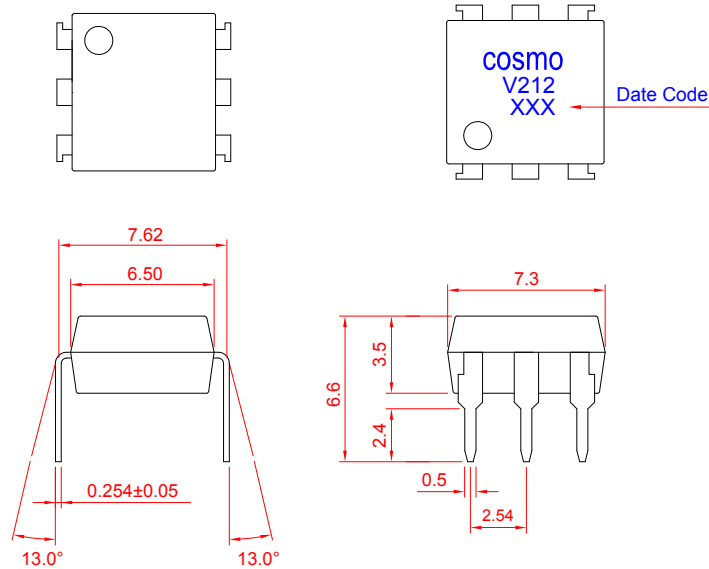

Unit : mm  
Tolerance : ±0.2mm

## ● Turn On / Turn Off time

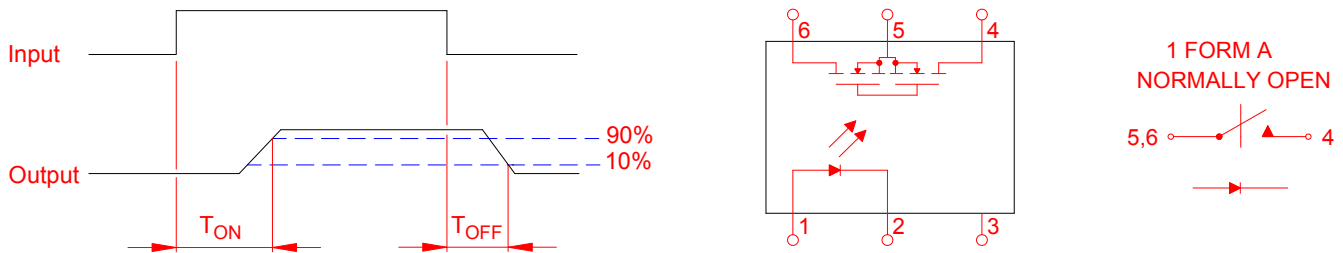

## ● Absolute Maximum Ratings

( Ta=25°C )

Emitter ( Input )	Detector ( Output )
Reverse Voltage ..... 5.0V	Output Breakdown Voltage ..... ± 60V
Continuous Forward Current ..... 50mA	Continuous Load Current ..... ± 400mA
Peak Forward Current ..... 1A	Power Dissipation ..... 500mW
Power Dissipation ..... 100mW	
Derate Linearly from 25°C ..... 1.3mW/°C	
General Characteristics	
Isolation Test Voltage ..... 3750VACrms	Storage Temperature Range ..... -40°C to +125°C
Isolation Resistance	Operating Temperature Range ... -40°C to +85°C
Vio=500V , Ta=25°C ..... ≥ 10 <sup>10</sup> Ω	Junction Temperature ..... 100°C
Total Power Dissipation ..... 550mW	Soldering Temperature ,
Derate Linearly from 25°C ..... 2.5mW/°C	2mm from case , 10 sec ..... 260°C

# PRODUCT SPECIFICATION

DATE : 04/29/2011

<b>cosmo</b> ELECTRONICS CORPORATION	SOLID STATE RELAY - MOSFET OUTPUT <b>KAQV212</b>	NO.60M10013	REV.
		SHEET 2 OF 7	3

## ● Electro-optical Characteristics

(Ta=25°C)

Parameter	Symbol	Conditions	Min.	Typ.	Max.	Unit.	
Emitter ( Input )							
Forward Voltage	$V_F$	$I_F=10\text{mA}$		1.2	1.5	V	
Operation Input Current	$I_{F\text{ON}}$	$V_L=\pm 20\text{V}$ , $I_L=100\text{mA}$ , $t=10\text{ms}$			5.0	mA	
Recovery Input Current	$I_{F\text{OFF}}$	$V_L=\pm 20\text{V}$ , $I_L \leq 5\mu\text{A}$	0.2			mA	
Detector ( Output )							
Output Breakdown Voltage	$V_B$	$I_B=50\mu\text{A}$	60			V	
Output Off-State Leakage	$I_{T\text{OFF}}$	$V_T=60\text{V}$ , $I_F=0\text{mA}$		0.2	1	$\mu\text{A}$	
I/O Capacitance	$C_{\text{ISO}}$	$I_F=0$ , $f=1\text{MHz}$		6		pF	
ON Resistance	Connection	A	$I_L=100\text{mA}$ , $I_F=10\text{mA}$		0.83	2.50	$\Omega$
		B			0.44	1.25	
		C			0.25	0.63	
Turn-On Time	$T_{\text{ON}}$	$I_F=10\text{mA}$ , $V_L=\pm 20\text{V}$		0.2	1.5	ms	
Turn-Off Time	$T_{\text{OFF}}$	$t=10\text{ms}$ , $I_L=\pm 100\text{mA}$		0.3	1.5	ms	

## ● Schematic and Wiring Diagrams

Schematic	Output Configuration	Load	Connection	Wiring Diagrams
	1a	AC/DC	A	
		DC	B	
		DC	C	

# PRODUCT SPECIFICATION

DATE : 04/29/2011

**cosmo**  
ELECTRONICS CORPORATION

SOLID STATE RELAY - MOSFET OUTPUT  
**KAQV212**

NO.60M10013  
SHEET 3 OF 7

REV.  
3

## ● Data Curve

Load current vs. ambient temperature  
Allowable ambient Temperature :  
-40°C to +85°C

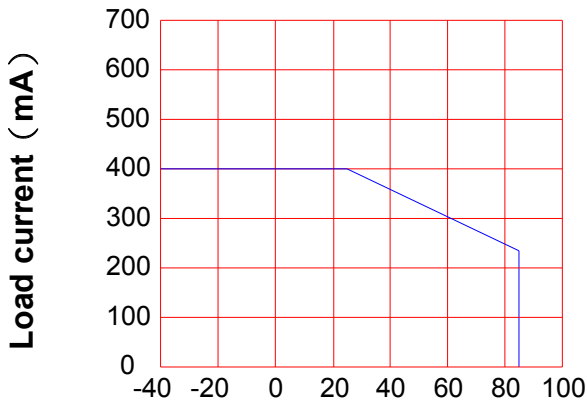

Ambient temperature Ta (°C)

On resistance vs. ambient temperature  
across terminals 4 and 6 pin  
LED current : 5mA  
Continuous load current : 400mA (DC)

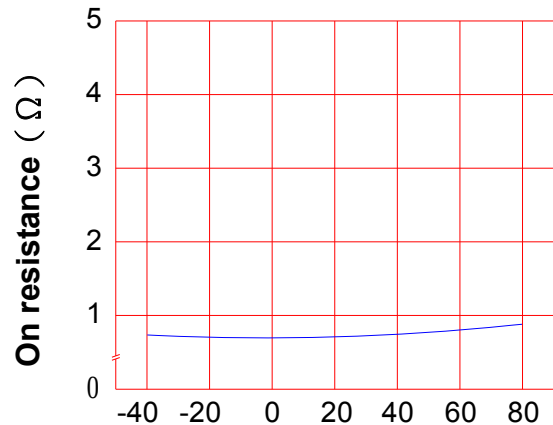

Ambient temperature Ta (°C)

Turn On Time vs. ambient temperature  
Load voltage 60V (DC)  
LED current : 5mA  
Continuous load current : 400mA (DC)

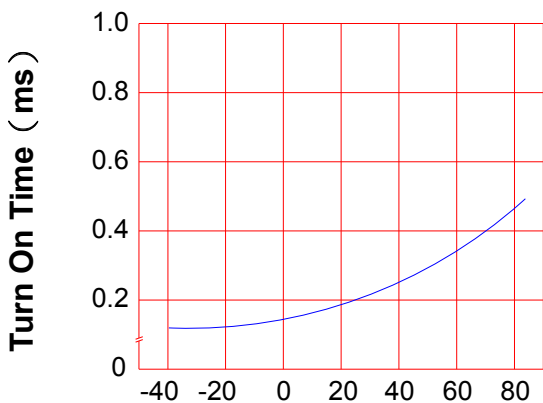

Ambient temperature Ta (°C)

Turn Off Time vs. ambient temperature  
Load voltage 60V (DC)  
LED current : 5mA  
Continuous load current : 400mA (DC)

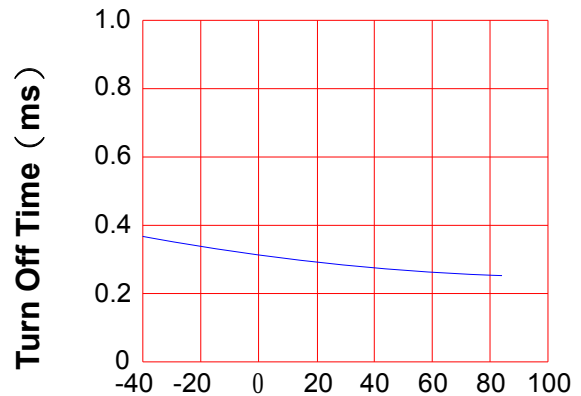

Ambient temperature Ta (°C)

# PRODUCT SPECIFICATION

DATE : 04/29/2011

**cosmo**  
ELECTRONICS CORPORATION

SOLID STATE RELAY - MOSFET OUTPUT  
**KAQV212**

NO.60M10013  
SHEET 4 OF 7

REV.  
3

LED operate current vs.  
ambient temperature

Load Voltage : 60V (DC)

Continuous load current : 400mA (DC)



Ambient temperature Ta (°C)

LED Turn Off current vs.  
ambient temperature

Load Voltage : 60V (DC)

Continuous load current : 400mA (DC)

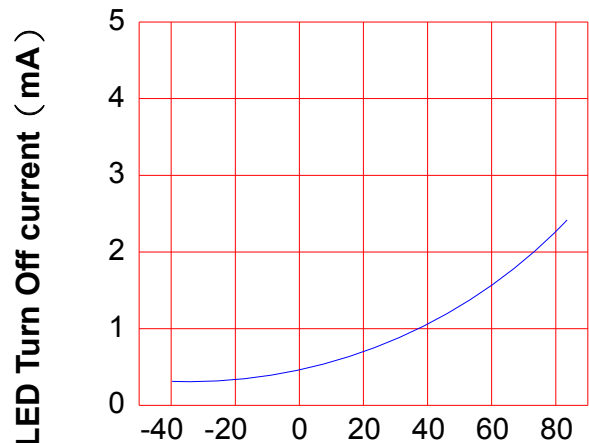

Ambient temperature Ta (°C)

LED dropout voltage vs.  
ambient temperature

LED current : 5 to 50mA

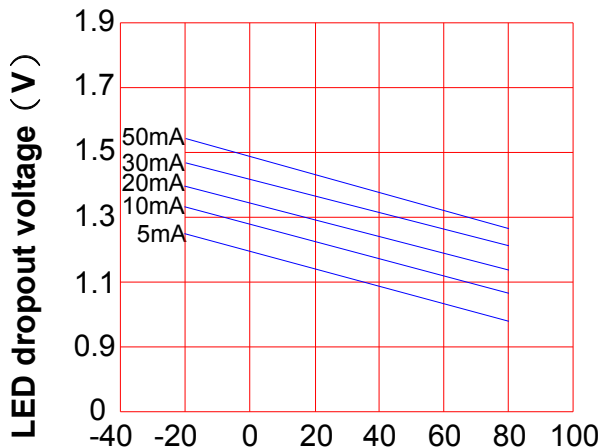

Ambient temperature Ta (°C)

Voltage vs. current characteristics  
of output at MOSFET portion

Measured portion : across terminals  
4 and 6 pin

Ambient temperature : 25°C

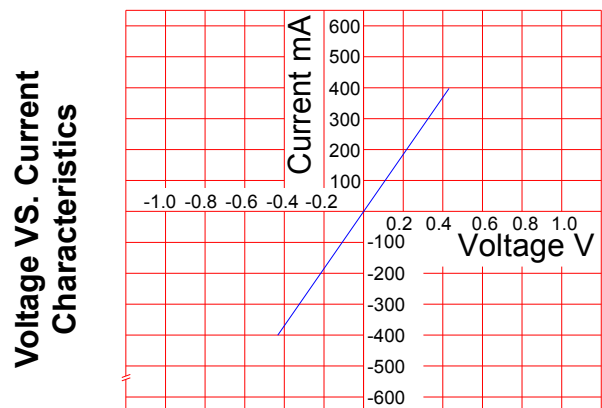

Ambient temperature : 25°C

# PRODUCT SPECIFICATION

DATE : 04/29/2011

**cosmo**  
ELECTRONICS CORPORATION

SOLID STATE RELAY - MOSFET OUTPUT  
**KAQV212**

NO.60M10013  
SHEET 5 OF 7

REV.  
3

## LED forward current vs. Turn On Time

Across terminals 4 and 6 pin

Load voltage : 60V (DC)

Continuous load current : 400mA (DC)

Ambient temperature : 25°C

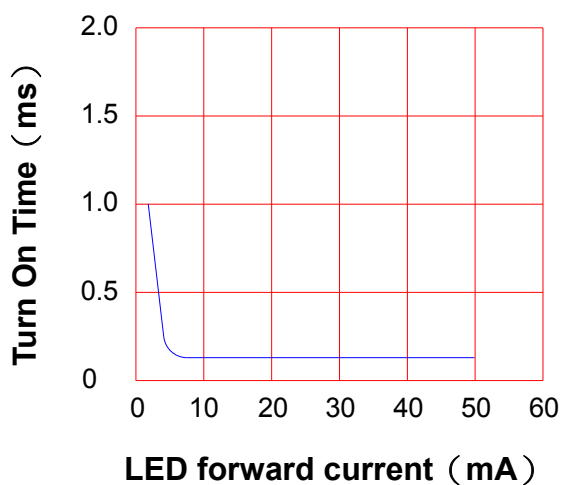

## Off state leakage current

Across terminals 4 and 6 pin

Ambient temperature : 25°C

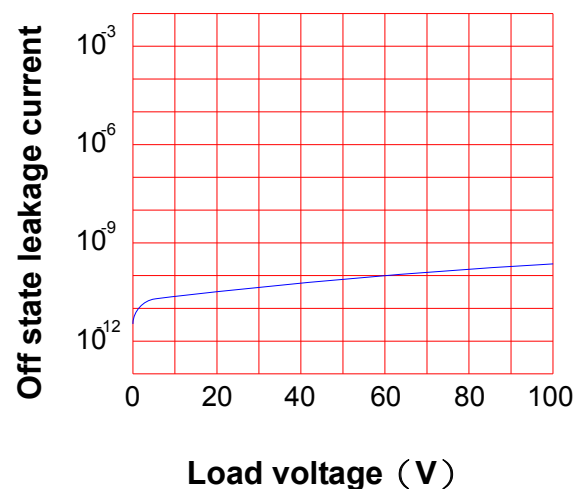

## LED forward current vs. reverse(ON) time

Across terminals 4 and 6 pin

Load voltage : 60V (DC)

Continuous load current : 400mA (DC)

Ambient temperature : 25°C

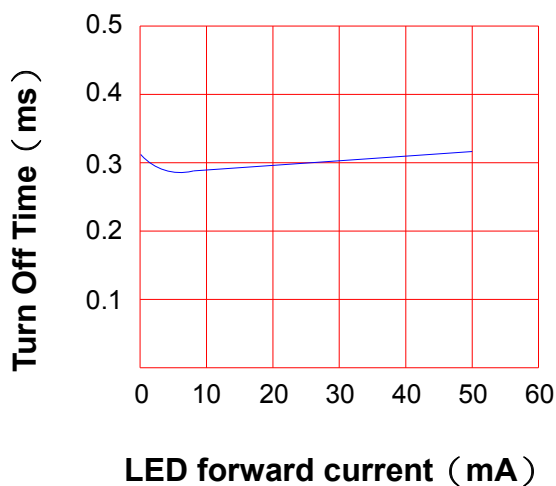

## Applied voltage vs. output capacitance

Across terminals 4 and 6 pin

Frequency : 1MHz

Ambient temperature : 25°C

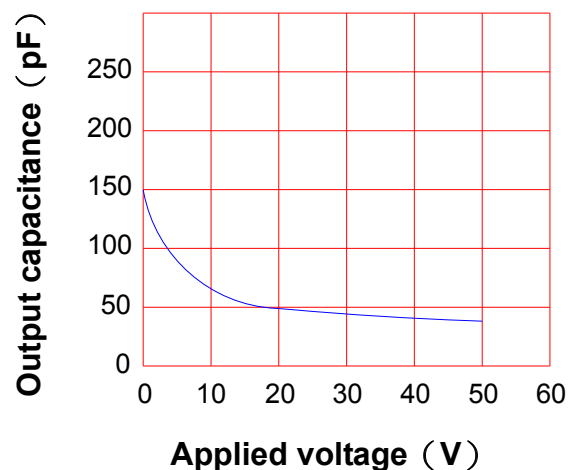

# PRODUCT SPECIFICATION

DATE : 04/29/2011

**cosmo**  
ELECTRONICS CORPORATION

SOLID STATE RELAY - MOSFET OUTPUT  
**KAQV212**

NO.60M10013  
SHEET 6 OF 7

REV.  
3

## ● USING METHODS

Examples of resistance value to control LED forward current ( $I_F$ )

SSR-MOSFET OUTPUT

( $I_F=5\text{mA}$ )

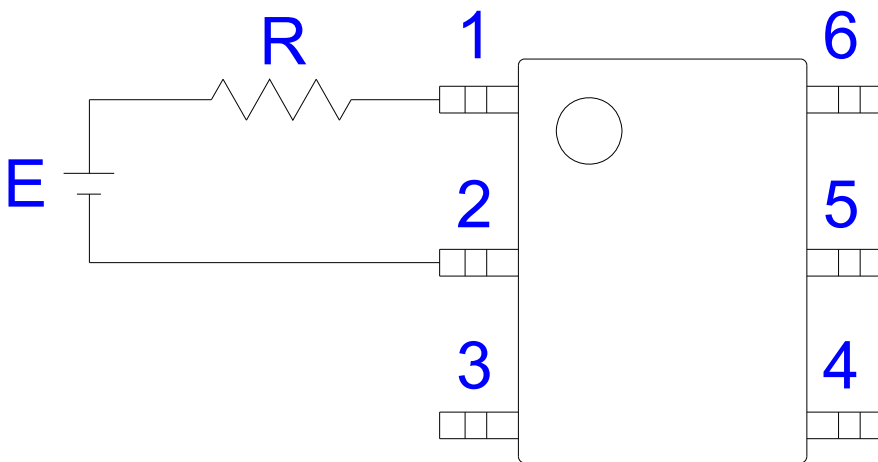

E	R
3.3V	Approx. 330 $\Omega$
5V	Approx. 640 $\Omega$
12V	Approx. 1.9K $\Omega$
15V	Approx. 2.5K $\Omega$
24V	Approx. 4.1K $\Omega$

- (1) LED forward current must be more than 5mA , at E min.
- (2) LED forward current must be less than 50mA , at E max.

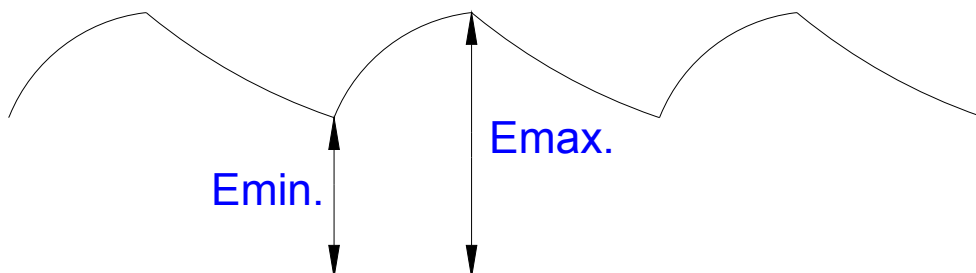

# PRODUCT SPECIFICATION

DATE : 04/29/2011

**cosmo**  
ELECTRONICS CORPORATION

SOLID STATE RELAY - MOSFET OUTPUT  
**KAQV212**

NO.60M10013  
SHEET 7 OF 7

REV.  
3

## ● USING METHODS

Regulate the spike voltage generated on the inductive load as follows :

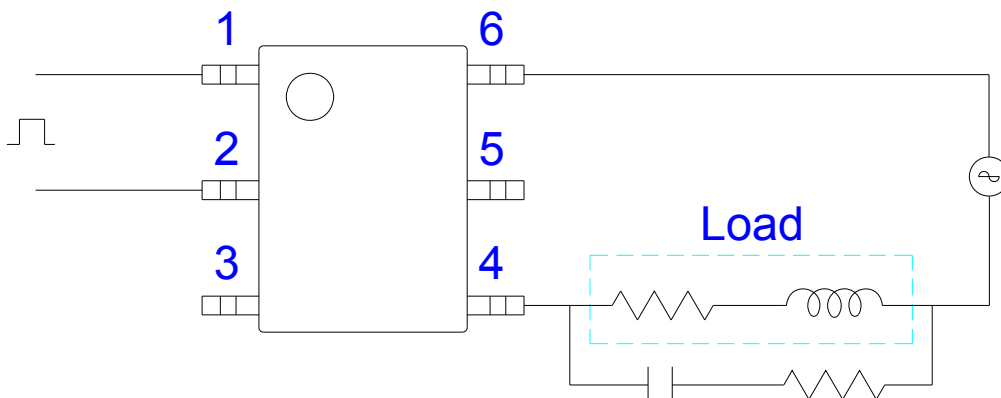
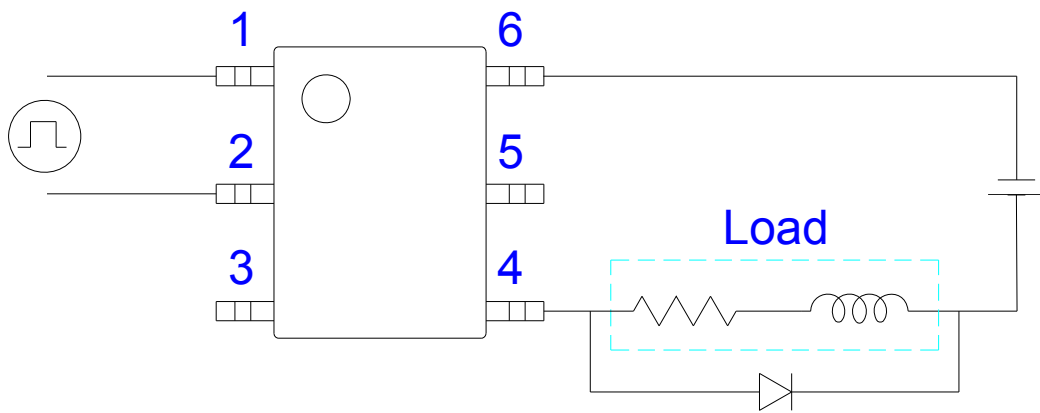

R-C Snubber