

APPROVAL SHEET

DATE: 11/29/2007

cosmo ELECTRONICS CORPORATION	Photolink :	NO.60F20003	REV.
	KPLT5000M40	SHEET 1 OF 4	1

FIBER OPTIC TRANSMITTING MODULE FOR DIGITAL AUDIO EQUIPMENT

Features

- TTL interface.
- LED is driven by differential circuit.
- A Self-tapping hole for easy attachment to audio Equipment panels.

Applications

- Audio equipment.
- DVD player.
- Automobile.

Outline Dimensions

(Unit:mm)

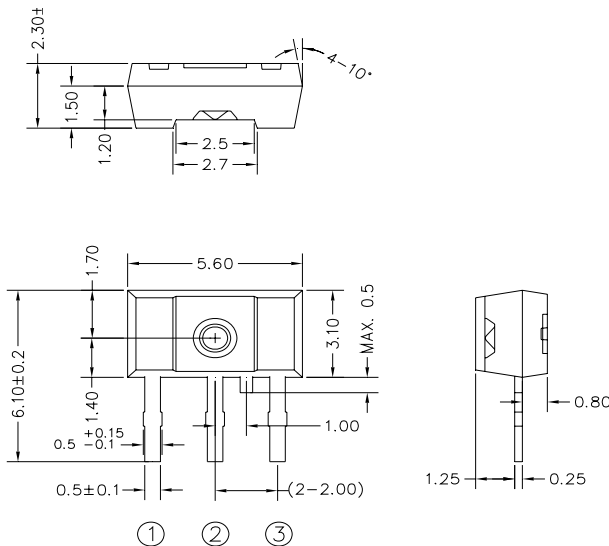

注1. 無指定尺寸公差部分: ±0.2mm

Note1. General dimensions tolerance: ±0.2mm

注2. 無指定角度公差部分: ±3°

Note2. General angle tolerance: ±3°

注3. 無指定Corner R: Max 0.4mm

Note3. General corner: Max 0.4mm

Pin Connection

1. Vin
2. Vcc
3. GND

APPROVAL SHEET

DATE: 11/29/2007

cosmo ELECTRONICS CORPORATION	Photolink :	NO.60F20003	REV.
	KPLT5000M40	SHEET 2 OF 4	1

1. Maximum Ratings (Ta=25°C)

Parameter	Symbol	Rating	Unit
Storage Temperature	T _{stg}	-40~+85	°C
Operating Temperature	T _{opr}	-30~+80	°C
Power Dissipation	P _{max}	120	mW
Supply Voltage	V _{CC}	-0.5~7	V
Input Voltage	V _{IN}	-0.5~V _{CC} +0.5	V
Soldering Temperature	T _{sol}	260 ^(Note 1)	°C

Note 1 : Soldering time \leq 10 seconds (At a distance of 1 mm from the package) .

2. Recommended Operating Conditions

Parameter	Symbol	Min	Typ.	Max	Unit
Supply Voltage	V _{CC}	2.70	5.0	5.5	V
High-Level Input Voltage	V _{IH}	2.0	-	V _{CC}	V
Low-Level Input Voltage	V _{IL}	0	-	0.8	V

3. Electrical and Optical Characteristics (Ta=25°C , V_{CC}=5V)

Parameter	Symbol	Condition	Min	Typ.	Max	Unit
Data Rate		NRZ Signal ^(Note 2)	DC	-	50	Mb/s
Fiber Output Power ^(Note 3)	P _f		-21	-	-15	dBm
Peak Emission Wavelength	λ_p		630	-	690	nm
Current Consumption	I _{CC}		-	5	8	mA
High Level Input Voltage	V _{IH}		2.0	-	-	V
Low Level Input Voltage	V _{IL}		-	-	0.8	V
Low->High Propagation delay time	t _{PLH}				50	ns
High -> Low Propagation delay time	t _{PHL}				50	ns
Pulse Width Distortion	Δtw	25Mbps NRZ Signal	-6	-	6	ns
Jitter Time	Δtj				10	ns

Note 2 : LED is on when input signal is high, and off when it is low.

The duty factor must be maintained between 25 to 75%.

Note 3 : Measure with a standard optical fiber, peak value.

APPROVAL SHEET

DATE: 11/29/2007

cosmo ELECTRONICS CORPORATION	Photolink : KPLT5000M40	NO.60F20003 SHEET 3 OF 4	REV. 1

4. Measuring method

(1). Measuring method of optical output coupling fiber

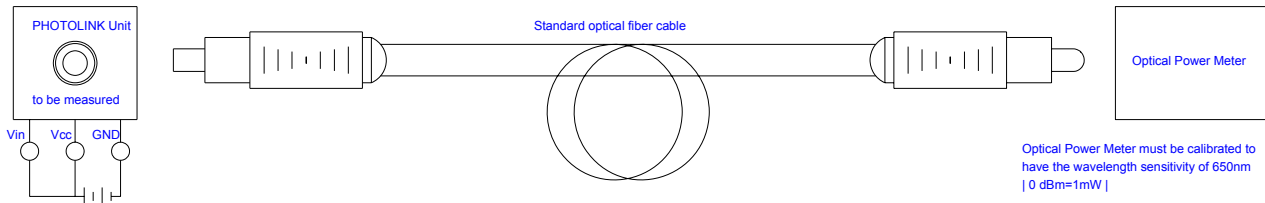

(2). Measuring method of power dissipation current and input voltage

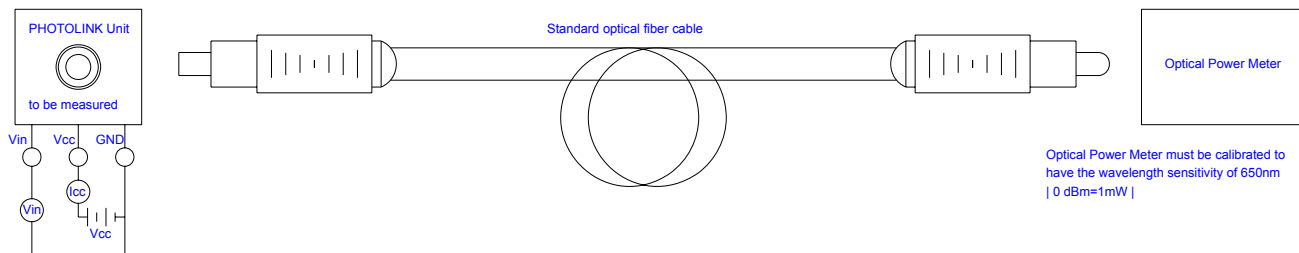

(3). Measuring method of Pulse response

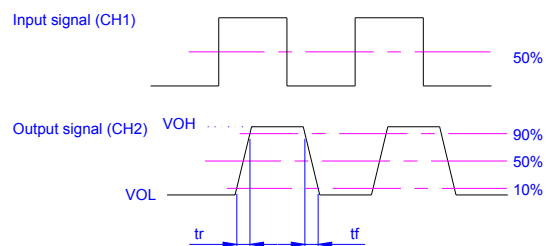
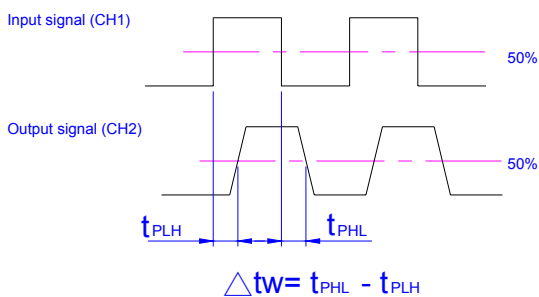
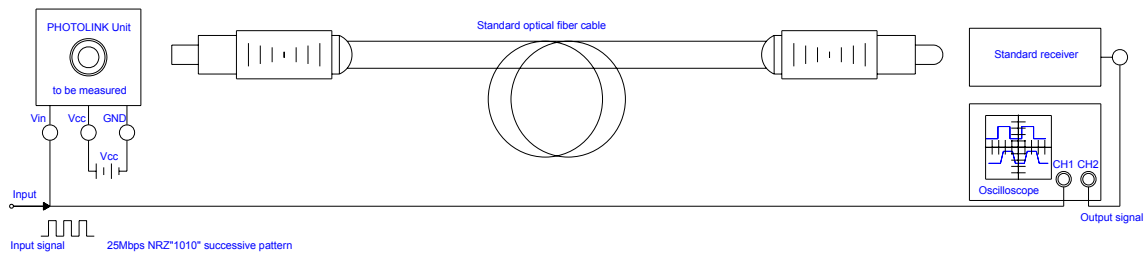

APPROVAL SHEET

DATE: 11/29/2007

cosmo ELECTRONICS CORPORATION	Photolink : KPLT5000M40	NO.60F20003	REV.
		SHEET 4 OF 4	1

(4).Measuring method of Jitter

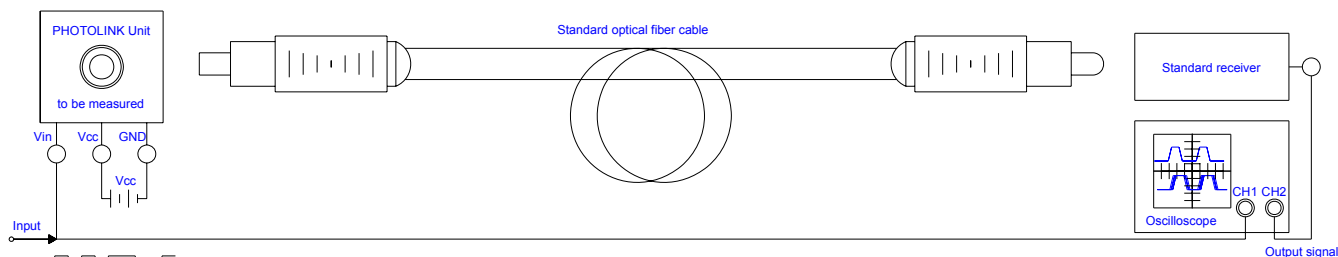

Input signal (CH1)

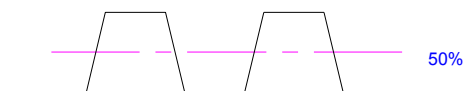

Output signal (CH2)

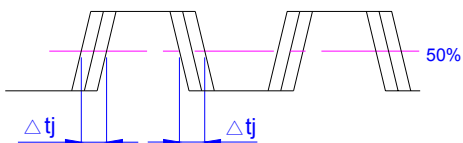

5.Recommended PCB Layout

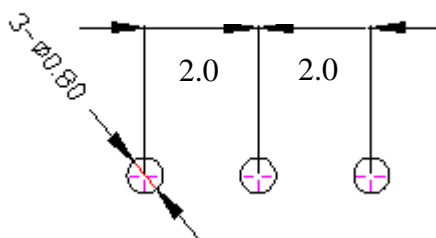

Notes:

1.Unit:mm

2.tolerance:±0.3mm