

## ● Description

The KTLP168J series consist of a GaAs infrared emitting diode optically coupled to a monolithic silicon detector performing the function of a zero voltage crossing bilateral TRIAC driver. They are designed for use with a TRIAC in the interface of logic systems to equipment powered from 115/240 VAC lines, such as solid-state relays, industrial controls, motors, solenoids and consumer appliances, etc.

## ● Features

1. Pb free and RoHS compliant.
2. 600V peak blocking voltage
3. Subminiature type (The volume is smaller than that of our conventional DIP type by as far as 30%)
4. Simplifies logic control of 115/240 VAC power
5. Zero voltage crossing
6. Isolation voltage between input and output (Viso : 3750Vms)
7. Agency Approvals :
  - UL1577, File No. E169586
  - CUL C22.2 No.1 & NTC No.5, File No. E169586
  - VDE EN60747-5-2, File No. 40009235
  - CQC GB4943/GB8898-2011, File No. CQC10001049555 / CQC08001023986

## ● Applications

- Solenoid/Valve controls
- Lighting controls
- Static power switches
- AC motor drives
- Temperature controls
- E.M contactors
- AC motor contactors
- Solid state relay
- Programmable controllers

## ● Schematic

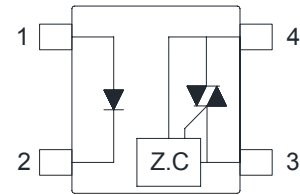

1. Anode
2. Cathode
3. Main terminal
4. Main terminal

● **Outside Dimension**

Unit : mm

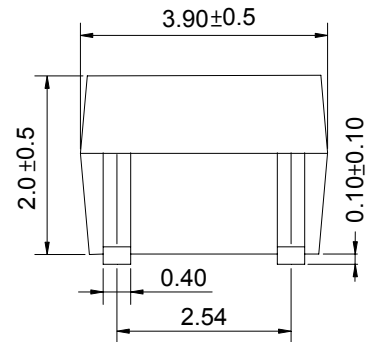
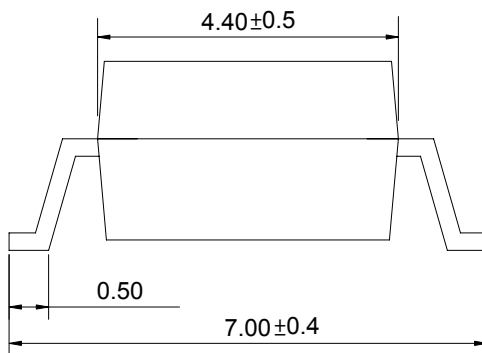
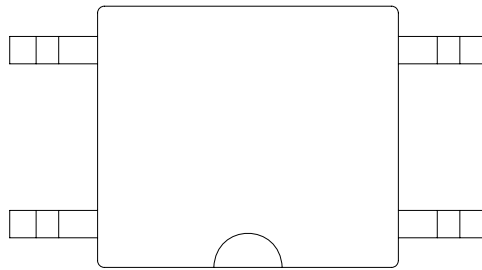

TOLERANCE : ±0.2mm

● **Device Marking**



**Notes :**

**COSMO**

**168J**

**YWW**

Y : Year code / W : Week code

### ● Absolute Maximum Ratings

(Ta=25°C)

Parameter		Symbol	Rating	Unit
Input	Forward current	$I_F$	50	mA
	Peak forward current	$I_{FM}$	1	A
	Reverse voltage	$V_R$	6	V
	Power dissipation	$P_D$	70	mW
Output	Off-state output terminal voltage	$V_{DRM}$	600	$V_{PEAK}$
	On-state R.M.S. current	$I_{T(RMS)}$	70	mA
	Peak repetitive surge current (PW=10ms.DC 10%)	$I_{TSM}$	1	A
	Power dissipation	$P_D$	150	mW
Total power dissipation		$P_{tot}$	200	mW
Isolation voltage 1 minute		$V_{iso}$	3750	Vrms
Operating temperature		$T_{opr}$	-40 to +115	°C
Storage temperature		$T_{stg}$	-50 to +125	°C
Soldering temperature 10 seconds		$T_{sol}$	260	°C

### ● Electro-optical Characteristics

(Ta=25°C)

Parameter		Symbol	Conditions	Min.	Typ.	Max.	Unit
Input	Forward voltage	$V_F$	$I_F=10mA$	-	1.2	1.4	V
	Reverse current	$I_R$	$V_R=4V$	-	-	10	$\mu A$
Output	Peak blocking current	$I_{DRM}$	$V_{DRM}$ Rated	-	-	1	$\mu A$
	On-state voltage	$V_{TM}$	$I_{TM}=70mA$	-	1.8	3	V
Transfer characteristics	Holding current	$I_H$		-	0.1	-	mA
	Critical rate of rise of off-state voltage	dv/dt	$V_{DRM}=(1/\sqrt{2}) * \text{Rated}$	1000	-	-	V/ $\mu s$
	Inhibit voltage (MT1-MT2 voltage above which device will not trigger)	$V_{INH}$	$I_F = \text{Rated } I_{FT}$	-	-	20	V
	Leakage in inhibited state	$I_{DRM2}$	$I_F = \text{Rated } I_{FT}, \text{ Rated } V_{DRM}, \text{ Off-state}$	-	-	600	$\mu A$
	Isolation resistance	$R_{iso}$	DC500V	$5 \times 10^{10}$	$10^{11}$	-	$\Omega$
	Minimum trigger current	$I_{FT}$	Main terminal voltage=3V	-	-	3	mA

### ● Static dv/dt Test Circuit

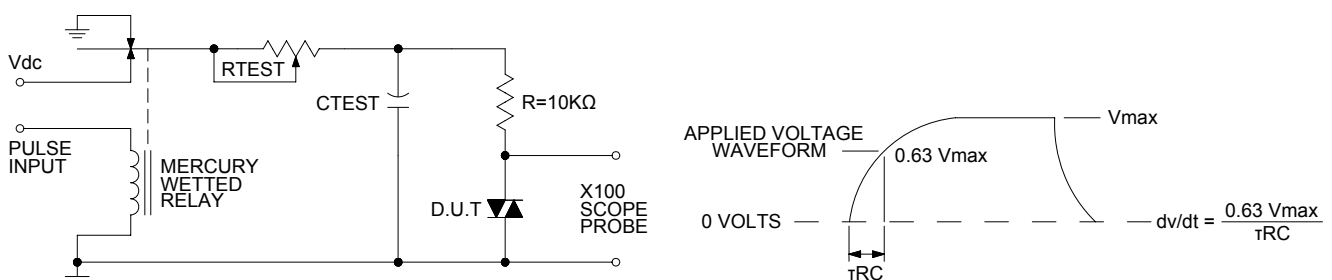

**Fig.1 Forward Current vs. Ambient Temperature**

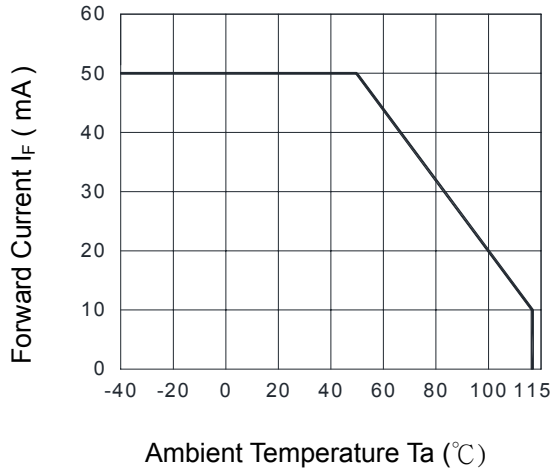

**Fig.2 Diode Power Dissipation vs. Ambient Temperature**

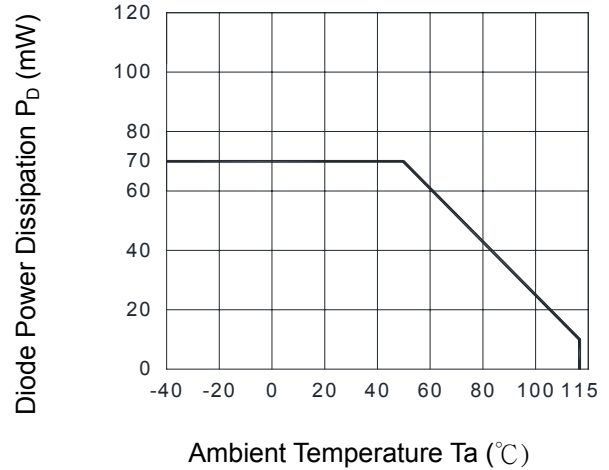

**Fig.3 On-state R.M.S. Current vs. Ambient Temperature**

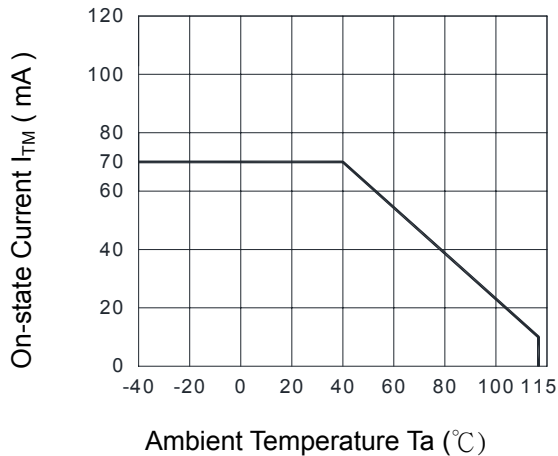

**Fig.4 Total Power Dissipation vs. Ambient Temperature**

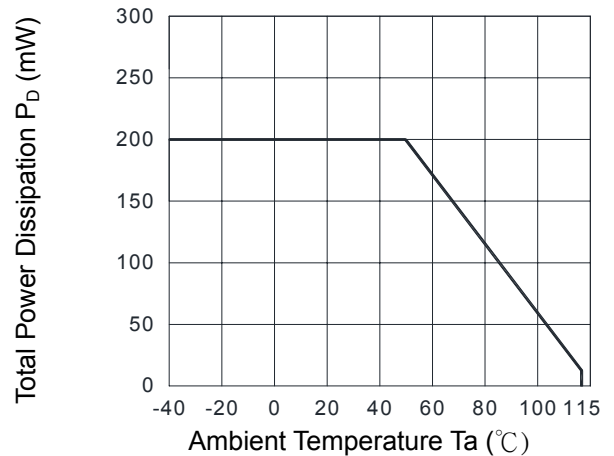

**Fig.5 Peak Forward Current vs. Duty Ratio**

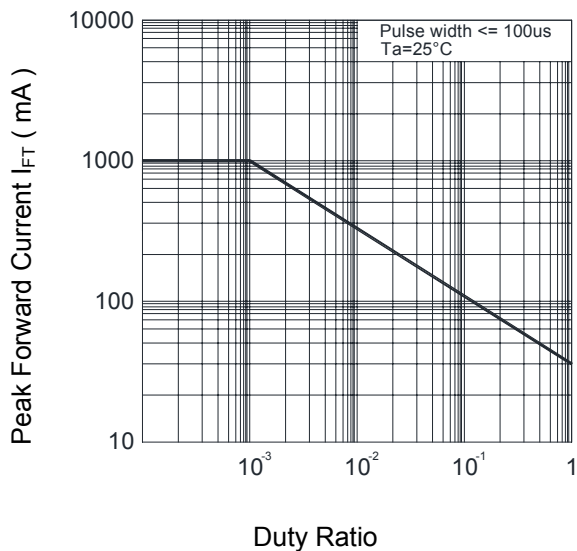

**Fig.6 Forward Current vs. Forward Voltage**

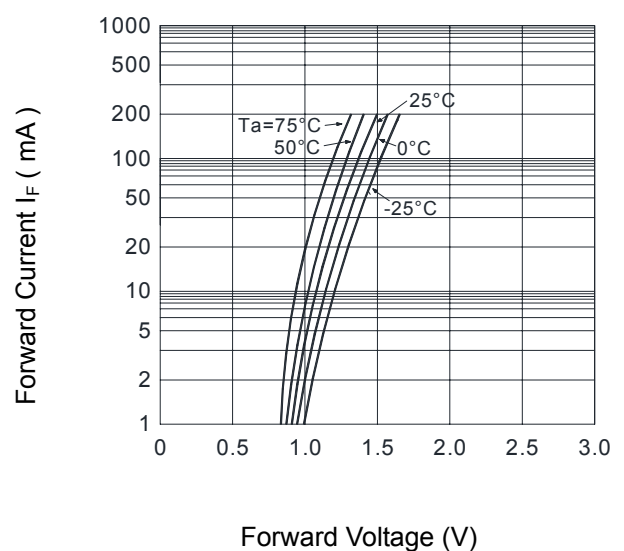

**Fig.7 On-state Characteristics**

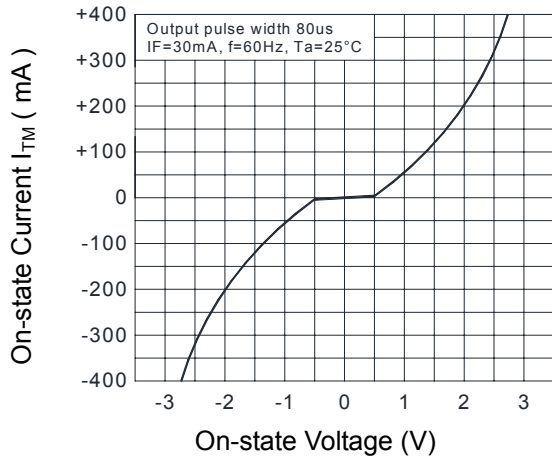

**Fig.8 Inhibit Voltage vs. Ambient Temperature**

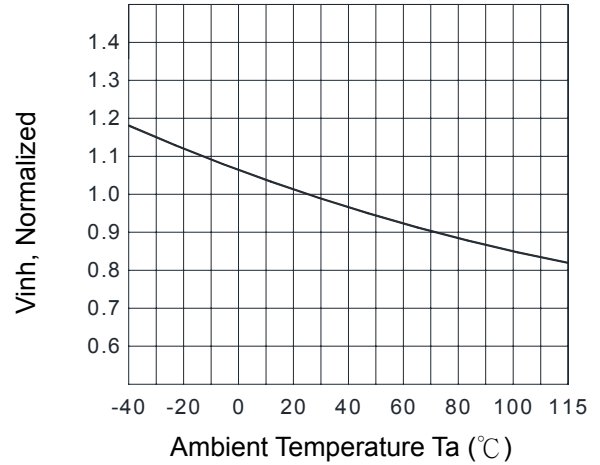

**Fig.9 Leakage with LED off vs. Ambient Temperature**

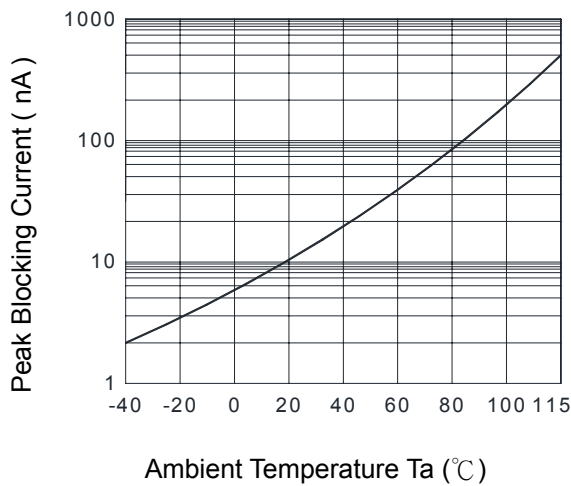

**Fig.10 I\_DRM2, Leakage in Inhibited State vs. Ambient Temperature**

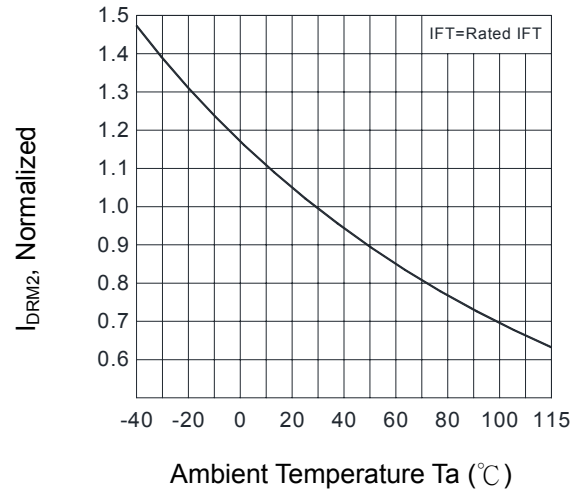

**Fig.11 Trigger Current vs. Ambient Temperature**

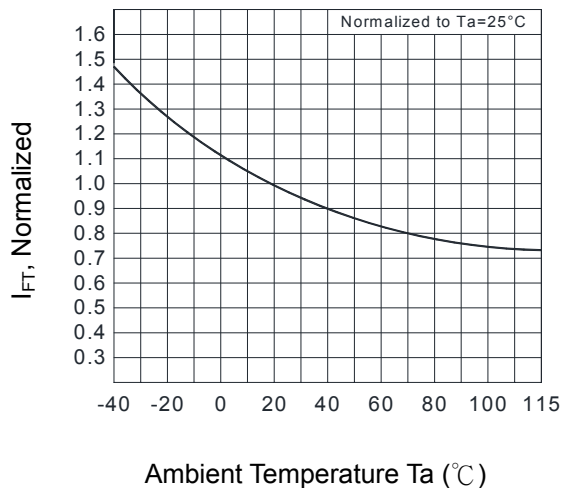

### ● Recommended Soldering Conditions

#### (a) Infrared reflow soldering :

- Peak reflow soldering : 260°C or below (package surface temperature)
- Time of peak reflow temperature : 10 sec
- Time of temperature higher than 230°C : 30-60 sec
- Time to preheat temperature from 180~190°C : 60-120 sec
- Time(s) of reflow : Two
- Flux : Rosin flux containing small amount of chlorine (The flux with a maximum chlorine content of 0.2 Wt% is recommended.)

#### Recommended Temperature Profile of Infrared Reflow

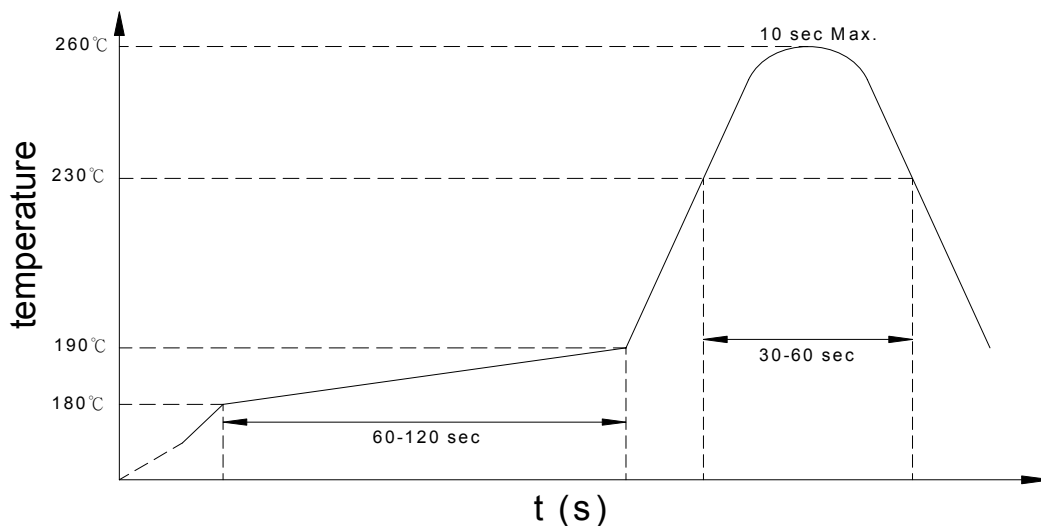

#### (b) Wave soldering :

- Temperature : 260°C or below (molten solder temperature)
- Time : 10 seconds or less
- Preheating conditions : 120°C or below (package surface temperature)
- Time(s) of reflow : One
- Flux : Rosin flux containing small amount of chlorine (The flux with a maximum chlorine content of 0.2 Wt% is recommended.)

#### (c) Cautions :

- Fluxes : Avoid removing the residual flux with freon-based and chlorine-based cleaning solvent.
- Avoid shorting between portion of frame and leads.

- **Numbering System**

## KTLP168J ( X )

**Notes :**

KTLP168J = Part No.

X = Tape and reel option ( TLD · TRU )

Option	Description	Packing quantity
TLD	surface mount type package + TLD tape & reel option	3000 units per reel
TRU	surface mount type package + TRU tape & reel option	3000 units per reel

- **Recommended Pad Layout for Surface Mount Lead Form**

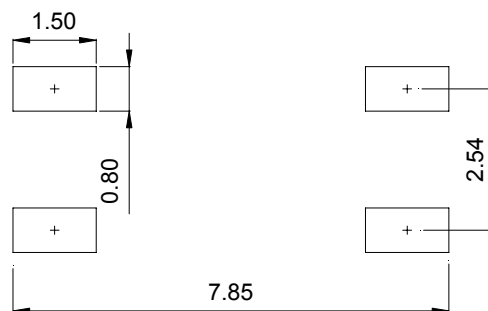
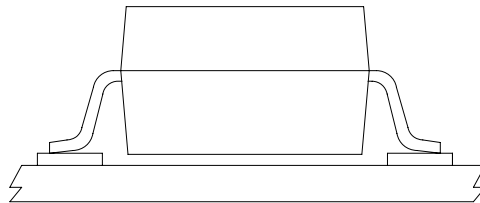

Unit : mm

● 4-pin Mini-Flat TLD/TRU Carrier Tape & Reel

Unit : mm

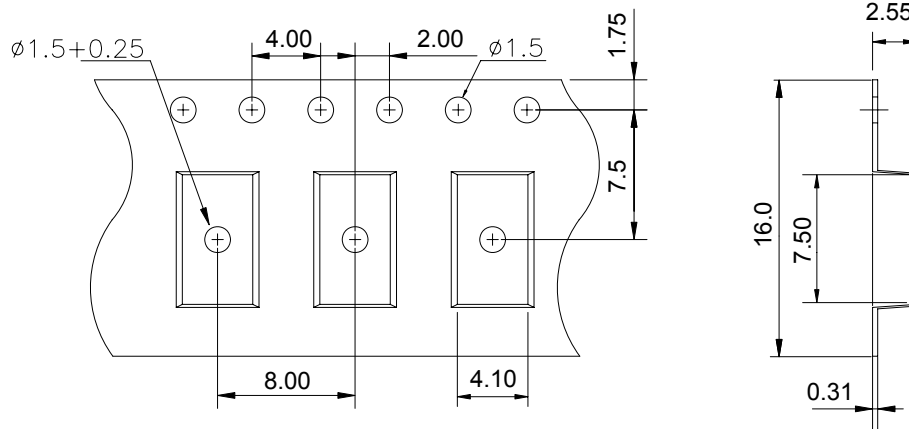

TOLERANCE :  $\pm 0.2\text{mm}$

TLD

TRU

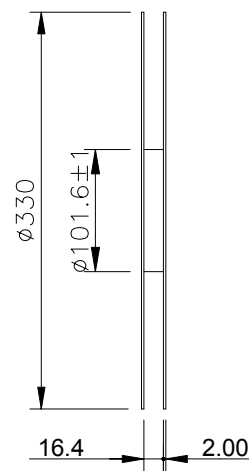
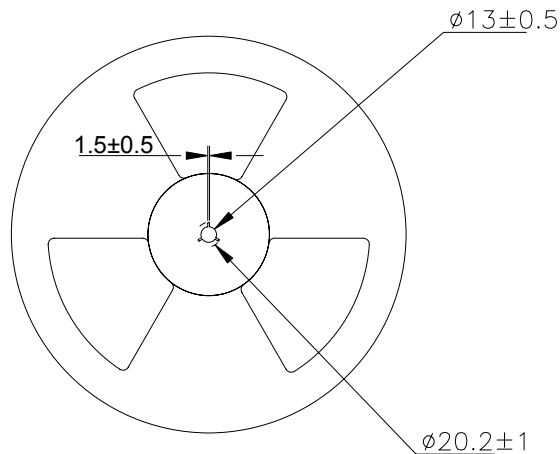
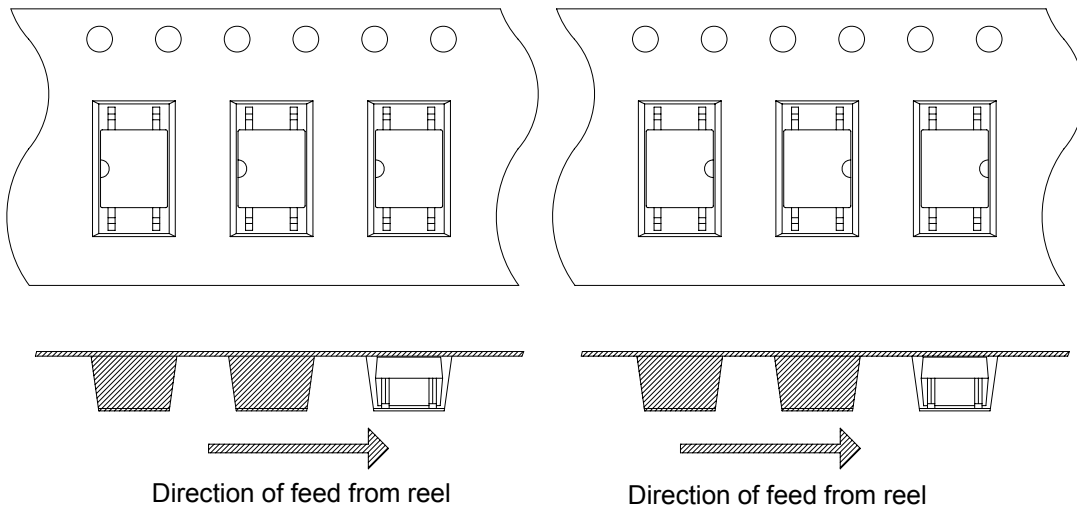



# KTLP168J Series

## 4PIN MINI-FLAT ZERO-CROSS TRIAC DRIVER PHOTOCOUPLER

---

### ● Application Notice

The content of datasheet is the guidance for product use only. cosmo takes no responsibility to the accuracy of the information provided here. For continuously improving all of products, including quality, reliability, function...etc., cosmo reserves the right to change the specification, characteristics, data, materials, and structure of products without notice. Please contact with cosmo to obtain the latest specification.

It would be required to comply with the absolute maximum ratings listed in the specification. cosmo has no liability and responsibility to the damage caused by improper use of the products.

cosmo products are intended to be designed for use in general electronics application list below:

- a. Personal computer
- b. OA machine
- c. Audio / Video
- d. Instrumentation
- e. Electrical application
- f. Measurement equipment
- g. Consumer electronics
- h. Telecommunication

cosmo devices shall not be used or related with equipment requiring higher level of quality / reliability, or malfunction, or failure which may cause loss of human life, bodily injury, includes, without limitation:

- a. Medical and other life supporting equipments
- b. Space application
- c. Telecommunication equipment (trunk lines)
- d. Nuclear power control
- e. Equipment used for automotive vehicles, trains, ships...etc.

This publication is the property of cosmo. No part of this publication may be reproduced or copied in any form or any means electronically or mechanically for any purpose, in whole or in part without any written permission expressed from cosmo.