

ML6206S Series Low ESR Cap. Compatible Positive Voltage Regulator

❖ *Application*

- ◆ *Battery Powered Equipment*
- ◆ *Palmtops*
- ◆ *Portable Cameras and Video Recorders*
- ◆ *Reference Voltage Sources*

❖ *Features*

- CMOS Low Power Consumption :
Typical 1.0uA at $V_{out}=3.0V$
- Output Voltage Range : 1.5V to 5.0V in 0.1V increments
- Highly Accurate:
Output Voltage $\pm 3\%$ for 1.5V to 1.9V
Output Voltage $\pm 2\%$ for 2.0V to 5.0V
- Maximum Output Current: 250mA
(within the maximum power dissipation, $V_{out}=5.0V$)
- Small Input-Output Voltage Differential:
0.16V at 100mA and 0.4V at 200mA
- Input stability: Typ. 0.2%/V
- Package Available:
SOT-23 (250mW), SOT-89 (500mW) &
TO-92 (300mW)
- Reverse Battery Protection

❖ *General Description*

The ML6206S series are highly precise, low power consumption, high voltage, positive voltage output, three-pin regulator. It provides high output current even when the input/output voltage differential is small.

The ML6206S consists of a high-precision voltage reference, an error correction circuit and reverse battery protection.

❖ *Block Diagram*

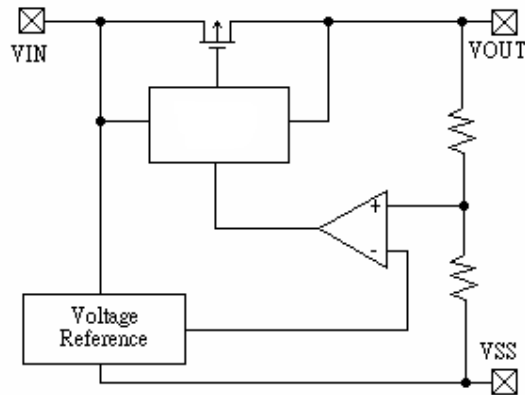

Absolute Maximum Ratings

Parameter		Symbol	Ratings	Units
Input Voltage		V_{IN}	6	V
Output Current		I_{OUT}	500	mA
Output Voltage		V_{OUT}	$V_{SS}-0.3 \sim V_{IN}+0.3$	V
Continuous Total Power Dissipation	SOT-23	P_d	250	mW
	SOT-89		500	
	TO-92		300	
Operating Ambient Temperature		T_{opr}	-40 ~ +70	°C
Storage Temperature		T_{stg}	-40 ~ +70	°C

❖ *Pin Configuration*

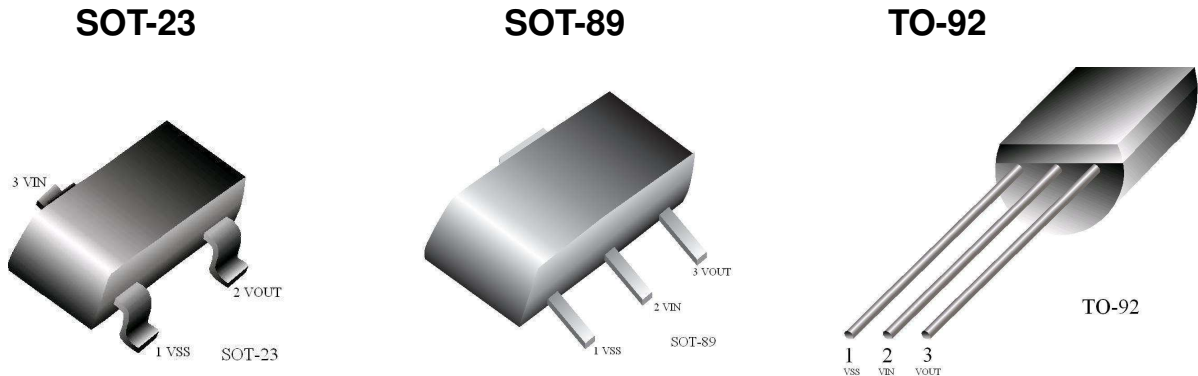

Package Pin Number			Pin Name	Function
SOT23	SOT89	TO-92		
1	1	1	VSS	Ground
3	2	2	VIN	Power Input
2	3	3	VOUT	Output

❖ *Standard Circuit*

Note on Use

- Oscillation may occur as a result of the impedance present between the power supply and the IC's input. Please use a capacitor (CIN) of at least 1uF, when the impedance is 10 ohm or more.
With a large output current, Voltage output can be stabilised by increasing capacitor (CIN) size. If CIN is small and capacitor (CL) size is increased, oscillation may occur. In such cases, Voltage output can be stabilised by either increasing the size of CIN or decreasing the size of CL.
- Please ensure that output current (IOUT) is less than $Pd / (VIN - VOUT)$ and does not exceed the stipulated Continuous Total Power Dissipation value (Pd).

❖ *Test Circuit*

Test Circuit 1

Test Circuit 2

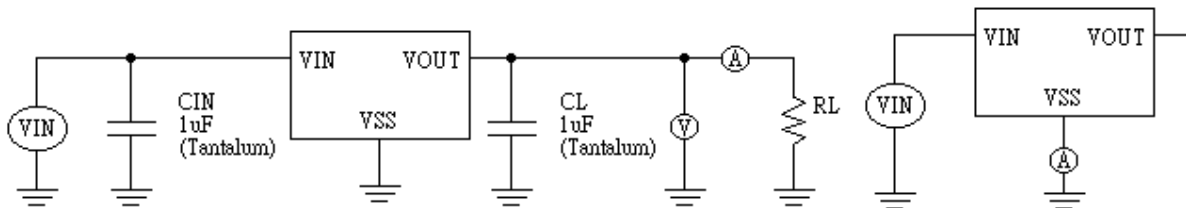



❖ *Electrical Characteristic*

ML6206S302 $V_{OUT}(T)=3.0V$ (Note 1)

Parameter	Symbol	Conditions	Min	Typ	Max	Units	Circuit
Output Voltage	$V_{OUT}(E)$ (Note 2)	$I_{OUT}=40mA$ $V_{IN}=4.0V$	2.940	3.000	3.060	V	1
Maximum Output Current	$I_{OUT\ max}$	$V_{IN}=4.0V, V_{OUT}(E) \geq 2.7V$	350			mA	1
Load Stability	ΔV_{OUT}	$V_{IN}=4.0V, 1mA \leq I_{OUT} \leq 100mA$		25		mV	1
Input –Output Voltage Differential (Note 3)	V_{dif1}	$I_{OUT}=80mA$		80		mV	1
	V_{dif2}	$I_{OUT}=150mA$		250		mV	1
Supply Current	I_{SS}	$V_{IN}=4.0V$		1.0		μA	2
Input Stability	$\frac{\Delta V_{OUT}}{\Delta V_{IN} * V_{OUT}}$	$I_{OUT}=40mA$ $V_{OUT}(T)+1.0V \leq V_{IN} \leq 6V$		0.01	0.30	%V	1
Input Voltage	V_{IN}		1.8		6	V	-
Current Limiter	I_{short}	$V_{IN} = V_{OUT}+1.5V, V_{OUT}=V_{SS}$		100		mA	1

Note : 1. $V_{OUT}(T)$ = Specified Output Voltage.

2. $V_{OUT}(E)$ = Effective Output Voltage (i.e. the output voltage when $(V_{OUT}(T)+1.0V)$ is provided at the V_{IN} pin while maintaining a certain I_{OUT} value).
3. V_{dif} = $V_{IN1}(\text{Note 4}) - V_{OUT}(E)$
4. V_{IN1} = The input voltage at the time 98% of $V_{OUT}(E)$ is output (input voltage has been gradually reduced).

❖ *Typical Performance Characteristics*

1) Output Voltage vs. Output Current

ML6206S153

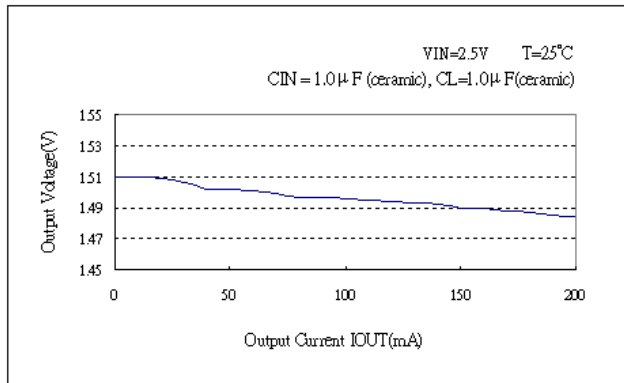

ML6206S302

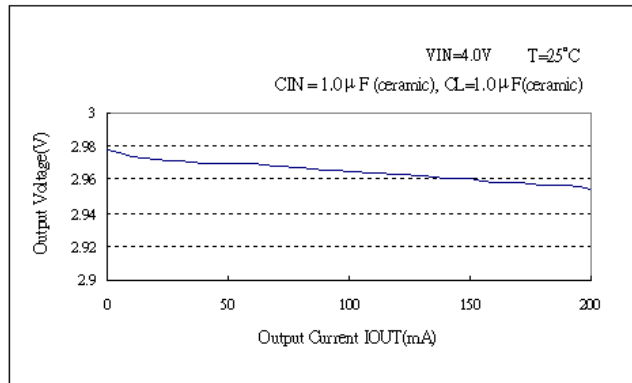

2) Current Limit

ML6206S153

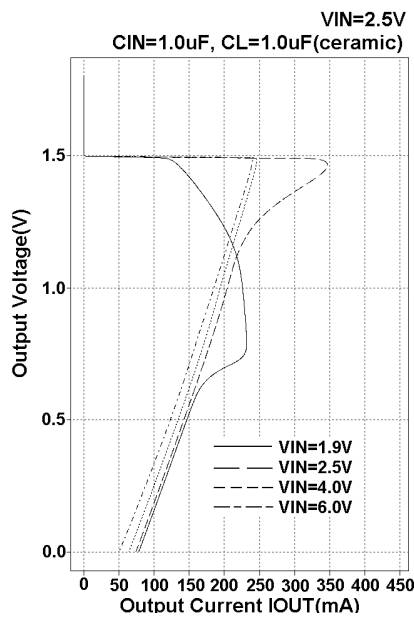

ML6206S302

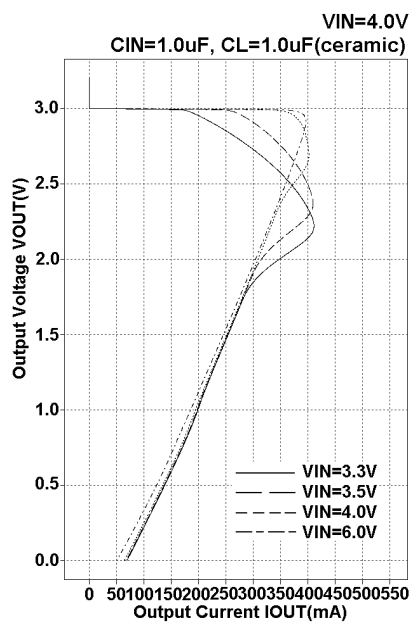

ML6206S502

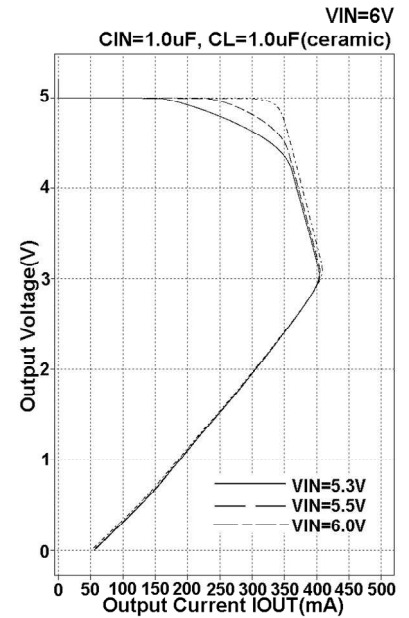



3) Output Voltage vs. Input Voltage

ML6206S153

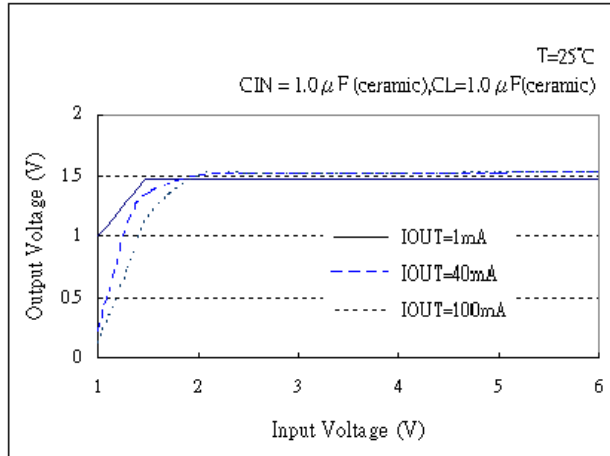

ML6206S302

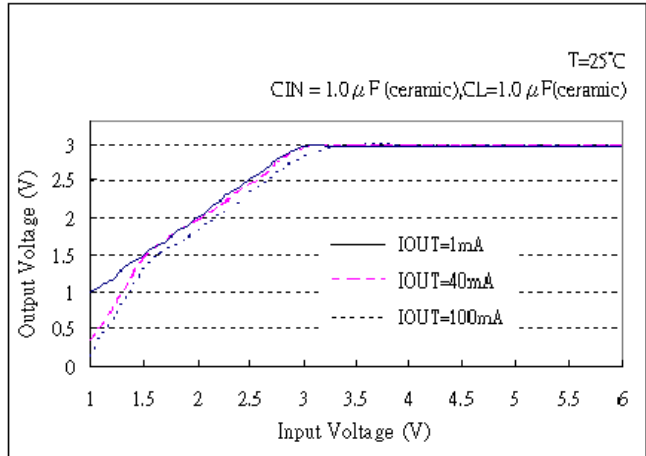

4) Supply Current vs. Input Voltage

ML6206S153

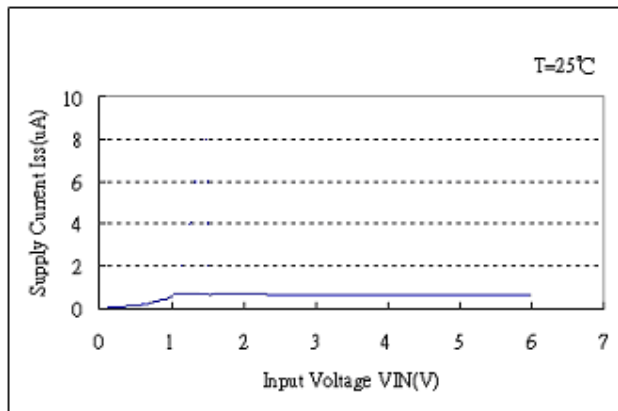

ML6206S302

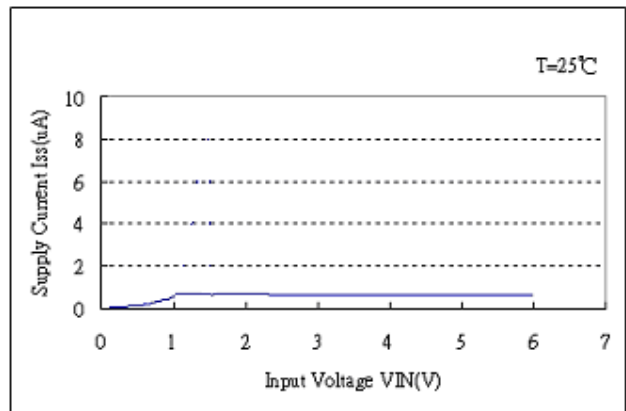

5) Output Voltage vs. Ambient Temperature

ML6206S153

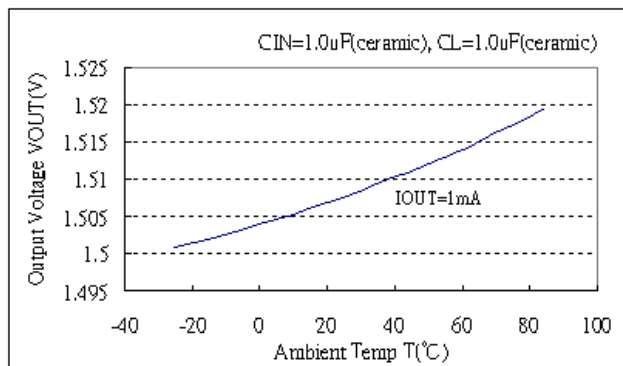

ML6206S302

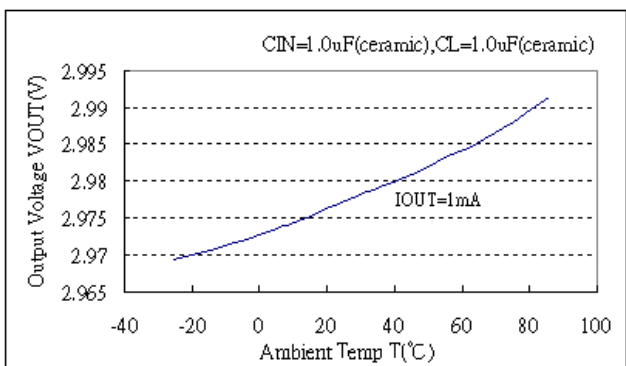



6) Supply Current vs. Ambient Temperature

ML6206S153

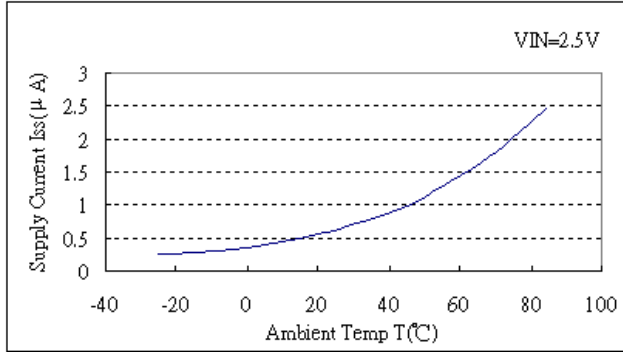

ML6206S302

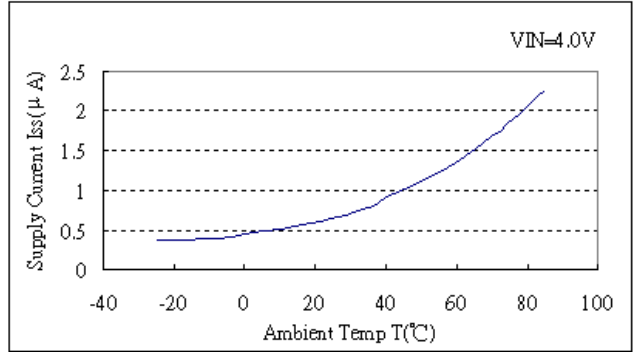

7) Input Transient Response 1

ML6206S153

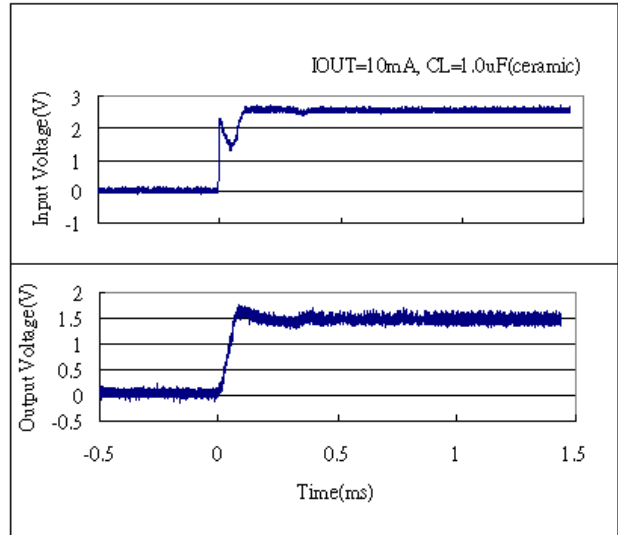
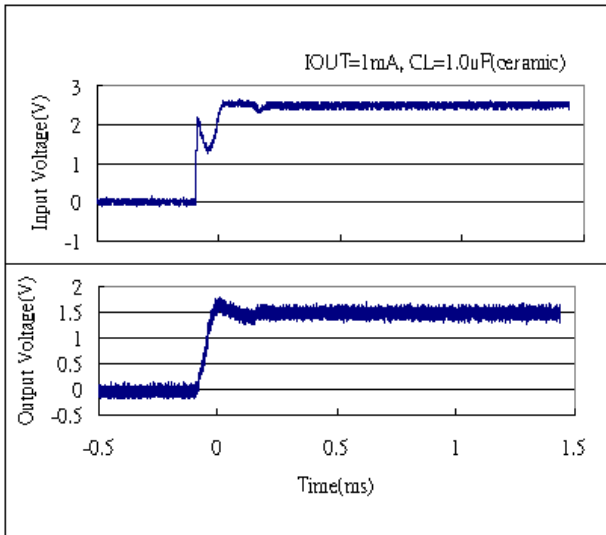



ML6206S302

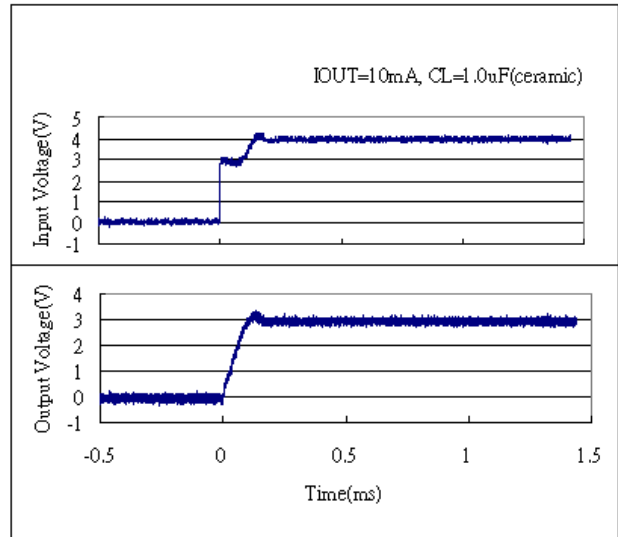
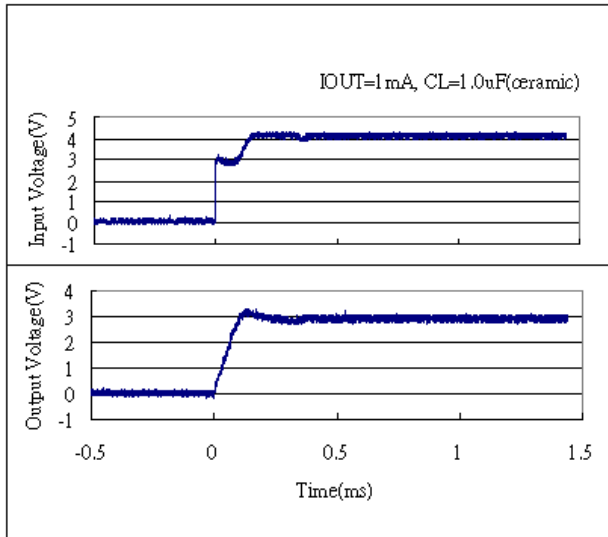

8) Input Transient Response 2

ML6206S153

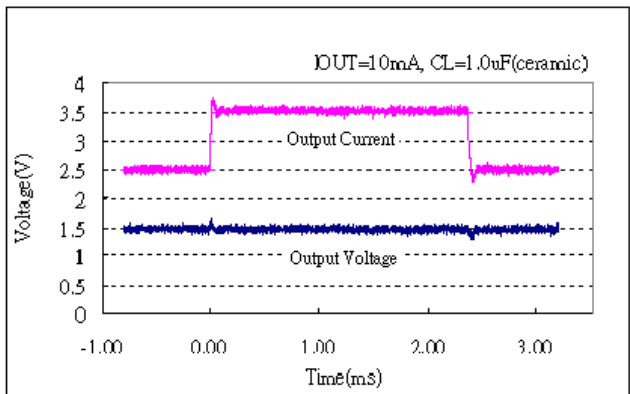
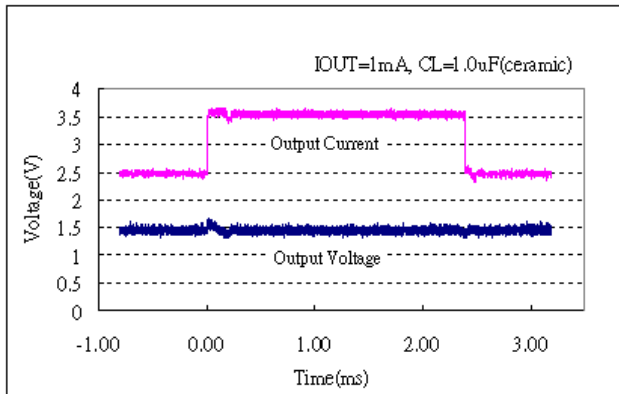

ML6206S302

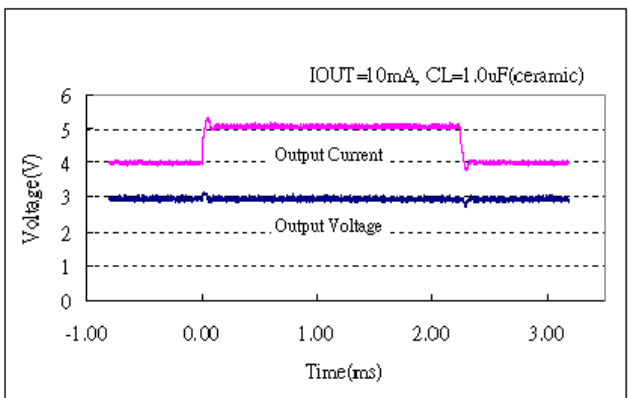
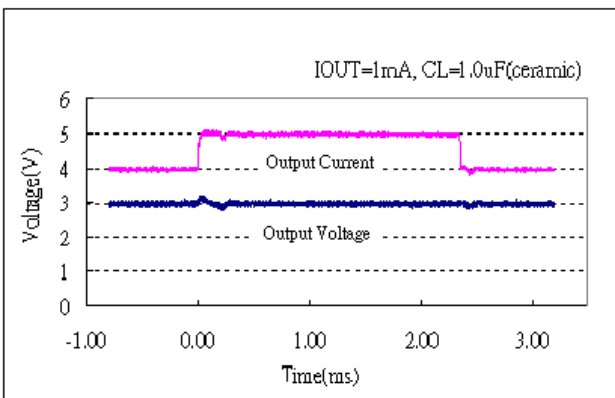

9) Load Transient Response

ML6206S272

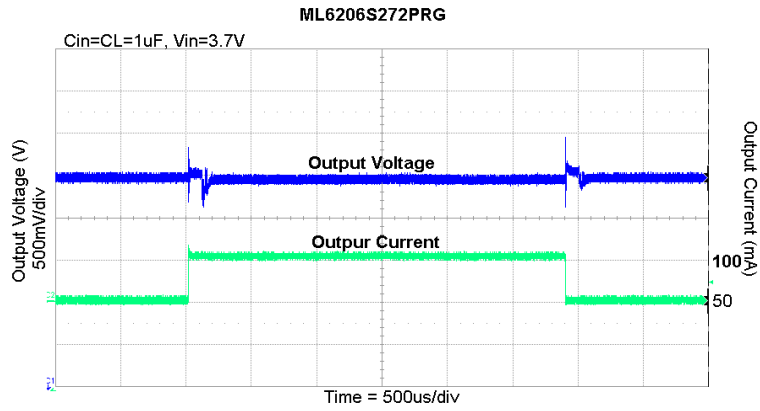

Load Current 50mA to 100mA

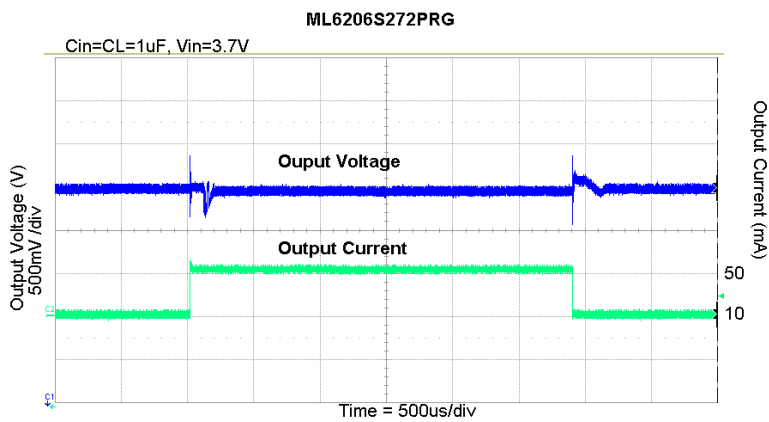

Load Current 10mA to 50mA

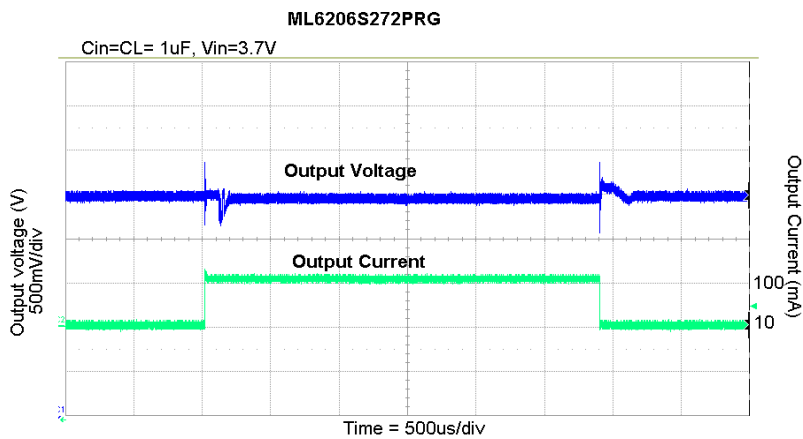

Load Current 10mA to 100mA



10) Power Supply Rejection Ratio

ML6206S153

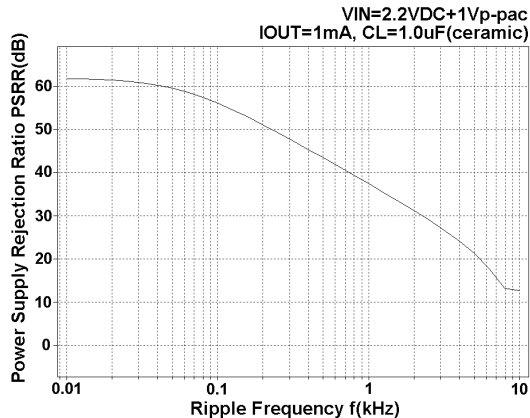

ML6206S153

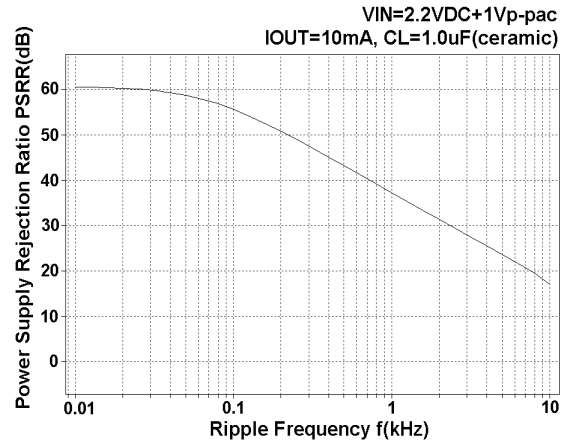

ML6206S302

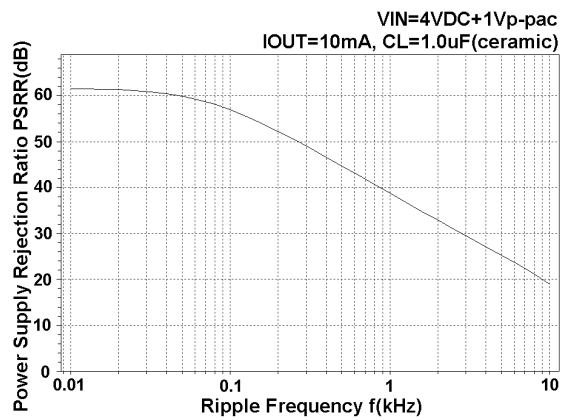
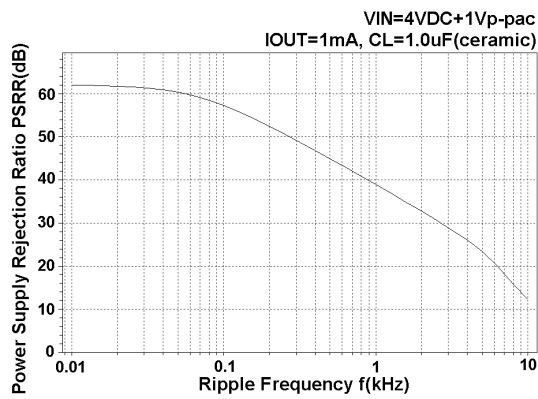

❖ Ordering Information

Designator	Description
①②	Output Voltage eg. 30=3.0V 50=5.0V
③	Output Voltage Accuracy 2 = ± 2.0% 3 = ± 3.0%
④	Package Type M = SOT-23 P = SOT-89 T = TO-92
⑤	Device Orientation R = Embossed Tape (Orientation of Device : Right) L = Embossed Tape (Orientation of Device : Left) B = Bag (TO-92) H = Paper Tape (TO-92)
⑥	G = ROHS Part

ML6206S①②③④⑤⑥

❖ *Marking*

SOT-23 :

Designator	Description
1	Type Y = Positive Voltage Regulator
2,3	Output Voltage eg. 30 = 3.0V
4	Internal Code

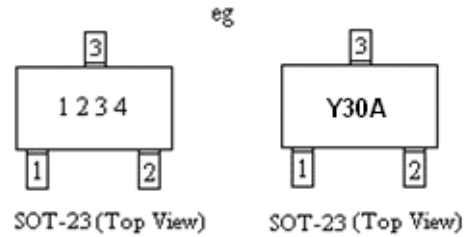

SOT-89 :

Designator	Description
1	Type Y = Positive Voltage Regulator
2,3	Output Voltage eg. 30 = 3.0V
4	Output Voltage Accuracy 2 = $\pm 2.0\%$ 3 = $\pm 3.0\%$
5	Internal Code

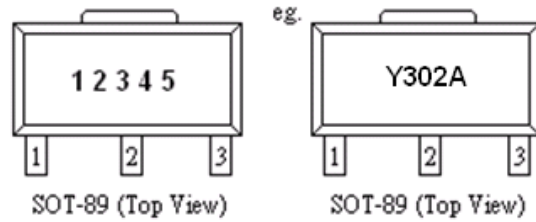

TO-92 :

Designator	Description
1	Type Y = Positive Voltage Regulator
2,3	Output Voltage eg. 30 = 3.0V
4	Output Voltage Accuracy 2 = $\pm 2.0\%$ 3 = $\pm 3.0\%$
5	Internal code
6, 7	Year Code eg. 09 = Year 2009
8, 9	Week Code eg. 10 = Week 10

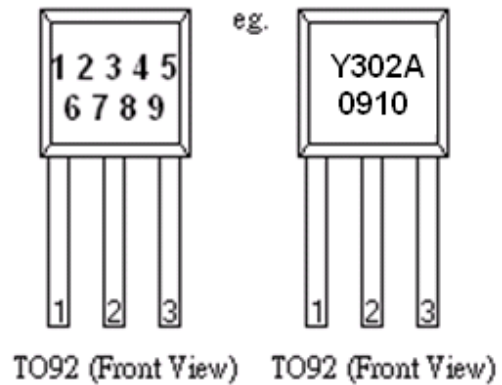

❖ **Packaging Information**

SOT-23 :

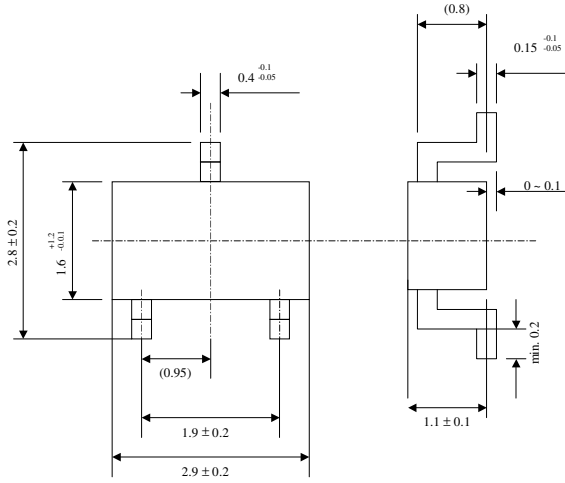

SOT-89 :

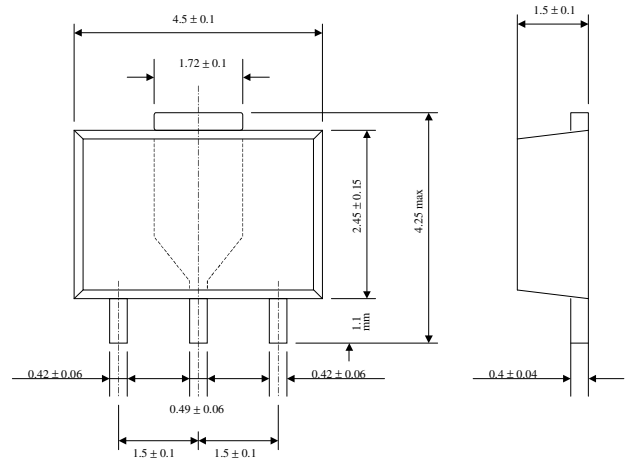

TO-92 :

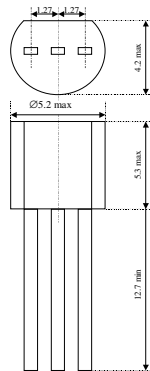

Units : mm

❖ **Recommended Pattern Layout**

SOT-23 :

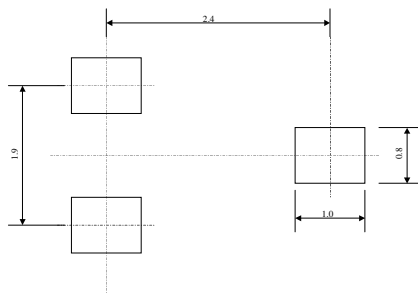

SOT-89

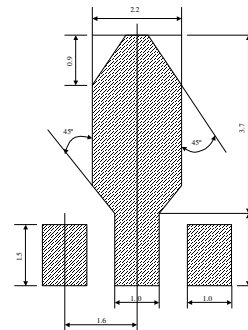

❖ *Tape and Reel Information*

SOT-23 :

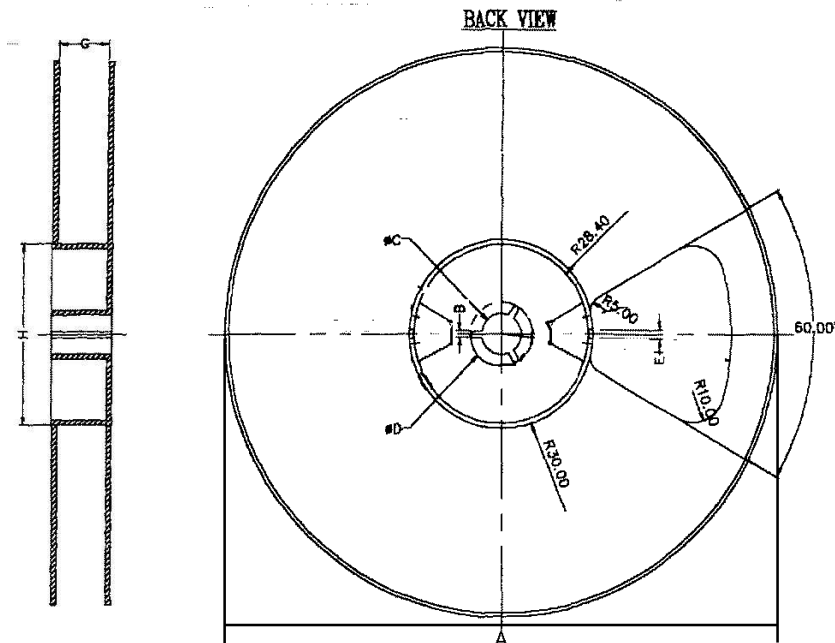

	SIZE (mm)
A	∅ 178 ± 0.8
B	2 ± 0.2
C	∅ 13 ± 0.2
D	∅ 21 ± 0.8
G	8 ± 0.5
H	∅ 60

3,000 pcs / reel

SOT-23 Taping Specifications :

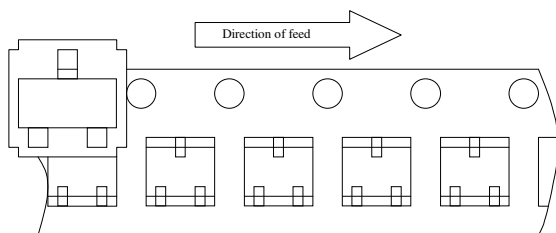
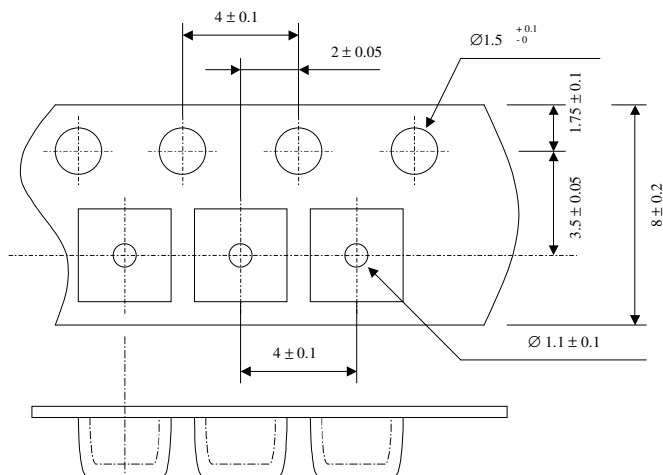

"R" type [Orientation of Device: Right]
Standard Type

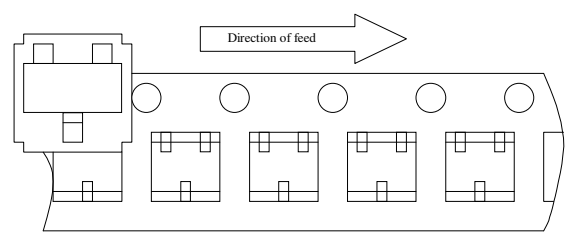

"L" type [Orientation of Device: Left]
Reverse Type

SOT-89 :

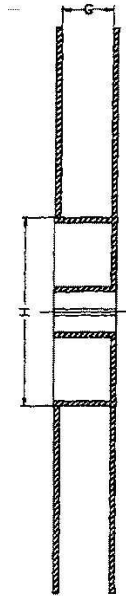
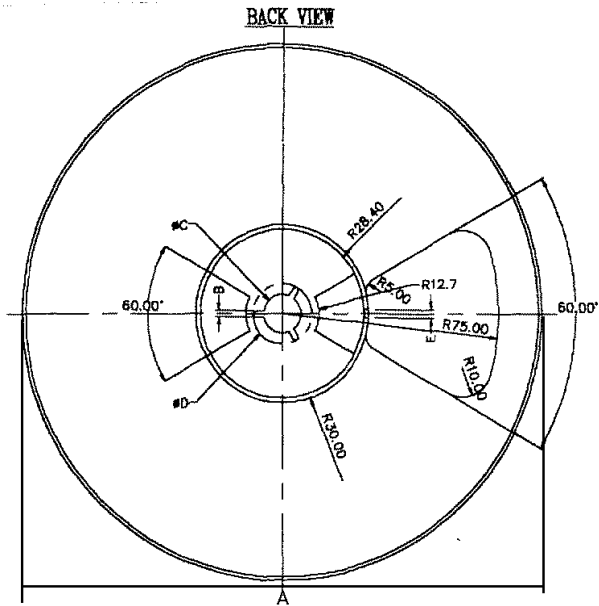

	SIZE (mm)
A	$\varnothing 178 \pm 0.8$
B	2 ± 0.2
C	$\varnothing 13 \pm 0.2$
D	$\varnothing 21 \pm 0.8$
G	12 ± 0.5
H	$\varnothing 60$

SOT-89 Taping Specifications :

1,000 pcs / reel

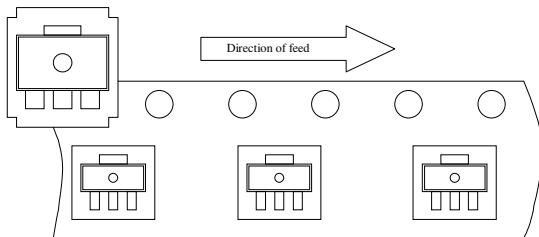
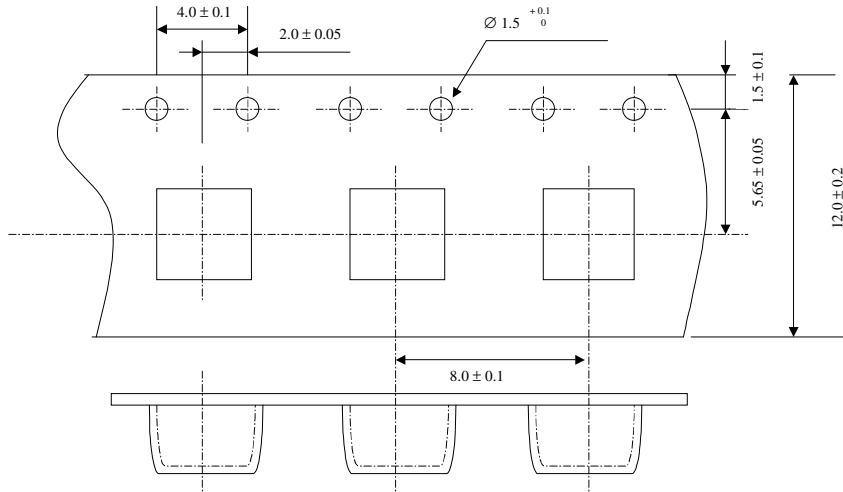

"R" type [Orientation of Device: Right]
Standard Type

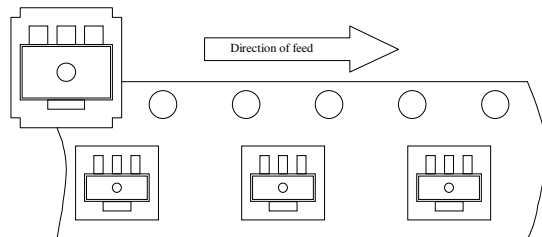

"L" type [Orientation of Device: Left]
Reverse Type

TO-92 Taping Specifications :

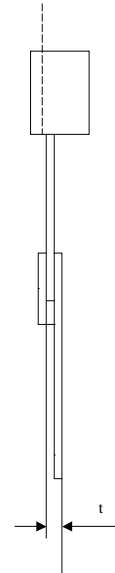
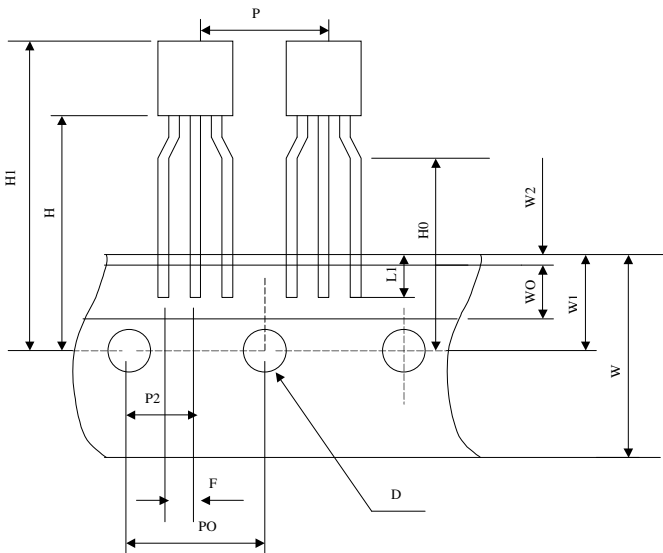

	SIZE (mm)
P	12.7 ± 1.0
PO	12.7 ± 0.3
P2	6.35 ± 0.4
F	2.5 ^{+0.45} _{-0.15}
W	18.0 ± 1.0
W0	6.0 ± 0.3
W1	9.0 ± 0.5
W2	0.5 MAX
H	19.0 ± 0.5
H0	16.0 ± 0.5
H1	32.25 MAX
D	∅ 4.0 ± 0.2
t	0.6 ± 0.2
L1	3.5 MIN

2,000 pcs / box

Minilogic reserves the rights to change the information and specifications without prior notice. The information presented in this document does not form part of any quotation or contract, is believed to be accurate and reliable and may be changed without notice. No liability will be accepted by the publisher for any consequence of its use.