

M-Pulse Microwave

Silicon Bipolar MMIC Cascadable Amplifier

MP4TD0935, MP4TD0936

Features

- Cascadable 50Ω Gain Block
- 3dB Bandwidth: DC to 4.5 GHz
- 8.0 dB Typical Gain @ 1.0 GHz
- Low SWR: <1.9 from 0.1 to 3.0 GHz
- Cost Effective Ceramic Microstrip Package
- Tape and Reel Packaging Available

Description

M-Pulse's MP4TD0935 and MP4TD0936 are high performance silicon bipolar MMICs housed in a cost effective ceramic microstrip packages. The MP4TD0935 and MP4TD0936 are designed for use where a general purpose 50Ω gain block is required. Typical applications include narrow and wide band IF and RF amplifiers in industrial and military applications.

The MP4TD0935 and MP4TD0936 are fabricated using a 10 GHz f_T silicon bipolar technology that features gold metalization and IC passivation for increased performance and reliability.

Ceramic Microstrip Case Style Outlines^{1,2,3}

Available in short lead version as MP4TD0936.

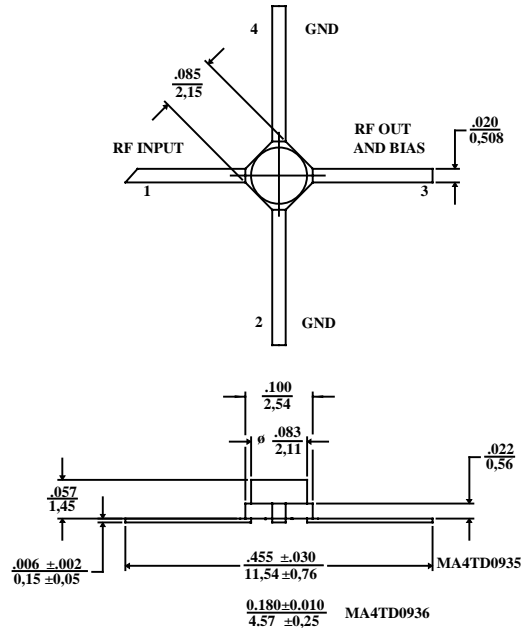

Notes: (unless otherwise specified)

1. Dimensions are in / mm
2. Tolerance: in .xxx = ±.005; mm .xx = ±.13
3. See last page of data sheet for short lead Micro-X

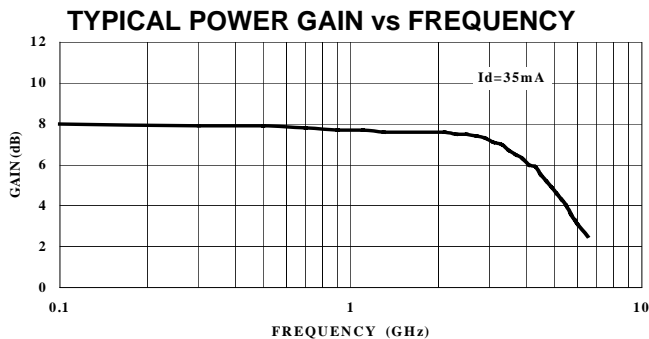

Pin Configuration

Pin Number	Pin Description
1	RF Input
2 & 4	AC/DC Ground
3	RF Output and DC Bias

Electrical Specifications @ $T_A = +25^\circ\text{C}$, $I_D = 35\text{ mA}$, $Z_0 = 50\Omega$

Symbol	Parameters	Test Conditions	Units	Min.	Typ.	Max.
G_p	Power Gain ($ S_{21} ^2$)	$f = 0.1\text{ GHz}$	dB	7.0	8.0	9.0
ΔG_p	Gain Flatness	$f = 0.1\text{ to }3.0\text{ GHz}$	dB	-	± 0.4	± 0.6
f_{3dB}	3 dB Bandwidth	-	GHz	-	4.5	-
SWR_{in}	Input SWR	$f = 0.1\text{ to }3.0\text{ GHz}$	-	-	1.9	-
SWR_{out}	Output SWR	$f = 0.1\text{ to }3.0\text{ GHz}$	-	-	1.4	-
P_{1dB}	Output Power @ 1dB Gain Compression	$f = 1.0\text{ GHz}$	dBm	-	11.5	-
NF	50 Ω Noise Figure	$f = 1.0\text{ GHz}$	dB	-	6.0	-
IP_3	Third Order Intercept Point	$f = 1.0\text{ GHz}$	dBm	-	23.0	-
t_D	Group Delay	$f = 1.0\text{ GHz}$	ps	-	100	-
V_d	Device Voltage	-	V	7.0	7.8	8.6
dV/dT	Device Voltage Temperature Coefficient	-	mV/°C	-	-16.0	-

Specification Subject to Change Without Notice

Absolute Maximum Ratings¹

Parameter	Absolute Maximum
Device Current	80 mA
Power Dissipation ^{2,3}	750 mW
RF Input Power	+20 dBm
Junction Temperature	200°C
Storage Temperature	-65°C to +200°C
Thermal Resistance: $\theta_{jC} = 145^{\circ}\text{C}/\text{W}$	

1. Exceeding these limits may cause permanent damage.
2. Case Temperature (T_C) = 25 °C.
3. Derate at 6.9 mW/°C for $T_C > 91^{\circ}\text{C}$.

Typical Bias Configuration

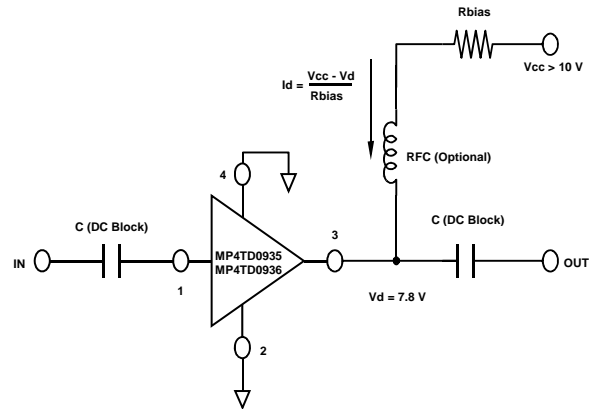

Typical Performance Curves @ $I_D = 35\text{ mA}$, $T_A = +25^{\circ}\text{C}$ (unless otherwise noted)

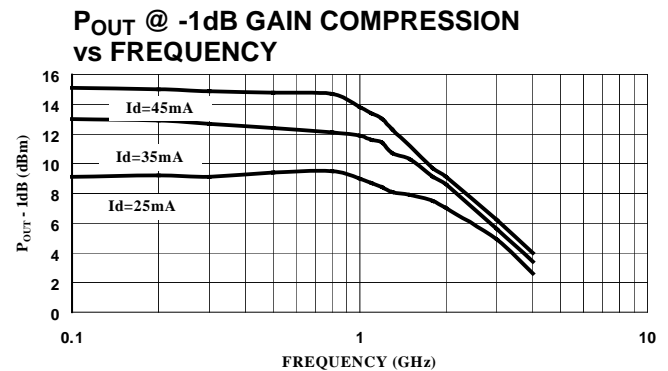
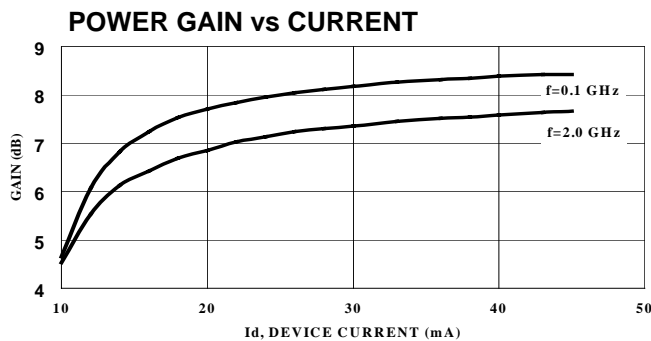
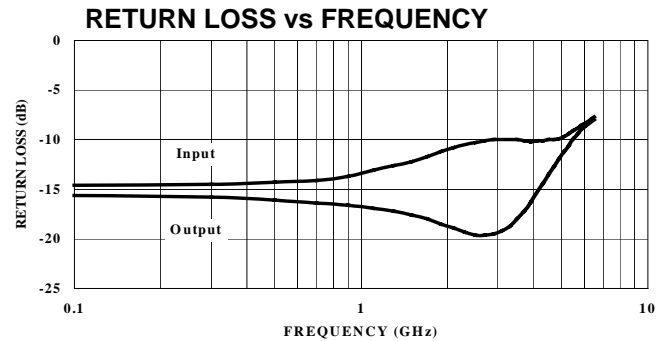
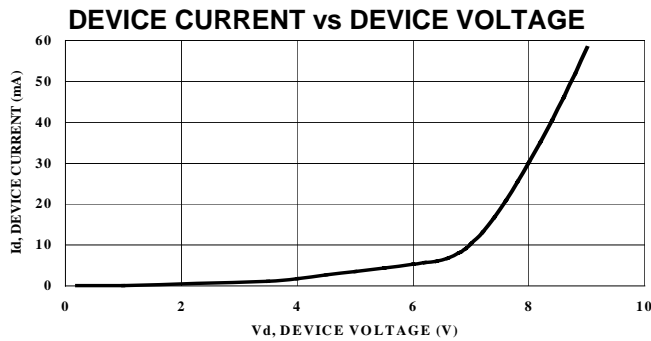

Specification Subject to Change Without Notice

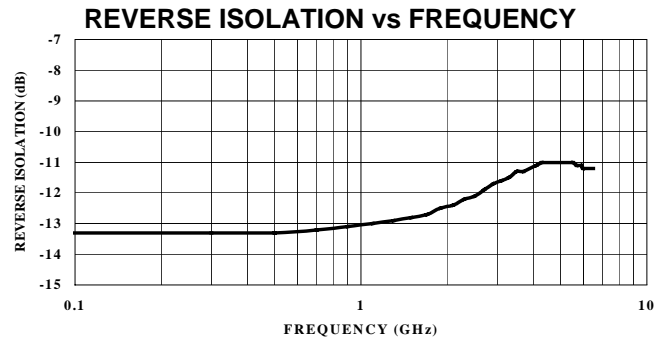
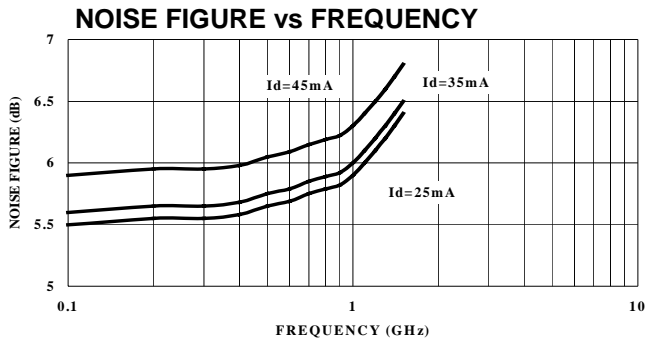

Typical Scattering Parameters

Z₀ = 50Ω, T_A = +25°C, I_d = 35 mA

Frequency (GHz)	S ₁₁		S ₂₁		S ₁₂		S ₂₂	
	Mag.	Angle	Mag.	Angle	Mag.	Angle	Mag.	Angle
0.1	0.164	-166.6	2.38	163.7	0.214	5.4	0.186	-158.0
0.2	0.162	-169.8	2.37	162.8	0.214	5.4	0.187	-159.4
0.4	0.158	-176.5	2.35	160.2	0.215	5.8	0.189	-162.3
0.6	0.153	175.9	2.33	156.7	0.216	6.5	0.194	-165.6
0.8	0.148	167.9	2.31	152.2	0.218	7.3	0.201	-169.4
1.0	0.144	162.1	2.30	146.7	0.220	8.7	0.213	-171.1
1.5	0.131	151.8	2.28	132.1	0.227	12.0	0.246	-176.1
2.0	0.116	147.0	2.27	117.4	0.236	15.0	0.280	175.4
2.5	0.104	149.7	2.24	102.2	0.248	17.2	0.304	165.5
3.0	0.106	157.1	2.17	87.2	0.259	18.6	0.313	155.3
3.5	0.127	162.0	2.06	73.2	0.269	19.2	0.315	147.3
4.0	0.164	161.4	1.93	60.6	0.276	18.6	0.308	142.6
4.5	0.212	154.1	1.78	49.4	0.280	19.4	0.313	140.2
5.0	0.266	144.6	1.64	39.1	0.281	19.7	0.323	139.7
6.0	0.365	123.0	1.35	23.7	0.275	21.5	0.381	138.6

Ordering Information

Long Lead Model No.	Short Lead Model No.	Package
MP4TD0935	MP4TD0936	Ceramic
MP4TD0935T	MP4TD0936T	Tape and Reel

Mico-X Case Styles

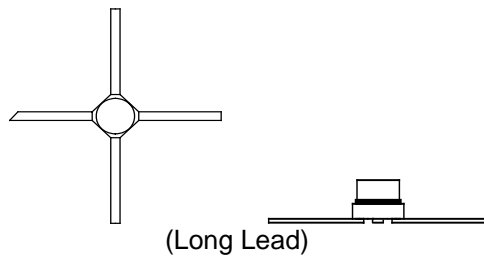

Specification Subject to Change Without Notice