

M-Pulse Microwave

Silicon Bipolar MMIC Cascadable Amplifier

MP4TD0835, MP4TD0836

Features

- Cascadable 50Ω Gain Block
- High Gain: 32.5 dB Typical Gain @ 0.1 GHz
18.5 dB Typical Gain @ 1.0 GHz
- Low Noise Figure: 3.2 dB Typical @ 1.0 GHz
- Cost Effective Ceramic Microstrip Package
- Tape and Reel Packaging Available
- Unconditionally Stable @ $k > 1$

Description

M-Pulse's MP4TD0835 and MP4TD0836 are high performance silicon bipolar MMIC housed in a cost effective ceramic microstrip package. The MP4TD0835 and MP4TD0836 are designed for use where a low noise (3.2 dB typical) general purpose 50Ω gain block is required. Typical applications include narrow and wide band IF and RF amplifiers in industrial and military applications.

The MP4TD0835 and MP4TD0836 are fabricated using a 10 GHz f_T silicon bipolar technology that features gold metalization and IC passivation for increased performance and reliability.

Ceramic Microstrip Package Outline^{1,2,3}

Available in short lead version as MP4TD0836.

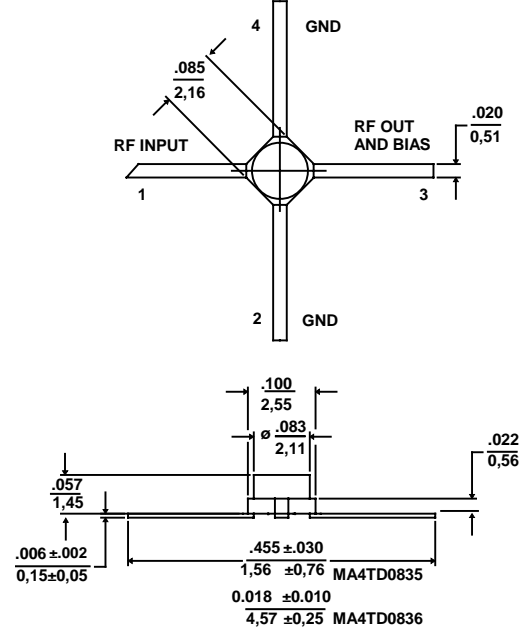

Notes: (unless otherwise specified)

1. Dimensions are in / mm
2. Tolerance: in .xxx = ±.005; mm .xx = ±.13
3. See last page of data sheet for short lead Micro-X

Pin Configuration

Pin Number	Pin Description
1	RF Input
2 & 4	AC/DC Ground
3	RF Output and DC Bias

TYPICAL POWER GAIN vs FREQUENCY

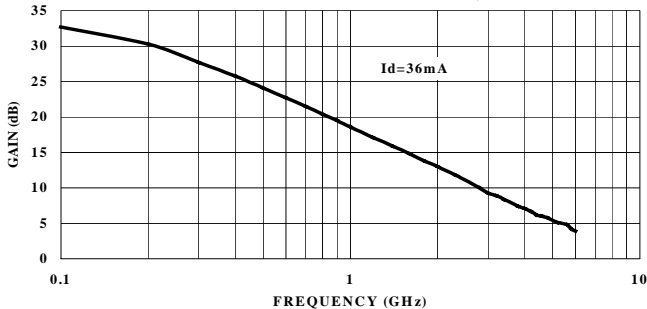

Electrical Specifications @ $T_A = +25^\circ\text{C}$, $I_d = 36$ mA, $Z_0 = 50$ Ω

Symbol	Parameters	Test Conditions	Units	Min.	Typ.	Max.
Gp	Power Gain ($ S_{21} ^2$)	f = 0.1 GHz	dB	-	32.5	-
		f = 1.0 GHz	dB	17.5	18.5	19.0
		f = 4.0 GHz	dB	-	7.0	-
SWR _{in}	Input SWR	f = 0.3 to 3.0 GHz	-	-	2.0	-
SWR _{out}	Output SWR	f = 0.4 to 3.0 GHz	-	-	1.5	-
P ₁ dB	Output Power @ 1 dB Gain Compression	f = 1.0 GHz	dBm	-	13.5	-
NF	50 Ω Noise Figure	f = 1.0 GHz	dB	-	3.2	-
IP ₃	Third Order Intercept Point	f = 1.0 GHz	dBm	-	27.0	-
t _D	Group Delay	f = 1.0 GHz	ps	-	125	-
V _d	Device Voltage	-	V	7.0	7.8	8.4
dV/dT	Device Voltage Temperature Coefficient	-	mV/°C	-	-17.0	-

Specification Subject to Change Without Notice

Absolute Maximum Ratings¹

Parameter	Absolute Maximum
Device Current	80 mA
Power Dissipation ^{2,3}	750 mW
RF Input Power	+20 dBm
Junction Temperature	200°C
Storage Temperature	-65°C to +200°C
Thermal Resistance: $\theta_{jC} = 175^{\circ}\text{C}/\text{W}$	

1. Exceeding these limits may cause permanent damage.
2. Case Temperature (T_c) = 25 °C.
3. Derate at 6.7 mW/°C for $T_c > 69^{\circ}\text{C}$.

Typical Bias Configuration

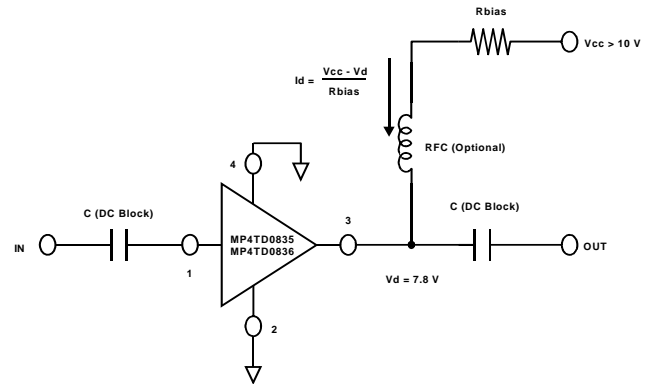

Typical Performance Curves @ $I_d = 36 \text{ mA}$, $T_A = +25^{\circ}\text{C}$ (unless otherwise noted)

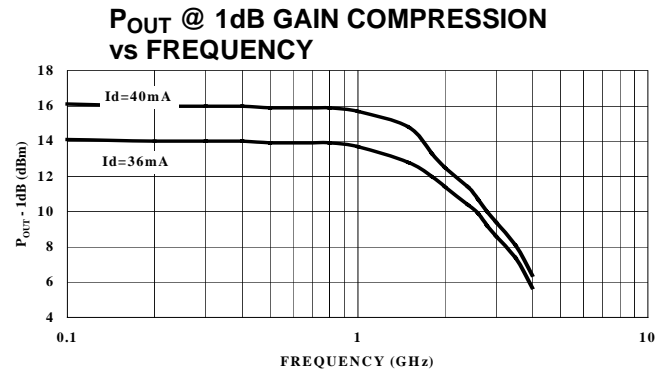
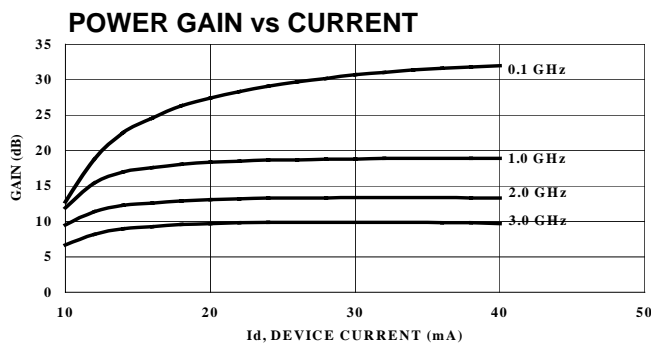
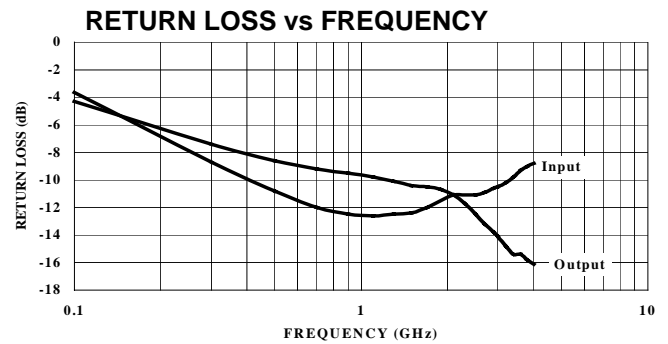
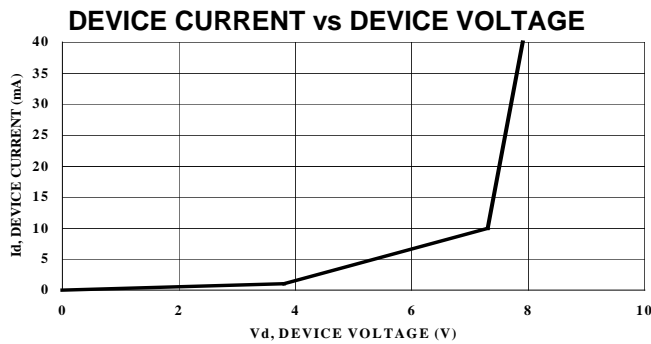

Specification Subject to Change Without Notice

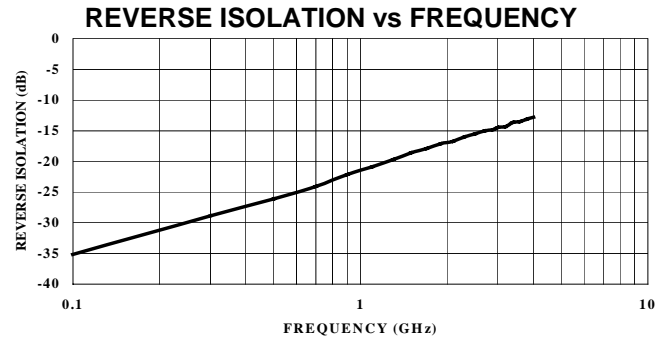
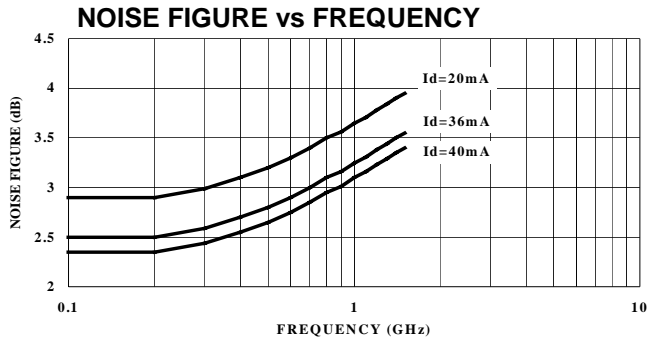

Typical Scattering Parameters
 $Z_0 = 50\Omega$, $T_A = +25^\circ\text{C}$, $I_d = 36\text{ mA}$

Frequency (GHz)	S11		S21		S12		S22	
	Mag.	Angle	Mag.	Angle	Mag.	Angle	Mag	Angle
0.1	0.656	-47.8	43.53	32.7	0.017	60.8	0.607	-52.7
0.2	0.471	-77.1	32.73	30.3	0.020	50.1	0.485	-89.4
0.4	0.311	-109.9	19.51	25.8	0.043	51.5	0.391	-129.5
0.6	0.360	-130.3	13.69	22.7	0.057	58.9	0.355	-151.2
0.8	0.242	-142.5	10.56	20.4	0.069	61.4	0.340	-165.9
1.0	0.233	-151.1	8.56	18.6	0.082	63.0	0.323	-176.4
1.5	0.239	-165.7	5.83	15.3	0.116	64.0	0.300	165.6
2.0	0.271	-178.4	4.50	13.0	0.141	61.6	0.287	151.7
2.5	0.277	168.8	3.60	11.1	0.166	61.5	0.235	140.4
3.0	0.296	160.1	2.95	9.3	0.187	61.3	0.195	137.3
3.5	0.334	152.2	2.56	8.1	0.206	59.3	0.168	140.2
4.0	0.363	140.9	2.27	7.1	0.227	60.5	0.155	145.5
4.5	0.407	131.5	2.03	6.1	0.236	57.9	0.169	153.1
5.0	0.455	120.3	1.87	5.4	0.249	60.5	0.204	155.7
6.0	0.556	99.1	1.56	3.9	0.288	62.8	0.309	151.7

Mico-X Case Styles

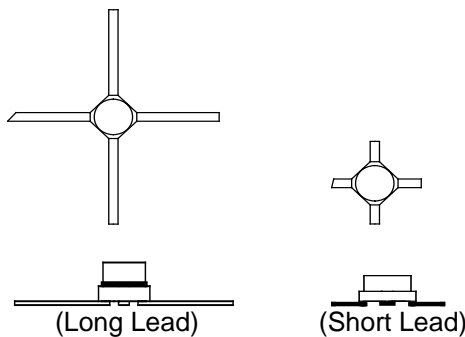

Ordering Information

Long Lead Model No.	Package
MP4TD0835	Ceramic
MP4TD0835T	Tape and Reel
Short Lead Model No.	Package
MP4TD0836	Ceramic
MP4TD0836T	Tape and Reel

Specification Subject to Change Without Notice