

M-Pulse Microwave

Silicon Bipolar MMIC Cascadable Amplifier

MP4TD0400

Features

- Cascadable 50Ω Gain Block
- 3dB Bandwidth: DC to 3.2 GHz
- 9.0 dB Typical Gain @ 1.0 GHz
- Unconditionally Stable ($k > 1$)

Description

M-Pulse's MP4TD0400 is a high performance silicon bipolar MMIC chip. The MP4TD0400 is designed for use where a general purpose 50Ω gain block is required. Typical applications include narrow and wide band IF and RF amplifiers in industrial and military applications.

The MP4TD0400 is fabricated using a 10 GHz f_T silicon bipolar technology that features gold metalization and IC passivation for increased performance and reliability.

TYPICAL POWER GAIN vs FREQUENCY

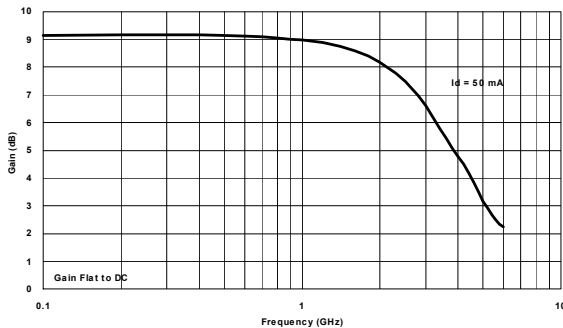

Chip Outline Drawing^{1,2,3,4}

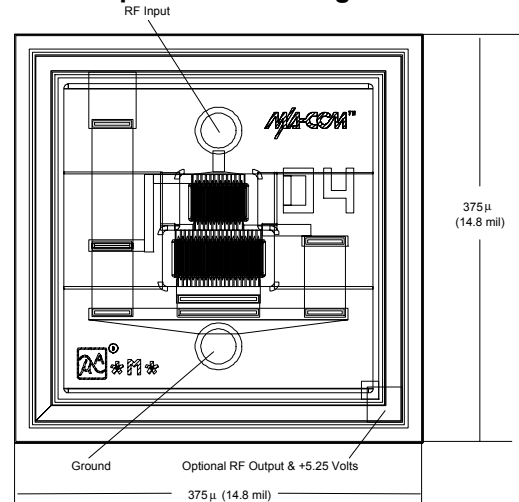

Notes: (unless otherwise specified)

1. Chip Thickness is 120 μm; 4.8 mils
2. Bond Pads are 40 μm; 1.6 mils typical in diameter
3. RF Output Contact & +DC Voltage Is Normally Made On Backside Of Chip At Die Attach
4. Tolerance: μm .xx = ±.13; mil .x = ±.5

Ordering Information

Model No.	Type of Carrier
MP4TD0400 GEL	GEL PACK
MP4TD0400 WAF	Waffle Pack
MP4TD0400 TF	Tape Frame

Electrical Specifications @ $T_A = +25^\circ\text{C}$, $I_d = 50\text{ mA}$; $Z_o = 50\Omega$

Symbol	Parameters	Test Conditions	Units	Min.	Typ.	Max.
G_p	Power Gain ($ S_{21} ^2$)	$f = 0.1\text{ GHz}$	dB	-	9.0	-
ΔG_p	Gain Flatness	$f = 0.1\text{ to }2.0\text{ GHz}$	dB	-	±0.6	-
$f_{3\text{ dB}}$	3 dB Bandwidth	-	GHz	-	3.2	-
SWR_{in}	Input SWR	$f = 0.1\text{ to }2.0\text{ GHz}$	-	-	1.4	-
SWR_{out}	Output SWR	$f = 0.1\text{ to }2.0\text{ GHz}$	-	-	1.7	-
$P_{1\text{ dB}}$	Output Power @ 1 dB Gain Compression	$f = 1.0\text{ GHz}$	dBm	-	12.5	-
NF	50 Ω Noise Figure	$f = 1.0\text{ GHz}$	dB	-	6.2	-
IP_3	Third Order Intercept Point	$f = 1.0\text{ GHz}$	dBm	-	25.5	-
t_D	Group Delay	$f = 1.0\text{ GHz}$	ps	-	125	-
V_d	Device Voltage	-	V	4.75	5.25	5.75
dV/dT	Device Voltage Temperature Coefficient	-	mV/°C	-	-8.0	-

Specification Subject to Change Without Notice

M-Pulse Microwave

1

PH (408) 432-1480 FX (408) 432-3440

Absolute Maximum Ratings¹

Parameter	Absolute Maximum
Device Current	100 mA
Power Dissipation ^{2,3}	650 mW
RF Input Power	+13 dBm
Junction Temperature	200°C
Storage Temperature	-65°C to +200°C
Thermal Resistance: $\theta_{jms} = 35 \text{ }^\circ\text{C/W}$	

1. Exceeding these limits may cause permanent damage.
2. Mounting Surface Temperature (T_{MS}) = 25 °C.
3. Derate at 28.6 mW/°C for $T_{MS} > 177^\circ\text{C}$

Typical Bias Configuration

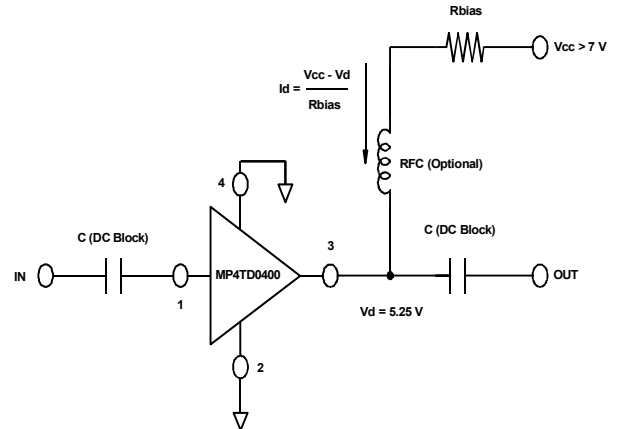

Typical Performance Curves @ $I_d = 50 \text{ mA}$, $T_A = +25^\circ\text{C}$ (unless otherwise noted)

DEVICE CURRENT vs DEVICE VOLTAGE

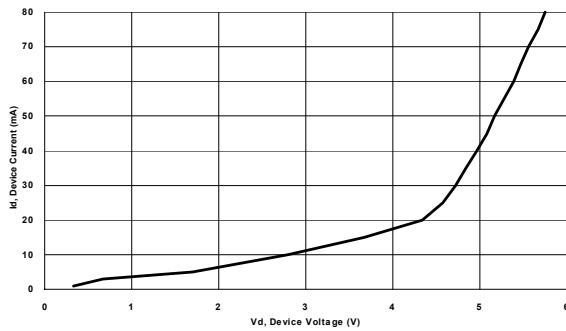

RETURN LOSS vs FREQUENCY

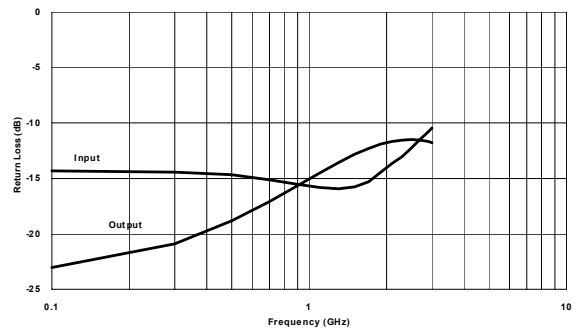

POWER GAIN vs CURRENT

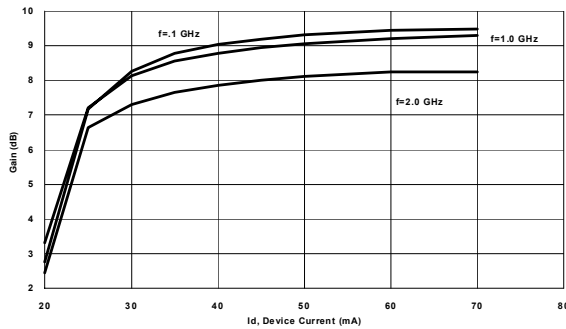

P_{OUT} @ -1DB GAIN COMPRESSION vs FREQUENCY

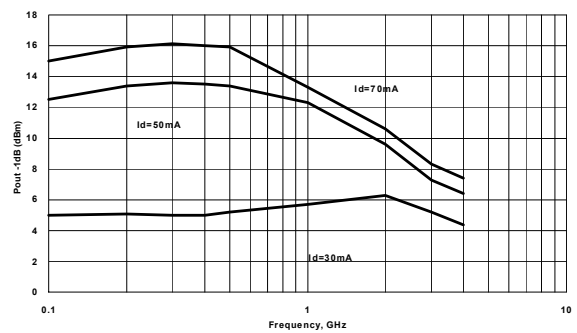

Specification Subject to Change Without Notice

NOISE FIGURE vs FREQUENCY

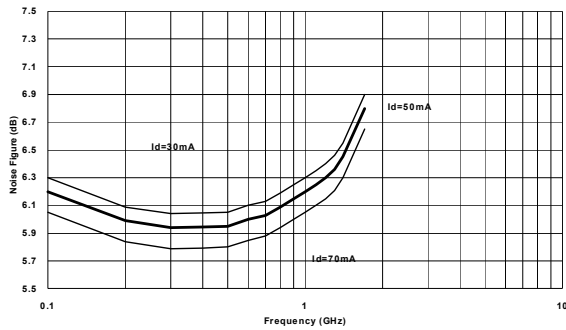

REVERSE ISOLATION vs FREQUENCY

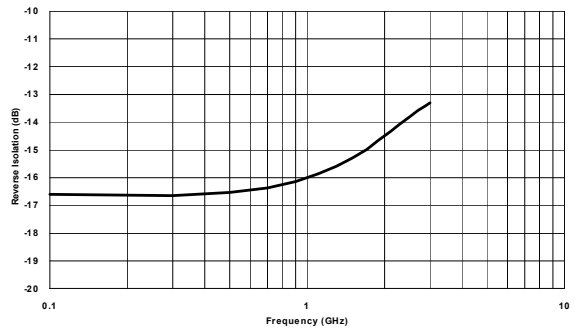

Typical Scattering Parameters

Z₀ = 50Ω, T_A = +25°C, I_D = 50 mA

Frequency (GHz)	S ₁₁		S ₂₂		S ₁₂		S ₂₁	
	Mag.	Angle	Mag.	Angle	Mag.	Angle	Mag	Angle
0.1	0.192	169.4	2.86	174.6	0.148	4.9	0.070	3.8
0.2	0.191	170.2	2.86	171.9	0.147	5.4	0.079	-12.4
0.4	0.188	171.7	2.86	164.9	0.147	7.3	0.102	-47.9
0.6	0.180	170.6	2.85	157.3	0.150	10.4	0.128	-73.9
0.8	0.171	169.6	2.83	149.8	0.154	13.8	0.153	-90.2
1.0	0.165	170.1	2.80	142.4	0.158	17.0	0.177	-102.2
1.5	0.163	176.1	2.71	124.2	0.172	24.0	0.228	-126.3
2.0	0.199	-178.6	2.57	106.6	0.188	28.6	0.258	-146.0
2.5	0.245	179.8	2.37	88.7	0.204	31.4	0.266	-161.5
3.0	0.300	173.3	2.14	75.6	0.216	33.8	0.258	-171.2
3.5	0.355	163.9	1.91	64.4	0.228	35.5	0.253	-177.6
4.0	0.407	153.3	1.73	55.0	0.234	37.2	0.251	178.5
4.5	0.456	142.3	1.58	46.2	0.241	40.3	0.262	176.4
5.0	0.508	131.2	1.44	39.1	0.252	42.8	0.279	173.8

Specification Subject to Change Without Notice