

NPTB00050

Not recommended for new designs

Contact applications@nitronex.com for questions or support



Gallium Nitride 28V, 50W RF Power Transistor

Built using the SIGANTIC® NRF1 process - A proprietary GaN-on-Silicon technology

FEATURES

- Optimized for broadband operation from DC - 4000MHz
- 50W P_{3dB} CW narrowband power
- 25W P_{3dB} CW broadband power from 500-1000MHz
- Characterized for operation up to 32V
- 100% RF tested
- Thermally enhanced industry standard package
- High reliability gold metallization process
- Lead-free and RoHS compliant
- Subject to ECCN 3A982.a.1 export control



**Broadband
50 Watt, 28 Volt
GaN HEMT**



RF Specifications (CW): $V_{DS} = 28V$, $I_{DQ} = 450mA$, Frequency = 3000MHz, $T_C = 25^\circ C$, Measured in Nitronex Test Fixture

Symbol	Parameter	Min	Typ	Max	Units
P_{3dB}	Average Output Power at 3dB Gain Compression	45	50	-	W
P_{1dB}	Average Output Power at 1dB Gain Compression	33	38	-	W
G_{SS}	Small Signal Gain	10.5	11.5	-	dB
η	Peak Drain Efficiency at $P_{OUT} = P_{3dB}$	55	60	-	%
ψ	Output mismatch stress, VSWR = 7:1, all phase angles, $P_{OUT} = P_{1dB}$	No Performance Degradation After Test			

Typical OFDM Performance: $V_{DS} = 28V$, $I_{DQ} = 300mA$, Single carrier OFDM waveform 64-QAM 3/4, 8 burst, continuous frame data, 10MHz channel bandwidth. Peak/Avg = 10.3dB @ 0.01% probability on CCDF. Frequency = 2400 to 2600MHz. $P_{OUT,AVG} = 6W$, $T_C = 25^\circ C$.

Symbol	Parameter	Typ	Units
G_P	Power Gain	12.0	dB
η	Drain Efficiency	23	%
EVM	Error Vector Magnitude	2.0	%

NPTB00050

Not recommended for new designs

Contact applications@nitronex.com for questions or support



DC Specifications: $T_C = 25^\circ\text{C}$

Symbol	Parameter	Min	Typ	Max	Units
Off Characteristics					
V_{BDS}	Drain-Source Breakdown Voltage ($V_{GS} = -8\text{V}$, $I_D = 16\text{mA}$)	100	-	-	V
I_{DLK}	Drain-Source Leakage Current ($V_{GS} = -8\text{V}$, $V_{DS} = 60\text{V}$)	-	0.1	16	mA
On Characteristics					
V_T	Gate Threshold Voltage ($V_{DS} = 28\text{V}$, $I_D = 16\text{mA}$)	-2.3	-1.8	-1.3	V
V_{GSQ}	Gate Quiescent Voltage ($V_{DS} = 28\text{V}$, $I_D = 450\text{mA}$)	-2.0	-1.5	-1.0	V
R_{ON}	On Resistance ($V_{GS} = 2\text{V}$, $I_D = 120\text{mA}$)	-	0.25	0.40	Ω
I_D	Drain Current ($V_{DS} = 7\text{V}$ pulsed, $300\mu\text{s}$ pulse width, 0.2% duty cycle, $V_{GS} = 2\text{V}$)	9.2	9.8	-	A

Absolute Maximum Ratings: Not simultaneous, $T_C = 25^\circ\text{C}$ unless otherwise noted

Symbol	Parameter	Max	Units
V_{DS}	Drain-Source Voltage	100	V
V_{GS}	Gate-Source Voltage	-10 to 3	V
I_G	Gate Current	80	mA
P_T	Total Device Power Dissipation (Derated above 25°C)	55	W
θ_{JC}	Thermal Resistance (Junction-to-Case)	3.2	$^\circ\text{C}/\text{W}$
T_{STG}	Storage Temperature Range	-65 to 150	$^\circ\text{C}$
T_J	Operating Junction Temperature	200	$^\circ\text{C}$
HBM	Human Body Model ESD Rating (per JESD22-A114)	1B (>500V)	
MM	Machine Model ESD Rating (per JESD22-A115)	M2 (>100V)	

Not Recommended for New Designs

Not Recommended for New Designs

Load-Pull Data, Reference Plane at Device Leads

$V_{DS}=28V$, $I_{DQ}=450mA$, $T_A=25^\circ C$ unless otherwise noted

Table 1: Optimum Source and Load Impedances for CW Gain, Drain Efficiency, and Output Power Performance

Frequency (MHz)	$Z_S (\Omega)$	$Z_L (\Omega)$	$P_{SAT} (W)$	Gain (dB)	Drain Efficiency @ P_{SAT} (%)
2000	3.2 - j3.5	4.8 - j2.5	50	15.0	65
2400	3.1 - j7.5	5.0 - j3.5	50	13.8	62
2500	3.1 - j8.4	5.2 - j3.6	50	13.8	62
2600	3.2 - j9.4	5.3 - j3.7	50	13.5	61
2700	3.7 - j11.0	5.2 - j4.9	50	13.1	60
3000	4.4 - j13.0	5.2 - j5.3	50	13.0	60

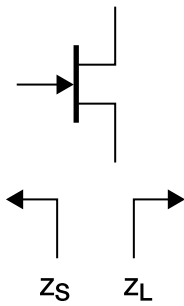

Z_S is the source impedance presented to the device.

Z_L is the load impedance presented to the device.

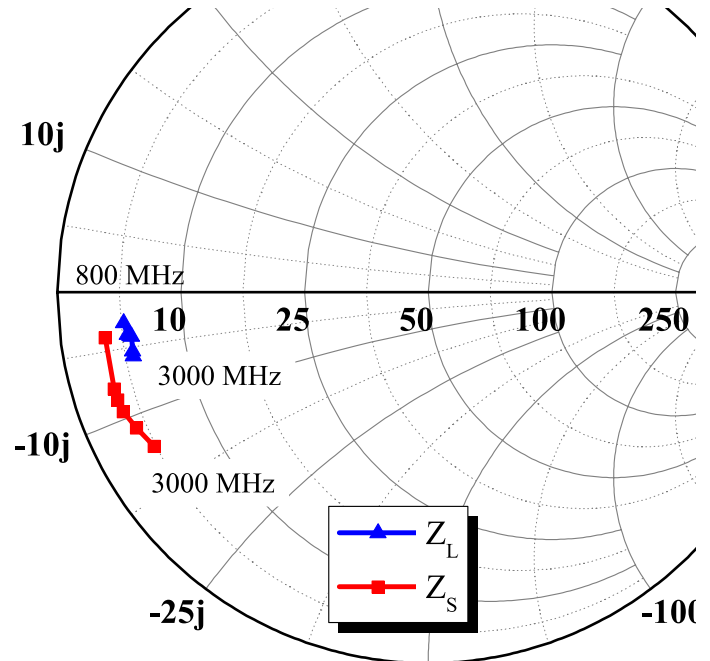

Figure 1 - Optimal Impedances for CW Performance, $V_{DS} = 28V$, $I_{DQ} = 450mA$

Load-Pull Data, Reference Plane at Device Leads

$V_{DS}=28V$, $I_{DQ}=450mA$, $T_A=25^\circ C$ unless otherwise noted.

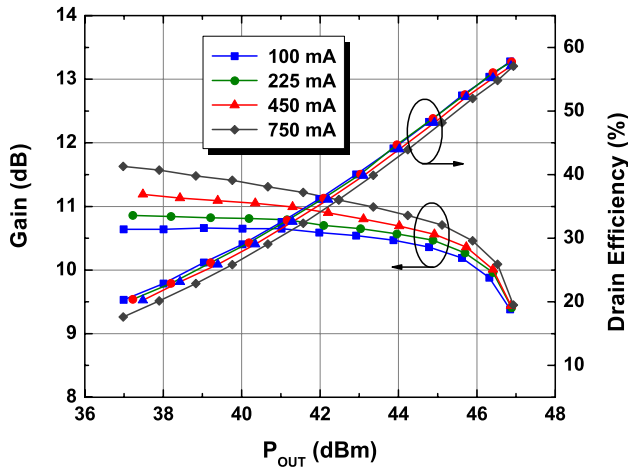

Figure 2 - Typical CW Performance vs. I_{DQ}
 $V_{DS} = 28V$, 3000MHz

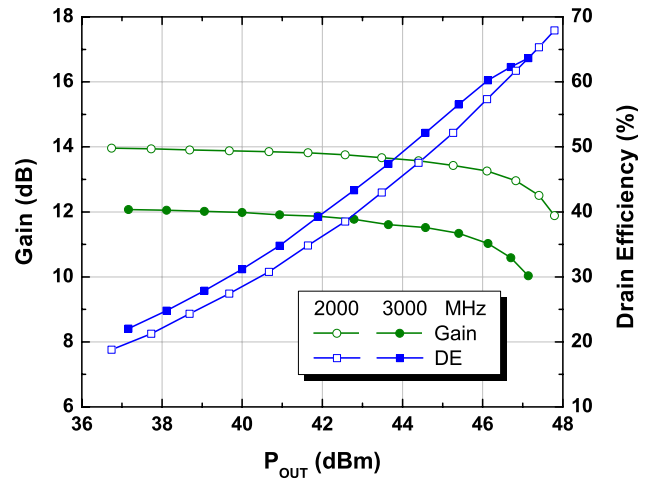

Figure 3 - Typical CW Performance
 $V_{DS} = 28V$, $I_{DQ} = 450mA$

Not Recommended for New Designs

Not Recommended for New Designs

Typical Device Characteristics

$V_{DS}=28V$, $I_{DQ}=450mA$, $T_A=25^\circ C$ unless otherwise noted.

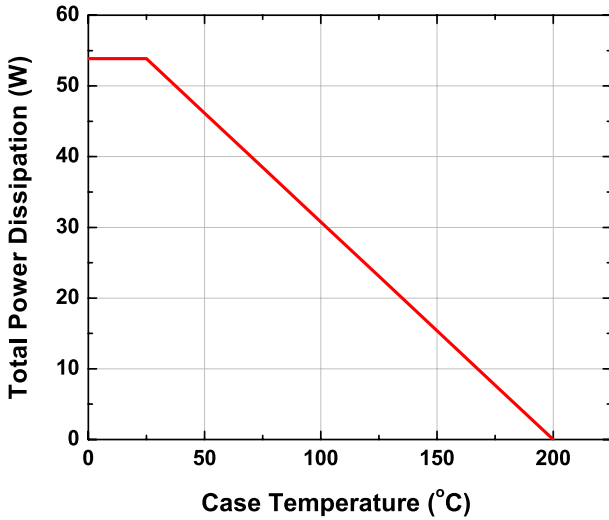

Figure 4 - Power Derating Curve

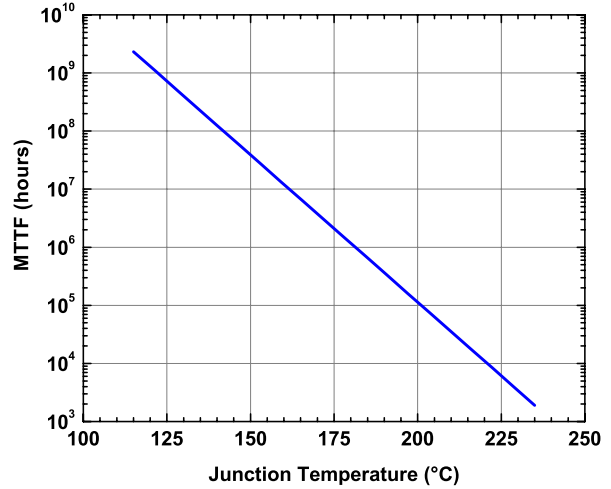

Figure 5 - MTTF of NRF1 Devices as a Function of Junction Temperature

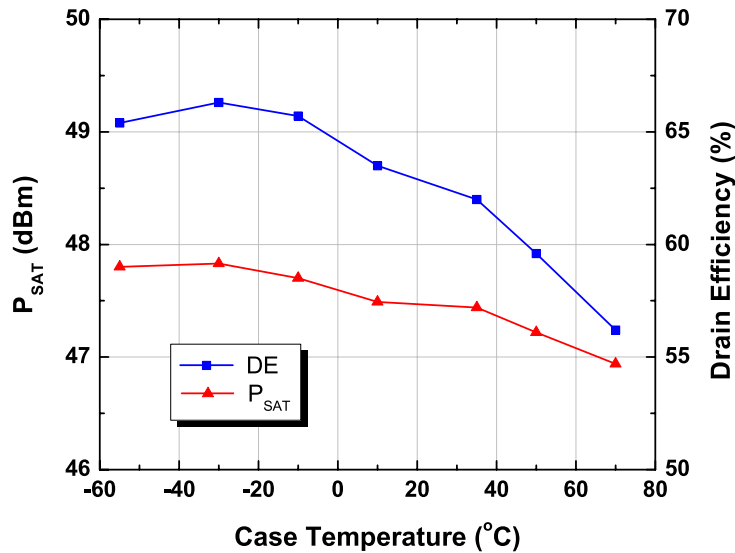

Figure 6 - Typical CW Performance vs. Temperature in Nitronex Test Fixture, $V_{DS} = 28V$, $I_{DQ} = 450 mA$, 3000MHz

Not Recommended for New Designs

Not Recommended for New Designs

NPTB00050

Not recommended for new designs

Contact applications@nitronex.com for questions or support



NPTB00050, 3000MHz CW Production Test Fixture

$V_{DS}=28V$, $I_{DQ}=450mA$, $T_A=25^\circ C$ unless otherwise noted. Additional design information and data available at www.nitronex.com.

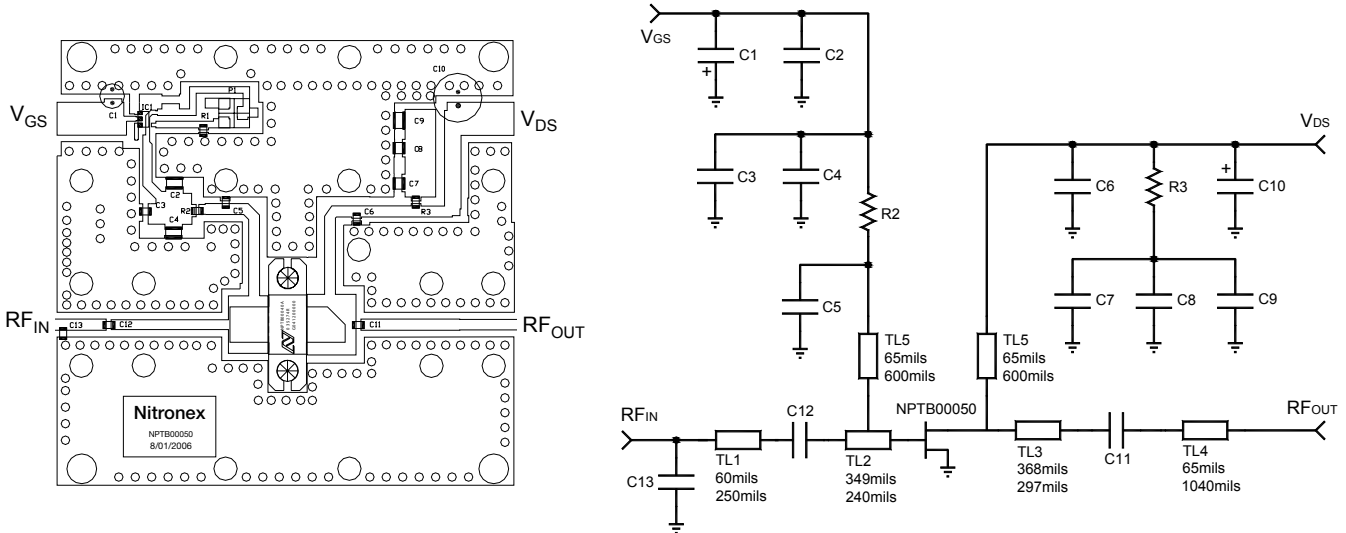

Figure 7 - NPTB00050 3000MHz Test Fixture

Table 2: NPTB00050 3000MHz Test Fixture Bill of Materials

Name	Value	Vendor	Vendor Number
C1	150uF	Nichicon	UPW1C151MED
C10	270uF	United Chmi-Con	ELXY630ELL271MK25S
C3, C7	0.01uF	AVX	12061C103KAT2A
C2, C8	0.1uF	Kemet	C1206C104K1RACTU
C4, C9	1.0 uF	Panasonic	ECJ-5YB2A105M
C5, C6, C12	5.6pF	ATC	ATC600F5R6CT
C11	1.8pF	ATC	ATC600F1R8AT
C13	0.7pF	ATC	ATC600F0R7AT
R2	33 ohm	Panasonic	ERJ-6ENF33R0V
R3	0.33 ohm	Panasonic	ERJ-6RQFR33V
Substrate	-	Taconic	RF35, t=30mil, $\epsilon_r=3.5$

Not Recommended for New Designs

Not Recommended for New Designs

NPTB00050

Not recommended for new designs

Contact applications@nitronex.com for questions or support



Ordering Information¹

Part Number	Description
NPTB00050B	NPTB00050 in AC360B-F2 Bolt-Down Package

1: To find a Nitronex contact in your area, visit our website at <http://www.nitronex.com>

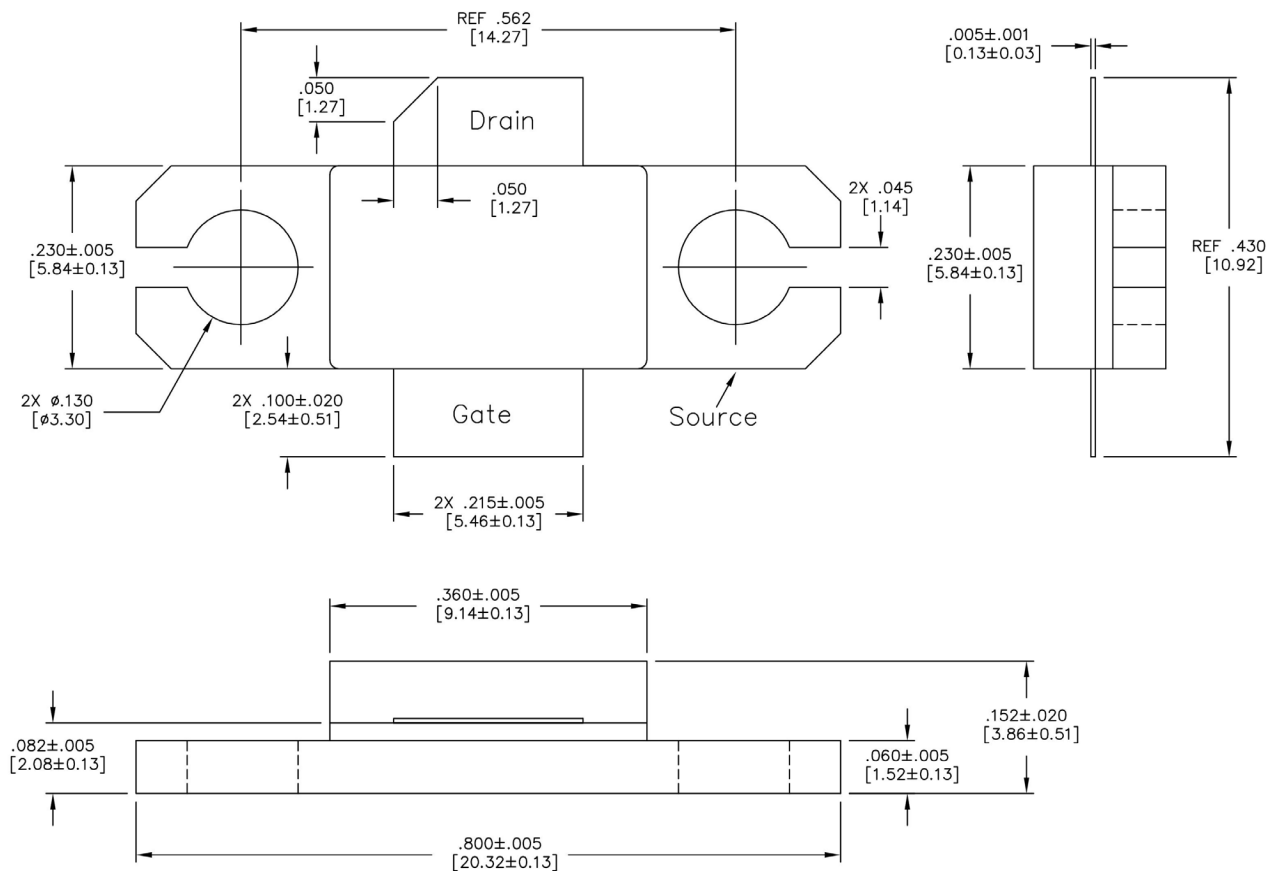

Figure 8 - AC360B-F2 Package Dimensions and Pinout (all dimensions are in inches)

Not Recommended for New Designs

Not Recommended for New Designs

NPTB00050

Not recommended for new designs

Contact applications@nitronex.com for questions or support



Nitronex, LLC

2305 Presidential Drive
Durham, NC 27703 USA
+1.919.807.9100 (telephone)
+1.919.807.9200 (fax)
info@nitronex.com
www.nitronex.com

Additional Information

**This part is lead-free and is compliant with the RoHS directive
(Restrictions on the Use of Certain Hazardous Substances in Electrical and Electronic Equipment).**

Important Notice

Nitronex, LLC reserves the right to make corrections, modifications, enhancements, improvements and other changes to its products and services at any time and to discontinue any product or service without notice. Customers should obtain the latest relevant information before placing orders and should verify that such information is current and complete. All products are sold subject to Nitronex terms and conditions of sale supplied at the time of order acknowledgment. The latest information from Nitronex can be found either by calling Nitronex at 1-919-807-9100 or visiting our website at www.nitronex.com.

Nitronex warrants performance of its packaged semiconductor or die to the specifications applicable at the time of sale in accordance with Nitronex standard warranty. Testing and other quality control techniques are used to the extent Nitronex deems necessary to support the warranty. Except where mandated by government requirements, testing of all parameters of each product is not necessarily performed.

Nitronex assumes no liability for applications assistance or customer product design. Customers are responsible for their product and applications using Nitronex semiconductor products or services. To minimize the risks associated with customer products and applications, customers should provide adequate design and operating safeguards.

Nitronex does not warrant or represent that any license, either express or implied, is granted under any Nitronex patent right, copyright, mask work right, or other Nitronex intellectual property right relating to any combination, machine or process in which Nitronex products or services are used.

Reproduction of information in Nitronex data sheets is permitted if and only if said reproduction does not alter any of the information and is accompanied by all associated warranties, conditions, limitations and notices. Any alteration of the contained information invalidates all warranties and Nitronex is not responsible or liable for any such statements.

Nitronex products are not intended or authorized for use in life support systems, including but not limited to surgical implants into the body or any other application intended to support or sustain life. Should Buyer purchase or use Nitronex, LLC products for any such unintended or unauthorized application, Buyer shall indemnify and hold Nitronex, LLC, its officers, employees, subsidiaries, affiliates, distributors, and its successors harmless against all claims, costs, damages, and expenses, and reasonable attorney fees arising out of, directly or indirectly, any claim of personal injury or death associated with such unintended or unauthorized use, notwithstanding if such claim alleges that Nitronex was negligent regarding the design or manufacture of said products.

Nitronex and the Nitronex logo are registered trademarks of Nitronex, LLC.
All other product or service names are the property of their respective owners.
©Nitronex, LLC 2012. All rights reserved.