

**Fieldbus cables for fieldbus systems
according to IEC61158-2, 4-pole
RKCV-FBY48OG-2M/5D**

- Fieldbus cable, type A, acc.to IEC 61158-2
- PVC jacket, orange
- Oil, gas and sunlight resistant
- Temperature range -40...+75 °C
- Cable cross section: 18/7 AWG (0.8 mm²)
- Open end
- M12 x 1 female, straight, stainless steel
- Cable length 2 m

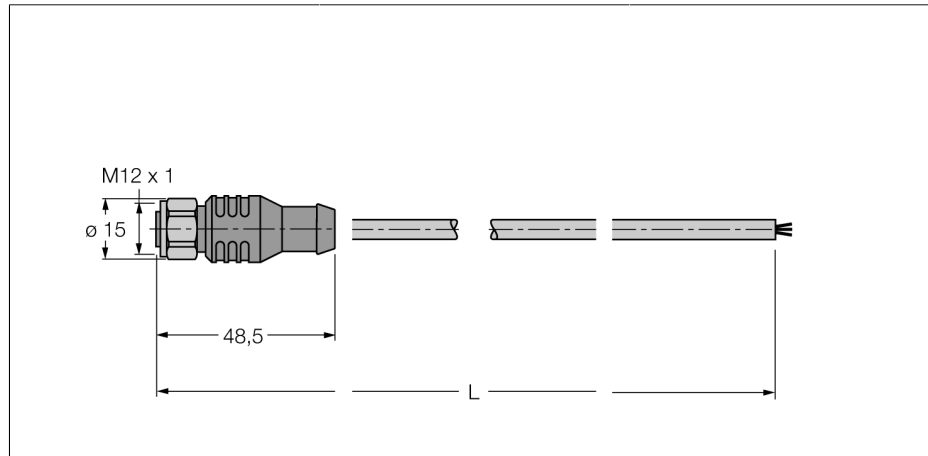

Conductor cross-section

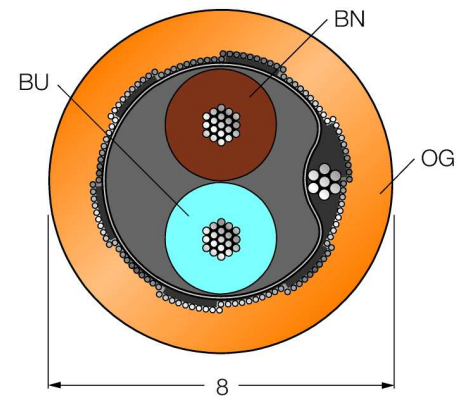

pin configuration left

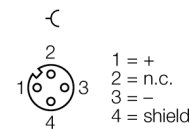

Type code	RKCV-FBY48OG-2M/5D
Ident no.	8900165
Connector A side	female connector, M12 x 1, straight
Number of pins	4
Contacts	metal, CuZn, gold-plated
Contact carriers	plastic, TPU, black
Grip	plastic, PUR, black
Coupling nut/screw	1.4404
Protection class	IP67
Cable diameter	7.8mm
Cable length	2m
Cable sheath	PVC, orange
Shield	aluminium foil, tinned copper braid and stranded filler drain wire
Max. tensile strength	≤ 90 N
Core insulation	PE-foam with PE-casing
Core colors	BN, BU
Core cross-section	2x0.8mm ²
DC resistance (loop)	43.6 Ω /km
Nom. Impedance	100 ± 20 (31.25 kBit/s) Ω
Rated voltage [U_{max}]	300 V
Ambient temperature at rest	-40 ... 75°C
In moving state	-5 ... 50°C
UV resistance	gem. UL 1581, section 1200
resistance to oil	according to ICEA S82-552
flame-retardant	according to IEC 60332-1