

**Fieldbus cables for fieldbus systems
according to IEC61158-2
CABLE FBA-YE/SD 500M**

- Fieldbus cables, type A, acc.to IEC 61158-2
- PVC jacket, yellow
- Armouring: Round steel wires
- Oil, gas and sunlight resistant
- Temperature range -40...+75 °C
- Cable cross section: 18/7 AWG (0.8 mm²)
- Cable length: 500 m

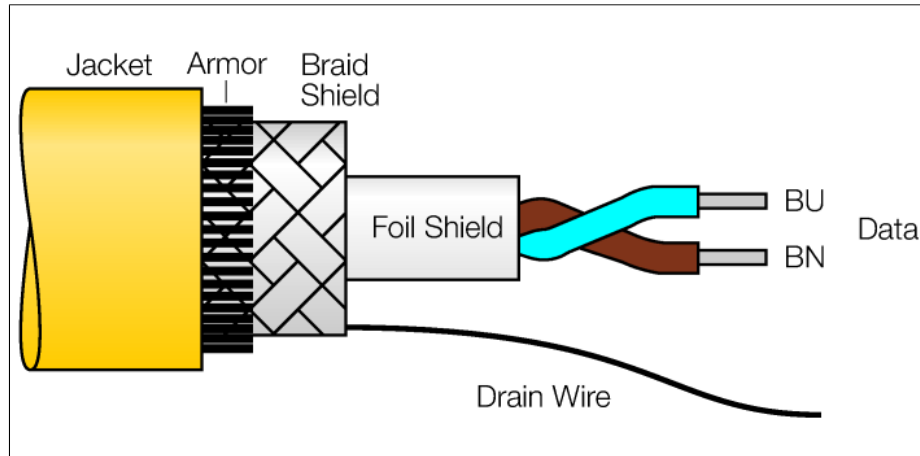

Conductor cross-section

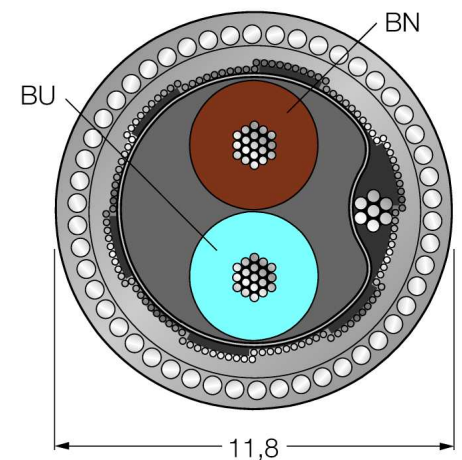

Type code	CABLE FBA-YE/SD 500M
Ident no.	6611492
Cable	18/7 AWG (0.8 mm ²), stranded plain copper
Cable length	500m
Cable sheath	PVC, yellow
Shield	plastic-covered aluminium foil, metal side outside, makes contact with tinned drain wire and copper braid
Max. tensile strength	≤ 90 N
Core insulation	PE-foam with PE-casing
Core colors	BN, BU
Core cross-section	2x0.8mm ²
DC resistance (loop)	43.6 Ω /km
Armouring	Round steel wires, zinc plated
Diameter	0.9 mm
Shield resistance	Nom. 9 Ω /km
Nom. Impedance	100 ± 20 (31.25 kBit/s) Ω
Working capacitance	Nom. 60 nF/km
Capacitive earthing	max. 2 nF/km
Damping	max. 3.0 dB/km (with f = 39 kHz)
skew	max. 1.7 µs/km (7.9 kHz -39 kHz)
Nom. Inductance	0.7 mH/km
Rated voltage [Umax]	300 V
Ambient temperature at rest	-40 ... 75°C
In moving state	-5 ... 50°C
Approvals	UL
UV resistance	gem. UL 1581, section 1200
resistance to oil	according to ICEA S82-552
flame-retardant	IEC 60332-3