

- A special software (function module) for integration in PLC systems is not required.
- Cable max. 50 m between interface and read/write head
- Rotary coding switch to adjust the bus address
- Maximum transmission rate to the fieldbus 120/250/500 kbps
- LEDs for display of supply voltage, group and bus errors as well as status and diagnostics
- Connection of up to 8 read/write heads via BL ident extension cables
- Mixed operation of HF and UHF read/write heads

### Connectors .../S2500

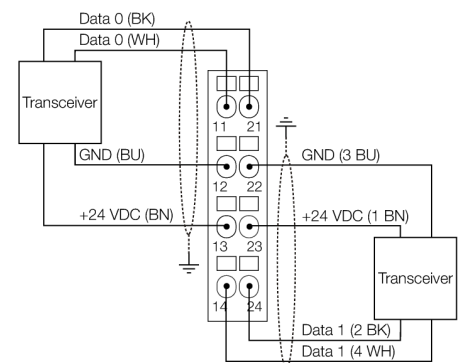

### Field supply/system supply

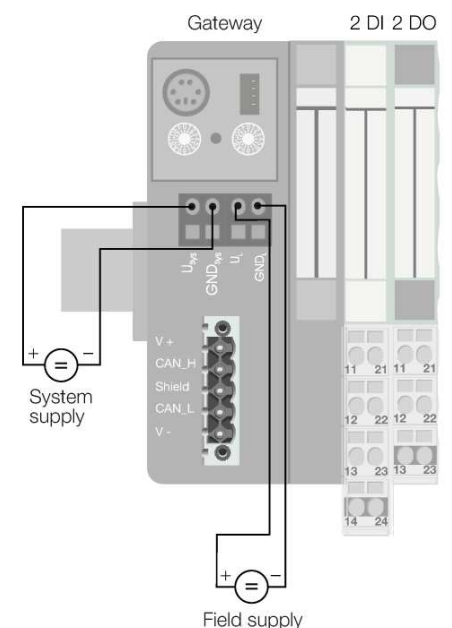

<b>Type</b>	TI-BL20-DN-S-8
Ident-No.	1545081
Number of channels	8
Dimensions (W x L x H)	110.3 x 128.9 x 74.4 mm
<b>Rated voltage from the supply terminal</b>	24 VDC
Supply voltage	24 VDC
Supply voltage	24VDC
System power supply	24 VDC / 5 VDC
Field supply	24 VDC
Admissible range	18...30 VDC
Max. field supply current	10
Max. system supply current	1.2
<b>Fieldbus transmission rate</b>	125 / 250 / 500 kbps
Fieldbus addressing range	0...63
Fieldbus addressing	2 rotary switches
Service interface	PS/2 socket for I/O-ASSISTANT
Fieldbus connection technology	open connector
Voltage supply connection	screw connection
Fieldbus termination	external
<b>Transmission rate</b>	115.2 kbps
Cable length	50m
Electrical isolation	isolation of electronics and field level via opto-couplers
<b>Connection technology</b>	Screw, tension spring
<b>Simultaneity factor</b>	1
<b>Sensor supply</b>	0.25 A per channel, short-circuit proof
<b>Number of diagnostics bytes</b>	4
Number of parameter bytes	8
<b>Operating temperature</b>	0 ... +55 °C
Storage temperature	-25 ... +85 °C
Relative humidity	5 to 95% (internal), Level RH-2, no condensation (at 45 °C storage)
Vibration test	acc. to EN 61131
Shock test	acc. to IEC 68-2-27
Drop and topple	acc. to IEC 68-2-31 and free fall to IEC 68-2-32
Electro-magnetic compatibility	acc. to EN 50,082-2
Protection class	IP20

---

**Included in scope of supply**

2 x end brackets BL20-WEW-35/2-SW, 1 x  
end plate BL20-ABPL

**Functional principle**

The BL ident® system can be installed in many different ways.

Various fieldbus standards, such as PROFIBUS-DP, EtherNet/IP, Ethernet Modbus TCP, EtherCAT, DeviceNet, CANopen and PROFINET IO allow flexible integration.

BL ident® simple electronic modules (BL20-2RFID-S, BL67-2RFID-S) can be integrated in existing control or host systems without function block, since standard input/output process data is used for communication.

Programmable gateways with peripheral pre-processing function relieve the control system and fieldbus level.

Preassembled sets (2, 4, 6 or 8-port), easily mounted, available for all fieldbus networks.

Compatible base modules

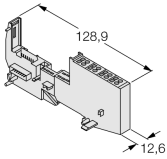
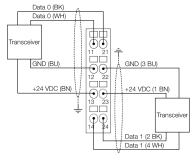
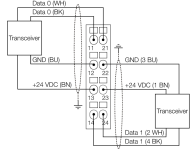
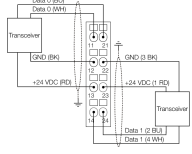
Dimension drawing	Type	Pin configuration
	<p>BL20-S4T-SBBS 6827046 tension spring connection</p> <p>BL20-S4S-SBBS 6827047 screw connection</p>	<p><b>Pin configuration</b></p> <p>Connectors .../S2500</p>  <p>Connectors .../S2501</p>  <p>Connectors .../S2503</p> 

**LED display**

LED	Color	Status	Meaning
D		OFF	Error report or diagnostics active.
	RED	ON	Failure of MODBUS communication Check if more than 2 adjacent electronic modules are pulled. Relevant modules are located between gateway and this module.
	RED	FLASHING (0.5 Hz)	Upcoming module diagnostics
RW0 / RW1		OFF	No tag, diagnostics disabled
	GREEN	ON	Tag available
	GREEN	FLASHING (2 Hz)	Data exchange with tag enabled
	RED	ON	Read/write head fault
	RED	FLASHING (2 Hz)	Short-circuit in the supply line of read/write head

**I/O Data Mapping**

Channel 0	n	DONE	BUSY	ERROR	XCVR CON	XCVR ON	TP	TFR	Reserved
	n+1	Error Code							
	n+2	Error Code 1							
	n+3	Reserved							
	n+4	READ DATA (8 Byte)							
	n+5								
	...								
	n+10								
n+11									
Channel 1	n+12	DONE	BUSY	ERROR	XCVR CON	XCVR ON	TP	TFR	Reserved
	n+13	Error Code							
	n+14	Error Code 1							
	n+15	Reserved							
	n+16	READ DATA (8 Byte)							
	n+17								
	...								
	n+22								
n+23									
<b>OUTPUT</b>	<b>BYTE</b>	<b>Bit 7</b>	<b>Bit 6</b>	<b>Bit 5</b>	<b>Bit 4</b>	<b>Bit 3</b>	<b>Bit 2</b>	<b>Bit 1</b>	<b>Bit 0</b>
Channel 0	m	XCVR	NEXT	TAG ID	READ	WRITE	TAG INFO	XCVR INFO	RESET
	m+1	Reserved					Byte Count 2	Byte Count 1	Byte Count 0
	m+2	Address high byte							
	m+3	Address low byte							
	m+4	WRITE DATA (8 Byte)							
	m+5								
	...								
	m+10								
m+11									
Channel 1	m+12	XCVR	NEXT	TAG ID	READ	WRITE	TAG INFO	XCVR INFO	RESET
	m+13	Reserved					Byte Count 2	Byte Count 1	Byte Count 0
	m+14	Address high byte							
	m+15	Address low byte							
	m+16	WRITE DATA (8 Byte)							
	m+17								
	...								
	m+22								
m+23									

**Accessories**

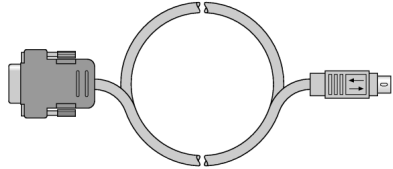
Type code	Ident-No.	Description	Dimension drawing
I/O-ASSISTANT-KA-BEL-BL20/BL67	6827133	RS232 adapter cable for the BL67/BL20 service interface	
BS3511/KLBUE4-31.5	6827342	Shield terminal and strain relief for bus cable	