

- CoDeSys-programmable acc. to IEC 61131-3
- Cable max. 50 m between interface and read/write head
- 10/100 Mbps
- LEDs for display of supply voltage, group and bus errors as well as status and diagnostics
- Connection of up to 4 read/write heads via BL ident extension cables
- Mixed operation of HF and UHF read/write heads

### Connectors .../S2500

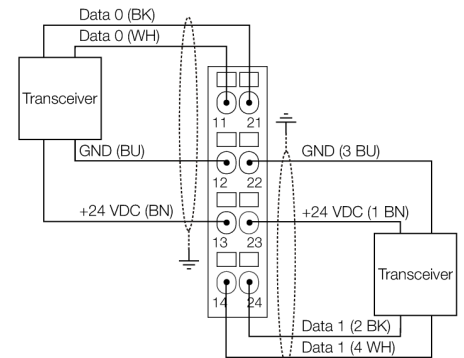

### Field supply/system supply

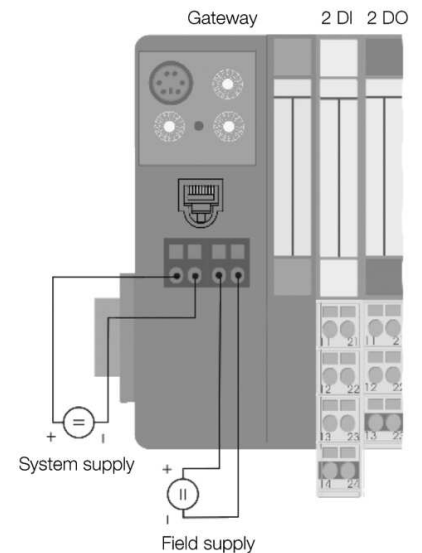

<b>Type</b>	TI-BL20-PG-EIP-4
Ident-No.	1545058
Number of channels	4
Dimensions (W x L x H)	85.1 x 128.9 x 74.4 mm
<b>Rated voltage from the supply terminal</b>	24 VDC
Supply voltage	24 VDC
Supply voltage	24VDC
System power supply	24 VDC / 5 VDC
Admissible range	18...30 VDC
Max. field supply current	10
Max. system supply current	1.2
<b>Fieldbus transmission rate</b>	10/100 Mbps
Fieldbus addressing	rotary switch, BOOTP, DHCP, IO-ASSISTANT
Service interface	PS/2 socket for I/O-ASSISTANT
Fieldbus connection technology	RJ45 socket
Voltage supply connection	screw connection
<b>PLC data</b>	
Programming	CoDeSys V2.3
Released for CoDeSys version	V 2.3.6.4
Programming languages	IEC 61131-3 (IL, LD, FBD, SFC, ST)
Application tasks	1
Number of POUs	1024
Programming interface	RS232 interface, Ethernet
Processor	RISC, 32 bit
Cycle time	< 1 ms for 1000 IL commands (without I/O cycle)
Program memory	512
Data memory	512
Input data	4
Output data	4
Non-volatile memory	16
<b>Transmission rate</b>	115.2 kbps
Cable length	50m
Electrical isolation	isolation of electronics and field level via opto-couplers
<b>Connection technology</b>	Screw, tension spring
<b>Simultaneity factor</b>	1
<b>Sensor supply</b>	0.25 A per channel, short-circuit proof

<b>Number of diagnostics bytes</b>	4
Number of parameter bytes	8
Number of input bytes	4
Number of output bytes	4
<hr/>	
<b>Operating temperature</b>	0 ... +55 °C
Storage temperature	-25 ... +85 °C
Relative humidity	5 to 95% (internal), Level RH-2, no condensation (at 45 °C storage)
Vibration test	acc. to EN 61131
Shock test	acc. to IEC 68-2-27
Drop and topple	acc. to IEC 68-2-31 and free fall to IEC 68-2-32
Electro-magnetic compatibility	acc. to EN 50,082-2
Protection class	IP20
<hr/>	
<b>Included in scope of supply</b>	2 x end brackets BL20-WEW-35/2-SW, 1 x end plate BL20-ABPL

**Functional principle**

Pin configuration i.e. signal assignment results from the combination with an electronic module. You find the pin configuration and the wiring diagrams on the data sheet of the corresponding electronic module.

The base modules are connected to the field devices via screw connections or tension spring connections.

**Note**

Further technical data, like for example the temperature range, are determined by the electronic modules and can be found on the data sheets.

BL20 electronic modules are plugged into the purely passive base modules which are used for connection of field devices. Maintenance is significantly facilitated due to separation of the connection level from the module electronics. Furthermore flexibility is enhanced because the base modules provide a choice of tension spring or screw connection technology.

The electronic modules are completely independent of the type of higher level field bus through the use of gateways.

The programmable BL20 gateways can be used as an autonomous PLC or as a decentral PLC in a network interconnection for fast signal preprocessing.

BL20 gateways are the head component of a BL20 station. The BL20 extension modules communicate over the internal module bus with the gateway and can be configured independently of the fieldbus protocol.

Compatible base modules

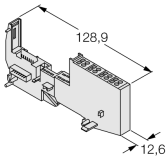
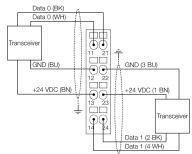
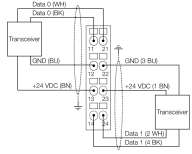
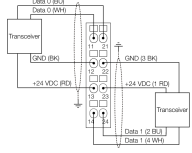
Dimension drawing	Type	Pin configuration
	<p>BL20-S4T-SBBS 6827046 tension spring connection</p> <p>BL20-S4S-SBBS 6827047 screw connection</p>	<p><b>Pin configuration</b></p> <p>Connectors .../S2500</p>  <p>Connectors .../S2501</p>  <p>Connectors .../S2503</p> 

**Compatible gateways:**

Ident	Type	Communication	Version and higher	Application
6827234	BL20-GW-DPV1	PROFIBUS-DP	FW 1.10	PLC systems with Profibus DPV1 master and PIB (Proxi Ident Block) function block. The PIB is required for the control of the RFID system and uses internally acyclic services.
6827300	BL20-GW-EN-PN	PROFINET IO	FW 1.0.0.8	PLC systems with PROFINET IO master and PIB (Proxi Ident Block) function block. The PIB is required for the control of the RFID system and uses internally acyclic services.

**Compatible CoDeSys programmable gateways**

Ident	Type	Communication	Version and higher	Application
6827250	BL20-E-GW-DP	PROFIBUS-DP	FW 1.10	PLC systems with Profibus DPV1 master and PIB (Proxi Ident Block) function block. The PIB is required for the control of the RFID system and uses internally acyclic services.

**Compatible CoDeSys programmable gateways**

Ident	Type	Communication	Version and higher	Application
6827249	BL20-PG-EN	Modbus TCP	FW 1.3.0.0	PLC systems with Modbus TCP Master or PC based solution (e.g.visualization) using a Modbus TCP driver software.
6827248	BL20-PG-EN-IP	EtherNet/IP™	FW 1.6.0.1	PLC systems with EtherNet/IP™ scanner (master). A function block is not required for the higher level PLC.

Ident	Type	Communication	Version and higher	Application
-	all PGs	Ethernet TCP/IP	FW 1.3.0.0	PC based applications with transparent Ethernet TCP/IP communication.
-	all PGs	Ethernet UDP/IP	FW 1.3.0.0	PC based applications with transparent Ethernet UDP/IP communication.
-	all PGs	OPC	FW 1.3.0.0	PC based application with OPC client. A license free CoDeSys OPC server is required.
-	all PGs	SymARTI	FW 1.3.0.0	Interchange of global network variables between CoDeSys programmable devices resp. control systems via Ethernet.
-	all PGs	DDE	FW 1.3.0.0	CoDeSys features a DDE (dynamic data exchange) interface. This way contents of control variables and IEC addresses can be exported via the DDE interface and further processed by other applications such as Excel.

**Accessories**

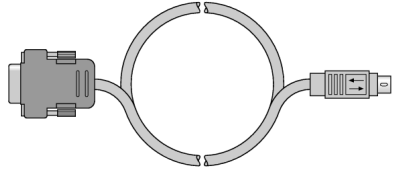
Type code	Ident-No.	Description	Dimension drawing
I/O-ASSISTANT-KA-BEL-BL20/BL67	6827133	RS232 adapter cable for the BL67/BL20 service interface	
BS3511/KLBUE4-31.5	6827342	Shield terminal and strain relief for bus cable	