

**ultrasonic sensor
diffuse mode sensor
QS18UPA**

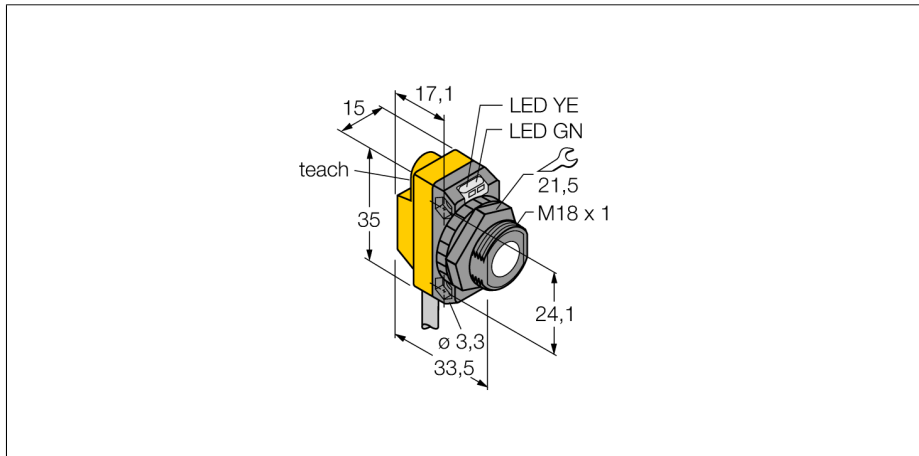

- Operating voltage 12...30 VDC
- compact housing style
- cable, 2m
- switching range adjustable via teach-in
- adjustable retro-reflective mode

Wiring diagram

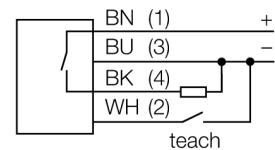

Functional principle

Ultrasonic sensors use ultrasonic waves for non-contact and wear-free detection of many objects. Regardless of whether the object is transparent or opaque, metallic or non-metallic, or of liquid, solid or powdery consistency. Even environmental conditions such as spray, dust or rain hardly affect their function.

Type code	QS18UPA
Ident no.	3073155
Design	rectangular, QS18U
Housing material	Plastic, ABS
Sonic converter material	plastic, Epoxyd resin and PU foam
Connection	cable, 2
Protection class	IP67
Ambient temperature	-20...+60 °C
Operating voltage	LED
Switching state	•
Operating voltage	12...30VDC
No-load current I ₀	≤ 25 mA
Output function	NO contact, PNP
Switching frequency	33 Hz
Hysteresis	≤ 1.4 mm
Short-circuit protection	yes
Reverse polarity protection	complete
Wire breakage protection	yes
Range	5...50 cm
Ultrasound frequency	300 kHz
Repeatability	≥ ± 0.7 mm
Edge lengths of the nominal actuator	50 mm

ultrasonic sensor
diffuse mode sensor
QS18UPA

TURCK

Industrial
Automation

Accessories

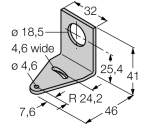
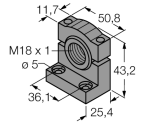
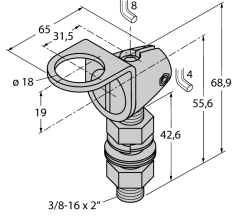
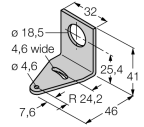
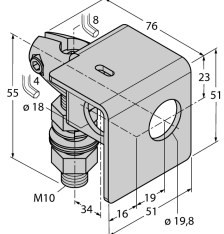
Type code	Ident no.	Description	Dimension drawing
SMB18A	3470200	Mounting bracket, stainless steel, for sensors with 18 mm thread	
SMB18SF	3052519	Mounting bracket, PTB black steel, for sensors with 18 mm thread	
SMB18FA	3074004	Mounting bracket; material VA 1.4401, for 18 mm thread	
SMB18FM	3079421	mounting bracket, black, M22 x1.5 mm, male thread, female thread M18 x 1, for sensors with 18 mm thread	
SMB18UR	3052517		
SMB18A	3033200	Mounting bracket, stainless steel, for sensors with 18 mm thread	
SMB18AFAM10	3012558	Mounting bracket, material VA 1.4401, for M10 x 1.5 thread, thread length 18 mm	

ultrasonic sensor
diffuse mode sensor
QS18UPA

TURCK

Industrial
Automation

Function accessories

Type code	Ident no.	Description	Dimension drawing
UWG18-6.4	3076952	Ultrasonic focussing-adapter for QS18U and S18U, internal diameter 6.4 mm	
UWG18-5.0	3077342	Ultrasonic focussing-adapter for QS18U and S18U, internal diameter 5.0 mm	
VB2-SP2	6999083	Teach adapter for ultrasonic sensors, types RUN and RUR	