

**Temperature measurement
Probe
TP-206A-CF-H1141-L200**

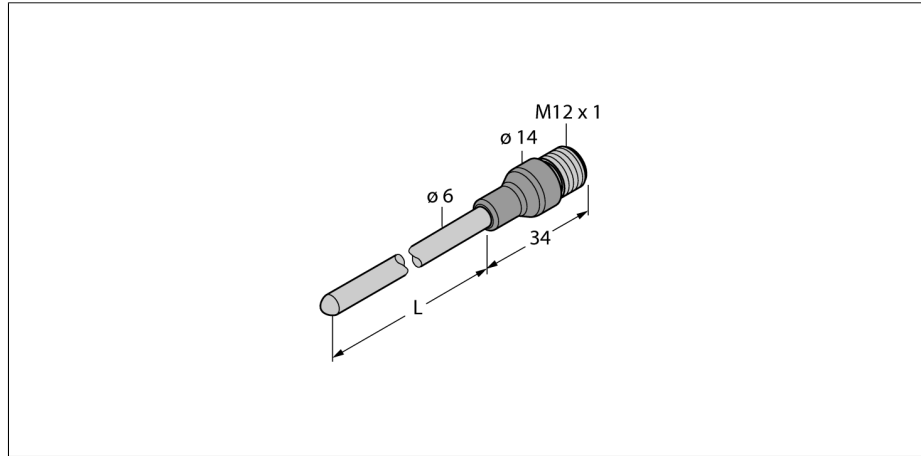

- Pt-100 probe acc. to DIN EN 60751
- Vibration and shock-resistant
- Connectable to TS, TTM, IM34, BL20, BL67
- Temperature range -50...500 °C
- 4-wire technology

Wiring diagram

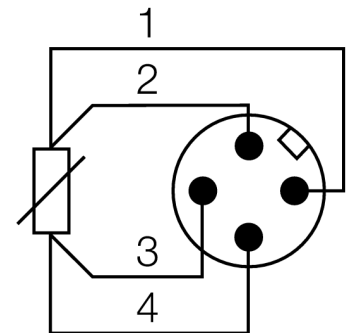

General description

Resistance thermometers come into operation when temperatures must be measured and monitored to control and optimize processes.

Typical applications are process plants, manufacturing facilities and units, as well as air-conditioning systems. The core element of the temperature sensors is a Pt 100 measuring resistor in 4-wire technology.

Type code	TP-206A-CF-H1141-L200
Ident no.	9910477
Temperature operating range	-50...500 °C
Measuring element	Pt-100 platinum measuring element, DIN EN 60751
Accuracy	Class A
Response time	t0.5 = 6 s / t0.9 = 15 s in water at @ 0.2 m/s
Immersion depth (L)	200 mm
Protection type and class	IP67
MTTF	2283 years acc. to SN 29500 (Ed. 99) 40 °C
Ambient conditions	
Ambient temperature	-40 ... 120 °C
Storage temperature	-40...+85°C
Pressure resistance	100 bar
Housing	
Housing material	Stainless steel/plastic, V4A (1.4404)
Sensor material	stainless steel, AISI 316L
Mechanical connection	for compression ferrule fittings, protective tubing or direct mounting
Connection	male, M12 x 1
Pressure resistance	100 bar
Reference conditions acc. to IEC 61298-1	
temperature	15...25 °C
Atmospheric pressure	860...1060 hPa abs.
Humidity	45...75 % rel.
Auxiliary power	24 VDC

**Temperature measurement
Probe
TP-206A-CF-H1141-L200**

Accessories

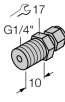
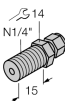
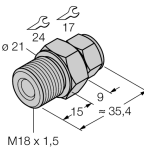
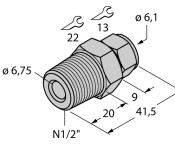
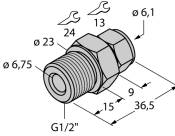
Type code	Ident no.	Description	Dimension drawing
CF-M-6-G1/4-A4	9910483	Compression ferrule fittings for direct mounting of temperature probes	
CF-M-6-N1/4-A4	9910484	Compression ferrule fittings for direct mounting of temperature probes	
CF-M-6-M18-A4	9910525	Compression ferrule fittings for direct mounting of temperature probes	
CF-M-6-N1/2-A4	9910529	Compression ferrule fittings for direct mounting of temperature probes	
CF-M-6-G1/2-A4	9910530	Compression ferrule fittings for direct mounting of temperature probes	

**Temperature measurement
Probe
TP-206A-CF-H1141-L200**

Wiring accessories

Type code	Ident no.	Description	Dimension drawing
RKC4.4T-2/TEL	6625013	Connection cable, female M12, straight, 4-pin, cable length: 2 m, sheath material: PVC, black; cULus approval; other cable lengths and qualities available, see www.turck.com	
WKC4.4T-2/TEL	6625025	Connection cable, female M12, angled, 4-pin, cable length: 2 m, sheath material: PVC, black; cULus approval; other cable lengths and qualities available, see www.turck.com	
RKC4.4T-2/TXL	6625503	Connection cable, female M12, straight, 4-pin, cable length: 2 m, sheath material: PVC, black; cULus approval; other cable lengths and qualities available, see www.turck.com	
WKC4.4T-2/TXL	6625515	Connection cable, female M12, angled, 4-pin, cable length: 2 m, sheath material: PVC, black; cULus approval; other cable lengths and qualities available, see www.turck.com	