

**Magnetic field sensor
magnet-inductive proximity sensor
BIM-EM12E-Y1X**

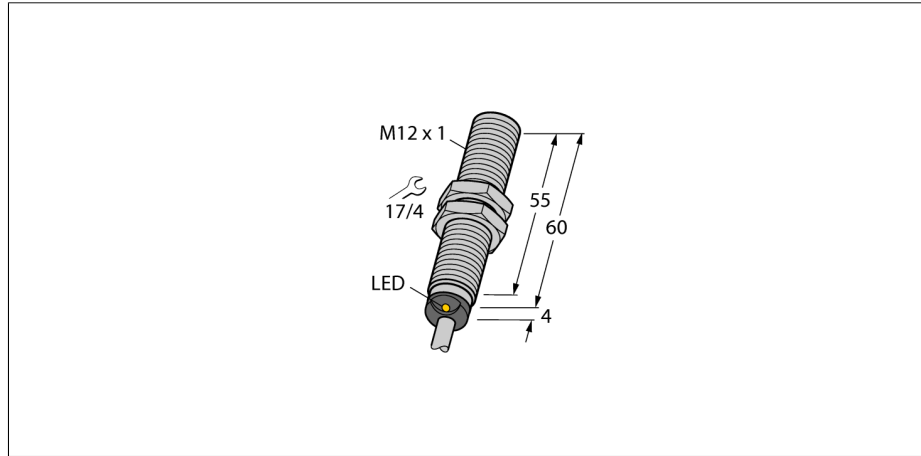

- ATEX category II 1 G, Ex zone 0
- ATEX category II 1 D, Ex zone 20
- SIL2 as per IEC 61508
- Threaded barrel, M12 x 1
- Stainless steel, 1.4301
- Rated operating distance 90 mm with DMR31-15-5 magnet
- DC 2-wire, nom. 8.2 VDC
- Output acc. to DIN EN 60947-5-6 (NAMUR)
- Cable connection

Wiring diagram

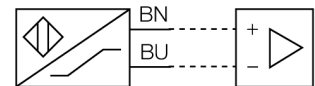

Functional principle

Magnetic inductive proximity sensors are actuated by magnetic fields and are thus capable of detecting permanent magnets through non-ferromagnetic materials (e.g. wood, plastic, non-ferrous metals, aluminium, stainless steel).

Thus it is possible to achieve large switching distances even with smaller housing styles. In combination with the actuation magnet DMR31-15-5 TURCK sensors feature a relatively high switching distance. Thus there are multiple detection possibilities, particularly if the mounting space is limited or other difficult sensing conditions prevail.

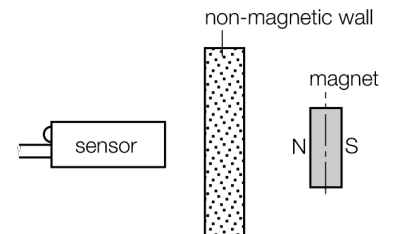

Type code	BIM-EM12E-Y1X
Ident no.	1070036
Rated operating distance Sn	90 mm in conjunction with magnet DMR31-15-5
Repeatability	≤ 0.3 % of full scale
Temperaturdrift	15 %
Hysteresis	1...10 %
Ambient temperature	-25...+70 °C
Output function	2-wire, NAMUR
Switching frequency	1 kHz
Voltage	Nom. 8.2 VDC
Non-actuated current consumption	≤ 1.2 mA
Actuated current consumption	≥ 2.1 mA
Approval acc. to	KEMA 02 ATEX 1090X
Internal capacitance (C.) / inductance (L.)	150 nF / 150 µH
Device designation	Ⓢ II 1 G Ex ia IIC T6/II 1 D Ex ia D 20 T115 °C (max. U _i = 20 V, I _i = 60 mA, P _i = 200 mW)
Design	threaded barrel, M12 x 1
Dimensions	64 mm
Housing material	Metal, V2A (1.4301)
Material active face	Plastic, POM
End cap	Plastic, EPTR
Max. tightening torque housing nut	10 Nm
Connection	cable
Cable quality	5.2 mm, blue, LifYY, PVC, 2 m
Cable cross section	2 x 0.34 mm ²
Vibration resistance	55 Hz (1 mm)
Shock resistance	30 g (11 ms)
Protection class	IP67
MTTF	6198 years acc. to SN 29500 (Ed. 99) 40 °C
Switching state	● yellow
Diameter of the active area B	Ø 12 mm

**Magnetic field sensor
magnet-inductive proximity sensor
BIM-EM12E-Y1X**

Accessories

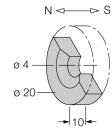
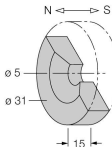
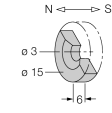
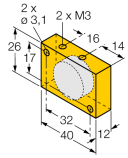
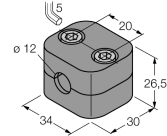
Type code	Ident no.	Description	Dimension drawing
DMR20-10-4	6900214	Actuation magnet; Ø 20 mm (Ø 4 mm), h: 10 mm; sensing range 59 mm on BIM-(E)M12 sensors resp. 50 mm on BIM-EG08 sensors; in combination with Q25L: Recommended distance between sensor and magnet: 3 ... 4 mm	
DMR31-15-5	6900215	Actuation magnet, Ø 31 mm (Ø 5 mm), h: 15 mm; sensing range 90 mm on BIM-(E)M12 sensors resp. 78 mm on BIM-EG08 sensors; in combination with Q25L: Recommended distance between sensor and magnet: 3 ... 5 mm	
DMR15-6-3	6900216	Actuation magnet, Ø 15 mm (Ø 3 mm), h: 6 mm; sensing range 36 mm on BIM-(E)M12 sensors resp. 32 mm on BIM-EG08 sensors; in combination with Q25L: Recommended distance between sensor and magnet: 3 ... 4 mm	
DM-Q12	6900367	Actuation magnet; cuboid-shaped plastic; sensing range 58 mm on BIM-(E)M12 sensors resp. 49 mm on BIM-EG08 sensors; in combination with Q25: Recommended distance between sensor and magnet: 3 ... 5 mm	
BSS-12	6901321	Mounting bracket for smooth and threaded barrel devices; material: Polypropylene	

**Magnetic field sensor
magnet-inductive proximity sensor
BIM-EM12E-Y1X**

Accessories

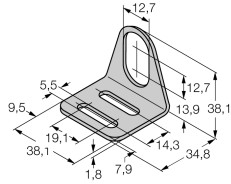
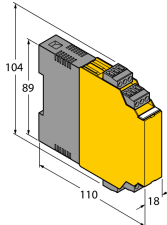
Type code	Ident no.	Description	Dimension drawing
MW-12	6945003	Mounting bracket for threaded barrel devices; material: Stainless steel A2 1.4301 (AISI 304)	
IM1-22EX-R	7541231	Isolating switching amplifier, dual-channel; 2 relay outputs NO; input NAMUR signal; selectable ON/OFF mode for wire-break and short-circuit monitoring; adjustable signal flow (NO/ NC mode); removable terminal blocks; 18 mm width; universal voltage supply unit	

Magnetic field sensor magnet-inductive proximity sensor BIM-EM12E-Y1X

TURCK

Industrial
Automation

Operating manual

Intended use

This device fulfills the directive 94/9/EC and is suited for use in explosion hazardous areas according to EN60079-0:2009, -11:2007, -26:2007. Further it is suited for use in safety-related systems, including SIL2 as per IEC 61508.

In order to ensure correct operation to the intended purpose it is required to observe the national regulations and directives.

For use in explosion hazardous areas conform to classification

II 1 G and II 1 D (Group II, Category 1 G, electrical equipment for gaseous atmospheres and category 1 D, electrical equipment for dust atmospheres).

Marking (see device or technical data sheet)

Ex II 1 G and Ex ia IIC T6 acc. to EN60079-0 and -26 and Ex II 1 D Ex ia IIIC IP67 T95 °C acc. to EN60079-0

Local admissible ambient temperature

-25...+70 °C

Installation / Commissioning

These devices may only be installed, connected and operated by trained and qualified staff. Qualified staff must have knowledge of protection classes, directives and regulations concerning electrical equipment designed for use in explosion hazardous areas.

Please verify that the classification and the marking on the device comply with the actual application conditions.

This device is only suited for connection to approved Exi circuits compliant to EN60079-0 and -11. Please observe the maximum admissible electrical values.

After connection to other circuits the sensor may no longer be used in Exi installations. When interconnected to (associated) electrical equipment, it is required to perform the "Proof of intrinsic safety" (EN60079-14).

When employed in safety systems to IEC 51408 it is required to assess the failure probability (PFD) of the complete circuitry.

Installation and mounting instructions

Avoid static charging of cables and plastic devices. Please only clean the device with a damp cloth. Do not install the device in a dust flow and avoid build-up of dust deposits on the device.

If the devices and the cable could be subject to mechanical damage, they must be protected accordingly. They must also be shielded against strong electro-magnetic fields.

The pin configuration and the electrical specifications can be taken from the device marking or the technical data sheet.

service / maintenance

Repairs are not possible. The approval expires if the device is repaired or modified by a person other than the manufacturer. The most important data from the approval are listed.