

EZ- LIGHT® Touch K50 Series Pick to Light



Compact, Single-Point Devices for Error-Proofing of Bin-Picking Operations

For the latest technical information about this product, including specifications, dimensions, and wiring, see www.BannerEngineering.com

Features

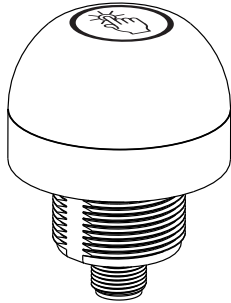

- Rugged, cost-effective and easy-to-install solutions for error-proofing and parts-verification applications
- Compact devices are completely self contained - No controller needed
- Illuminated dome provides an easy-to-see green job light: some models also light red for alternate operation
- Waterproof IP69K construction for washdown environments
- Easy actuation - No force required
- 12 to 30V dc operation
- Can be actuated with bare hands or in gloves

Models

Model*	Function	Output	Connection	Job Light		
K50APTGXEQ	<ul style="list-style-type: none"> • Job light is ON at all times while job input is active • Touch activates output 	PNP, NO	Integral 4-pin Euro QD	Green		
K50RPTGXEQ		PNP, NC				
K50ANTGXEQ		NPN, NO				
K50RNTGXEQ		NPN, NC				
K50APTGRCEQ	<ul style="list-style-type: none"> • Job light is Green while job input is active • Touch activates output and overrides job light (turns Red) for visual verification that action was sensed 	PNP, NO		Integral 4-pin Euro QD	Green (Red)	
K50RPTGRCEQ		PNP, NC				
K50ANTGRCEQ		NPN, NO				
K50RNTGRCEQ		NPN, NC				
K50APTRGEQ	<ul style="list-style-type: none"> • Job light is Green at all times while job input is active • Touch activates output • A touch while job input is inactive causes unit to light Red, providing visual verification that sensor is functioning properly 	PNP, NO			Integral 4-pin Euro QD	Green (Red)
K50RPTRGEQ		PNP, NC				
K50ANTRGEQ		NPN, NO				
K50RNTRGEQ		NPN, NC				

* Integral QD models are listed. For 2 m (6.5') PVC cable, omit suffix Q from model number (example, K50APTRGXEQ). A model with a QD requires a mating cable (see [Quick-Disconnect \(QD\) Cordsets](#)).



WARNING: Not To Be Used for Personnel Protection

Never use this product as a sensing device for personnel protection. Doing so could lead to serious injury or death. This product does NOT include the self-checking redundant circuitry necessary to allow its use in personnel safety applications. A sensor failure or malfunction can cause either an energized or de-energized sensor output condition.

Dimensions

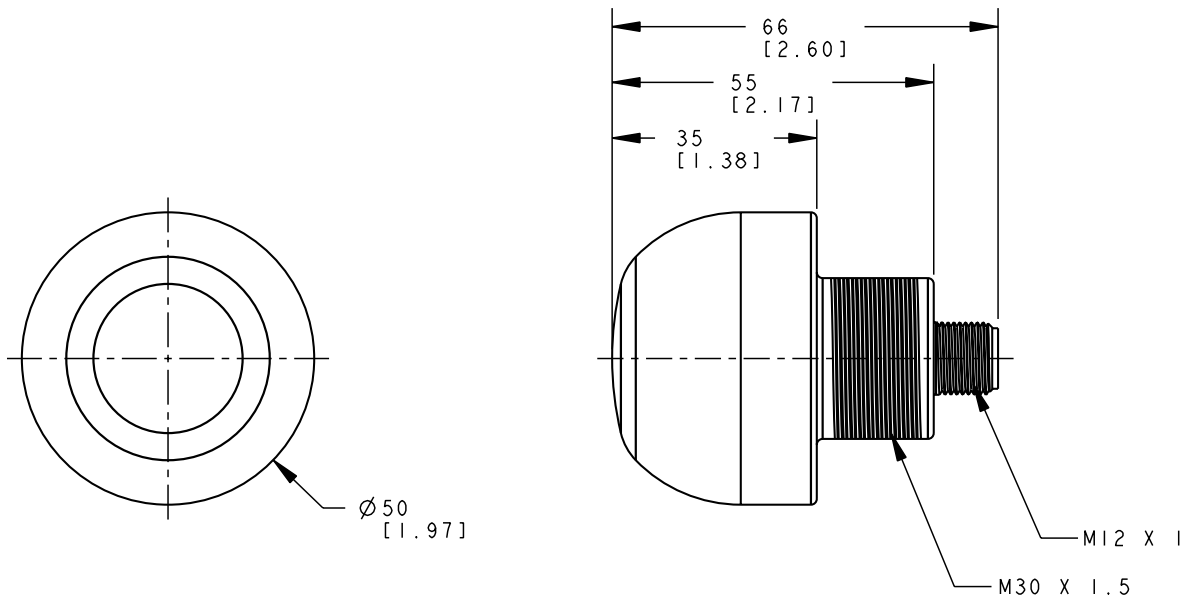

Hookups

NPN

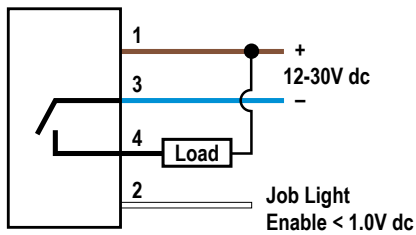

PNP

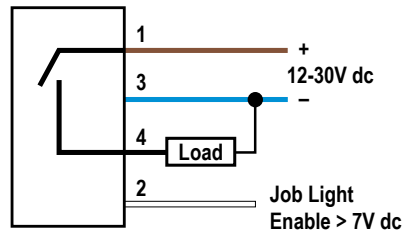

Color Key

- 1 = Brown
- 2 = White
- 3 = Blue
- 4 = Black

Specifications

Supply Voltage

12 to 30V dc

Supply Current

Less than 75 mA max current at 12V dc (exclusive of load)

Less than 40 mA max current at 30V dc (exclusive of load)

Supply Protection Circuitry

Protected against reverse polarity and transient voltages

Output Rating

Maximum Load: 150 mA

ON-state saturation voltage: < 2V at 10 mA dc; < 2.5V at 150 mA dc

OFF-state leakage current: <10 µA @ 30V dc

Indicators

Job ("Pick") Indicator: Green

Pick Sensed Indicator: Red or OFF, depending on model

Output Response Time:

50 milliseconds ON and OFF

Connections

Integral 4-pin Euro style QD, or 2m (6.5') PVC integral cable

Environmental Rating

IEC IP67, IP69K per DIN 40050-9. Cabled models also meet IP69K if the cable and cable entrance are protected from high-pressure spray.

Operating Conditions

Temperature: -40° to +50° C (-40° to +122° F)

Humidity: 90% @ 50° C max. relative humidity (non-condensing)

Storage

-40° to +70° C (-40° to +158° F)

Construction

Housing: polycarbonate

Translucent dome: polycarbonate

Mounting Nut: PBT

Mounting

M30 x 1.5 Threaded base Max torque 4.5 Nm (40in lb f)

Vibration and Mechanical Shock

All models meet Mil. Std. 202F requirements method 201A (vibration: 10 to 60 Hz max., double amplitude 0.06", maximum acceleration 10G). Also meets IEC 947-5-2; 30G 11 ms duration, half sine wave.







Certifications



Quick-Disconnect (QD) Cordsets

Style	Model	Length	Dimensions	Pinout (Female)
4-Pin Euro-Style Straight	MQDC-406	2 m (6.5')		
	MQDC-415	5 m (15')		
	MQDC-430	9 m (30')		
4-Pin Euro-Style Right-Angle	MQDC-406RA	2 m (6.5')		<p>1= Brown 2= White 3= Blue 4= Black</p>
	MQDC-415RA	5 m (15')		
	MQDC-430RA	9 m (30')		

Mounting Brackets

<p>SMB30A</p> <ul style="list-style-type: none"> • Right-angle bracket with curved slot for versatile orientation • Clearance for M6 (1/4") hardware • Mounting hole for 30 mm sensor • 12-ga. stainless steel 	<p>SMB30FA</p> <ul style="list-style-type: none"> • Swivel bracket with tilt and pan movement for precise adjustment • Mounting hole for 30 mm sensor • 12-ga. 304 stainless steel • Easy sensor mounting to extrude rail T-slot 
<p>SMB30FVK</p> <ul style="list-style-type: none"> • V-clamp, flat bracket and fasteners for mounting to pipe or extensions • Clamp accommodates 28 mm dia. tubing or 1" square extrusions • 30 mm hole for mounting sensors 	<p>SMB30MM</p> <ul style="list-style-type: none"> • 12-ga. stainless steel bracket with curved mounting slots for versatile orientation • Clearance for M6 (1/4") hardware • Mounting hole for 30 mm sensor 
<p>SMB30RAVK</p> <ul style="list-style-type: none"> • V-clamp, right-angle bracket and fasteners for mounting sensors to pipe or extrusion • Clamp accommodates 28 mm dia. tubing or 1" square extrusions • 30 mm hole for mounting sensors 	<p>SMB30SC</p> <ul style="list-style-type: none"> • Swivel bracket with 30 mm mounting hole • Black reinforced thermoplastic polyester • Stainless steel mounting and swivel locking hardware included 

Banner Engineering Corp Limited Warranty

Banner Engineering Corp. warrants its products to be free from defects in material and workmanship for one year following the date of shipment. Banner Engineering Corp. will repair or replace, free of charge, any product of its manufacture which, at the time it is returned to the factory, is found to have been defective during the warranty period. This warranty does not cover damage or liability for misuse, abuse, or the improper application or installation of the Banner product.

THIS LIMITED WARRANTY IS EXCLUSIVE AND IN LIEU OF ALL OTHER WARRANTIES WHETHER EXPRESS OR IMPLIED (INCLUDING, WITHOUT LIMITATION, ANY WARRANTY OF MERCHANTABILITY OR FITNESS FOR A PARTICULAR PURPOSE), AND WHETHER ARISING UNDER COURSE OF PERFORMANCE, COURSE OF DEALING OR TRADE USAGE.

This Warranty is exclusive and limited to repair or, at the discretion of Banner Engineering Corp., replacement. **IN NO EVENT SHALL BANNER ENGINEERING CORP. BE LIABLE TO BUYER OR ANY OTHER PERSON OR ENTITY FOR ANY EXTRA COSTS, EXPENSES, LOSSES, LOSS OF PROFITS, OR ANY INCIDENTAL, CONSEQUENTIAL OR SPECIAL DAMAGES RESULTING FROM ANY PRODUCT DEFECT OR FROM THE USE OR INABILITY TO USE THE PRODUCT, WHETHER ARISING IN CONTRACT OR WARRANTY, STATUTE, TORT, STRICT LIABILITY, NEGLIGENCE, OR OTHERWISE.**

Banner Engineering Corp. reserves the right to change, modify or improve the design of the product without assuming any obligations or liabilities relating to any product previously manufactured by Banner Engineering Corp.