

EZ-LIGHT® Touch K50 Series Illuminated Buttons



more sensors, more solutions

Lighted Touch Button with Bipolar Outputs

For the latest technical information about this product, including specifications, dimensions, and wiring, see <http://www.bannerengineering.com>

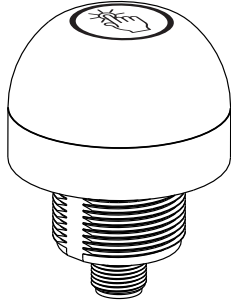

- Rugged, cost-effective, and easy-to-install touch button with multicolor light
- Momentary versions remain activated as long as touch is present
- Latching versions start up not activated and toggle between activated and not activated on successive touches
- Waterproof IP69K construction for washdown environments
- Ergonomically designed to eliminate hand, wrist, and arm stresses associated with repeated switch operation; require no physical pressure to operate
- Can be actuated with bare hands or in gloves
- 12 to 30V dc operation

Models

Model ¹	Function	Output	Light (not activated)	Light (activated)	Connection		
K50ALBTXGHQ	Latching	Bipolar, N.O.	-	Green	Integral 5-pin Euro QD		
K50RLBTXGHQ		Bipolar, N.C.					
K50ABTXGHQ	Momentary	Bipolar, N.O.					
K50RBTXGHQ		Bipolar, N.C.					
K50ALBTGGHQ	Latching	Bipolar, N.O.				Green	Green
K50RLBTGGHQ		Bipolar, N.C.					
K50ABTGGHQ	Momentary	Bipolar, N.O.					
K50RBTGGHQ		Bipolar, N.C.					
K50ALBTRGHQ	Latching	Bipolar, N.O.	Red	Green			
K50RLBTRGHQ		Bipolar, N.C.					
K50ABTRGHQ	Momentary	Bipolar, N.O.					
K50RBTRGHQ		Bipolar, N.C.					



WARNING: Not To Be Used for Personnel Protection

Never use this device as a sensing device for personnel protection. Doing so could lead to serious injury or death. This device does NOT include the self-checking redundant circuitry necessary to allow its use in personnel safety applications. A sensor failure or malfunction can cause either an energized or de-energized sensor output condition.

¹ 5-pin integral QD models only are listed.

- For 5-pin 150 mm (5.9 in) Eurostyle PVC pigtail, replace suffix Q with QP in model number (example, K50ALBTXGHQP).
- For 2 m (6.5 ft) cable, omit suffix Q from model number (example, K50ALBTXGH).
- A model with a QD requires a mating cable (see [Cordsels](#) on page 3).



Dimensions

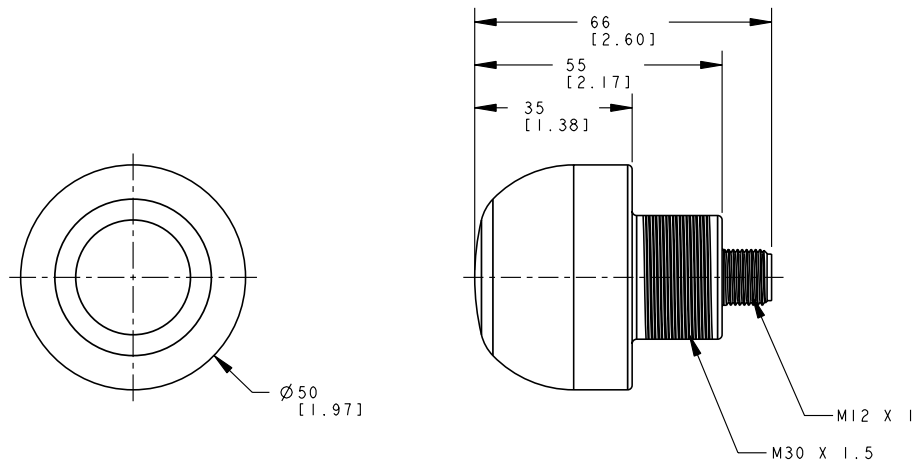

Wiring

Bipolar

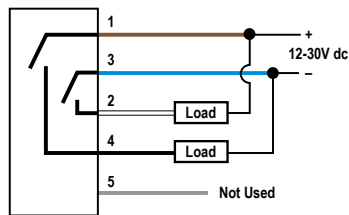

Color Key:

- 1 = Brown
- 2 = White
- 3 = Blue
- 4 = Black
- 5 = Gray

Specifications

Supply Voltage

12 to 30V dc

Supply Current

< 75 mA max current at 12V dc (exclusive of load)

< 50 mA max current at 30V dc (exclusive of load)

Supply Protection Circuitry

Protected against reverse polarity and transient voltages

Output Rating

Maximum Load: 150 mA

ON-state saturation voltage: < 2V at 10 mA dc; < 2.5V at 150 mA dc

OFF-state leakage current < 10 μ A at 30V dc

Output Response Time

Momentary models: 50 milliseconds ON and OFF

Latching models: 150 milliseconds ON and OFF

Power-Up

Device requires 300 milliseconds to start up

Latching models startup in not activated state

Connections

5-pin integral Euro-style QD, 2 m (6.5 ft) PVC integral cable, or 5-pin

150 mm (5.9 in) Euro-style PVC pigtail QD

Environmental Rating

IEC IP67, IP69K per DIN 40050-9. Cabled models also meet IP69K if the cable and cable entrance are protected from high-pressure spray.

Operating Conditions

Temperature: -40° to +50° C (-40° to +122° F)

Humidity: 90% at 50° C max. relative humidity (non-condensing)

Storage

-40° to +70° C (-40° to +158° F)

Construction

Housing: polycarbonate

Translucent dome: polycarbonate

Mounting Nut: PBT

Mounting

M30 x 1.5 Threaded base Max torque 4.5 Nm (40in lb f)

Vibration and Mechanical Shock

All models meet Mil. Std. 202F requirements method 201A (vibration: 10 to 60 Hz max., double amplitude 0.06 in. maximum acceleration 10G). Also meets IEC 947-5-2; 30G 11 ms duration, half sine wave.

Certifications



Accessories

Cordsets

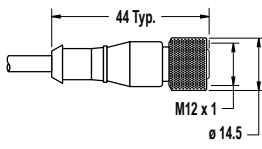
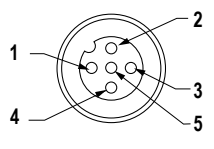
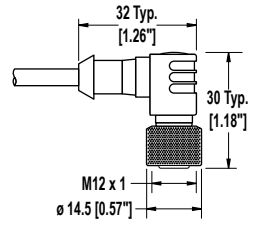
5-Pin Threaded M12/Euro-Style Cordsets				
Model	Length	Style	Dimensions	Pinout
MQDC1-501.5	0.50 m (1.5 ft)	Straight		 <p>1 = Brown 2 = White 3 = Blue 4 = Black 5 = Gray</p>
MQDC1-506	1.83 m (6 ft)			
MQDC1-515	4.57 m (15 ft)			
MQDC1-530	9.14 m (30 ft)			
MQDC1-506RA	1.83 m (6 ft)	Right-Angle		
MQDC1-515RA	4.57 m (15 ft)			
MQDC1-530RA	9.14 m (30 ft)			

Brackets

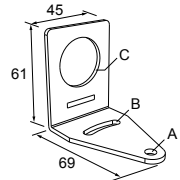
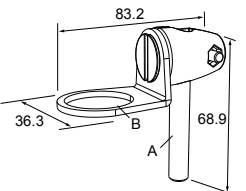
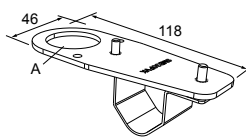
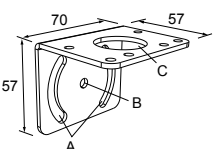
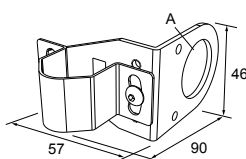
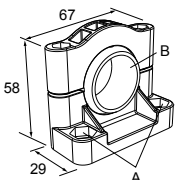
<p>SMB30A</p> <ul style="list-style-type: none"> • Right-angle bracket with curved slot for versatile orientation • Clearance for M6 (¼ in) hardware • Mounting hole for 30 mm sensor • 12-ga. stainless steel  <p>Hole center spacing: A to B=40 Hole size: A=ø 6.3, B= 27.1 x 6.3, C=ø 30.5</p>	<p>SMB30FA</p> <ul style="list-style-type: none"> • Swivel bracket with tilt and pan movement for precise adjustment • Mounting hole for 30 mm sensor • 12-ga. 304 stainless steel • Easy sensor mounting to extrude rail T-slot • Metric and inch size bolt available  <p>Bolt thread: SMB30FA, A= 3/8 - 16 x 2 in; SMB30FAM10, A= M10 - 1.5 x 50 Hole size: B= ø 30.1</p>
<p>SMB30FVK</p> <ul style="list-style-type: none"> • V-clamp, flat bracket and fasteners for mounting to pipe or extensions • Clamp accommodates 28 mm dia. tubing or 1 in. square extrusions • 30 mm hole for mounting sensors  <p>Hole size: A= ø 31</p>	<p>SMB30MM</p> <ul style="list-style-type: none"> • 12-ga. stainless steel bracket with curved mounting slots for versatile orientation • Clearance for M6 (¼ in) hardware • Mounting hole for 30 mm sensor  <p>Hole center spacing: A = 51, A to B = 25.4 Hole size: A = 42.6 x 7, B = ø 6.4, C = ø 30.1</p>
<p>SMB30RAVK</p> <ul style="list-style-type: none"> • V-clamp, right-angle bracket and fasteners for mounting sensors to pipe or extrusion • Clamp accommodates 28 mm dia. tubing or 1 in. square extrusions • 30 mm hole for mounting sensors  <p>Hole size: A = ø 30.5</p>	<p>SMB30SC</p> <ul style="list-style-type: none"> • Swivel bracket with 30 mm mounting hole for sensor • Black reinforced thermoplastic polyester • Stainless steel mounting and swivel locking hardware included  <p>Hole center spacing: A=ø 50.8 Hole size: A=ø 7.0, B=ø 30.0</p>

SMBAMS30P

- Flat SMBAMS series bracket
- 30 mm hole for mounting sensors
- Articulation slots for 90+° rotation
- 12-ga. 300 series stainless steel

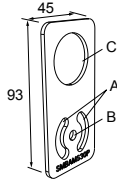

Hole center spacing: A=26.0, A to B=13.0
Hole size: A=26.8 x 7.0, B=∅ 6.5, C=∅ 31.0

SMBAMS30RA

- Right-angle SMBAMS series bracket
- 30 mm hole for mounting sensors
- Articulation slots for 90+° rotation
- 12-ga. (2.6 mm) cold-rolled steel

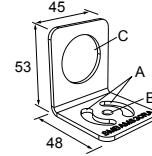

Hole center spacing: A=26.0, A to B=13.0
Hole size: A=26.8 x 7.0, B=∅ 6.5, C=∅ 31.0

Banner Engineering Corp Limited Warranty

Banner Engineering Corp. warrants its products to be free from defects in material and workmanship for one year following the date of shipment. Banner Engineering Corp. will repair or replace, free of charge, any product of its manufacture which, at the time it is returned to the factory, is found to have been defective during the warranty period. This warranty does not cover damage or liability for misuse, abuse, or the improper application or installation of the Banner product.

THIS LIMITED WARRANTY IS EXCLUSIVE AND IN LIEU OF ALL OTHER WARRANTIES WHETHER EXPRESS OR IMPLIED (INCLUDING, WITHOUT LIMITATION, ANY WARRANTY OF MERCHANTABILITY OR FITNESS FOR A PARTICULAR PURPOSE), AND WHETHER ARISING UNDER COURSE OF PERFORMANCE, COURSE OF DEALING OR TRADE USAGE.

This Warranty is exclusive and limited to repair or, at the discretion of Banner Engineering Corp., replacement. **IN NO EVENT SHALL BANNER ENGINEERING CORP. BE LIABLE TO BUYER OR ANY OTHER PERSON OR ENTITY FOR ANY EXTRA COSTS, EXPENSES, LOSSES, LOSS OF PROFITS, OR ANY INCIDENTAL, CONSEQUENTIAL OR SPECIAL DAMAGES RESULTING FROM ANY PRODUCT DEFECT OR FROM THE USE OR INABILITY TO USE THE PRODUCT, WHETHER ARISING IN CONTRACT OR WARRANTY, STATUTE, TORT, STRICT LIABILITY, NEGLIGENCE, OR OTHERWISE.**

Banner Engineering Corp. reserves the right to change, modify or improve the design of the product without assuming any obligations or liabilities relating to any product previously manufactured by Banner Engineering Corp.



more sensors, more solutions