

**2 port junction systems**

**Y junction female M12 x 1 connector - 2 male M12 x 1 connectors**  
**FKM4-2WAS3-1/1/P00**

- **robust and pre-assembled Y junction**
- **Degree of protection IP67**
- **also available with different cable lengths and of different materials**
- **PVC cable**

**Wiring diagram**

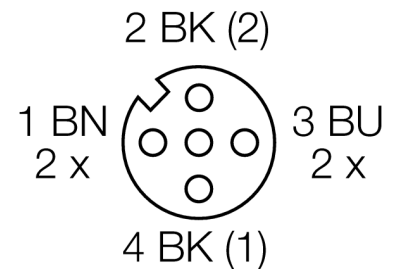

**Cable quality P00**

This pure PVC cable with PVC cable jacket and conductor insulation is resistant to average mechanical strain and suited for use in tooling and packaging machinery as well as assembly and production lines.

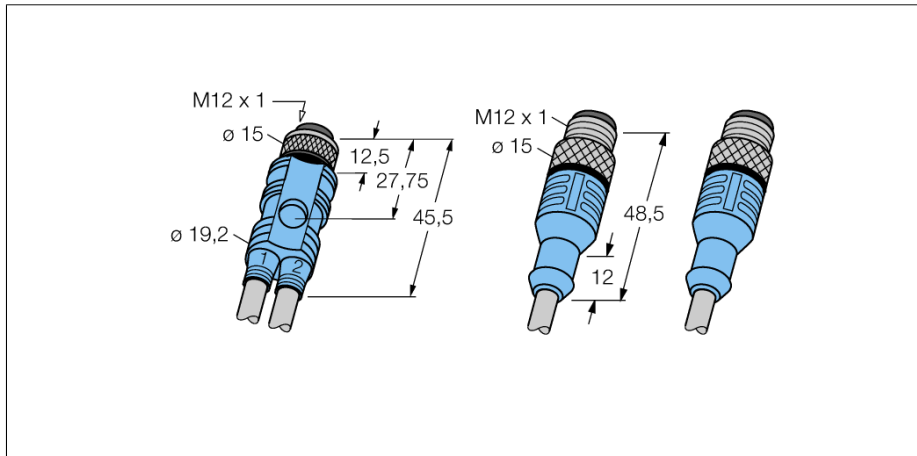
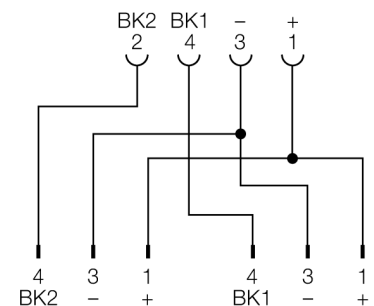

<b>Type code</b>	FKM4-2WAS3-1/1/P00
Ident no.	8009622
<b>Junction box</b>	Y-piece, with cable
Number of pins	4/3
Connector B side	female connector, 1x, M12 x 1, straight
Number of pins	3
Grip	plastic, TPU, blue
Contact carriers	plastic, TPU, black
Contacts	metal, CuZn, gold-plated
Coupling nut/screw	metal, CuZn, nickel-plated
Seal	plastic, FPM/FKM
Protection class	IP67, (plugged)
Mechanical lifespan	> 100 mating cycles
Pollution degree	3
<b>Connector</b>	Connector, 2x, M12 x 1
Polarity	3-pole
Grip	plastic, TPU, blue
Contact carriers	plastic, TPU, black
Contacts	metal, CuZn, gold-plated
Coupling nut/screw	metal, CuZn, nickel-plated
Protection class	IP67, only when plugged in
Mechanical lifespan	> 100 contact durability
Pollution degree	3/2
<b>Cable</b>	P00, LifYY, 5.2
Cable length	1/ 1m
Cable sheath	PVC, GY
Core insulation	PVC
Core colors	BN, BU, BK
Core cross-section	4x0.34mm <sup>2</sup>
Litz wire arrangement	43x0.1 mm
Bending radius (mobile)	min. 10 x Ø cable
<b>Rated voltage [Umax]</b>	250 V
Ampacity	4 A
Forward resistance	≤ 5 mΩ
Insulation resistance	≥ 10 <sup>8</sup> Ω
Ambient temperature junction	-30 ... +90°C
Cable ambient temperature	-40... +80°C