

**Passive actuator/sensor junction box, M12 x 1
4-port, with integral homerun cable
TB-4M12-5-5/TXL**

- Housing material: Nylon
- Housing color: black
- Protection class IP67
- RoHS conform
- cULus approval submitted
- Qualified for drag chain use
- I/O port (number of pins): 4-pin + PE

I/O port M12 x 1

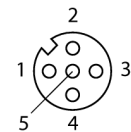

circuit diagram

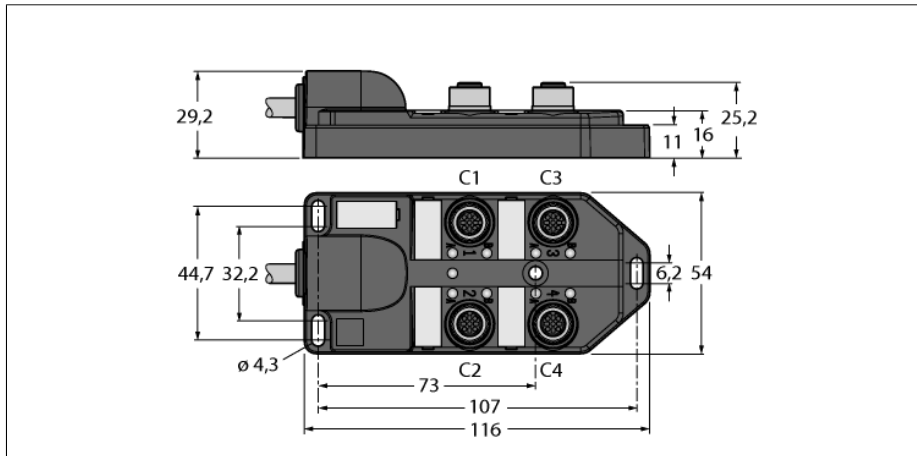
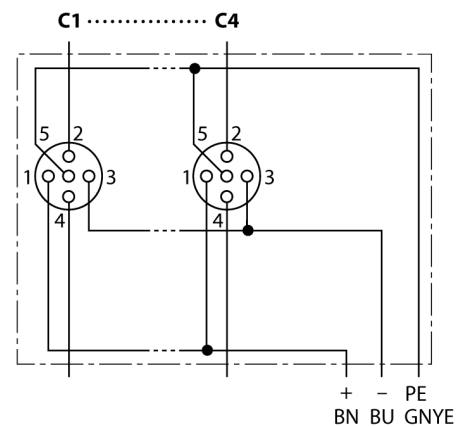

Type code	TB-4M12-5-5/TXL
Ident no.	6611908
I/O junction box	4-port, with integral homerun cable
Housing	plastic, PA 6 GF, black
I/O port	female connector, M12 x 1
Number of pins	4+PE
Thread insert	metal, CuZn, nickel-plated
Contact carriers	plastic, PA, black
Contacts	metal, CuZn, gold-plated
Seal	plastic, FPM (Viton)
Mechanical lifespan	> 100 mating cycles
Cable length	5m
Cable sheath	PUR, BK
Core insulation	PVC
Core colors	GY, RD/BU, GN, GY/PK, WH/GN, BN/GN, WH, YE BN, BU, GNYE
Core cross-section	8x0.32mm ² 3x0.82mm ²
Bending radius (mobile)	min. 15 x Ø cable
Rated voltage [U_{max}]	10 30V
Ampacity	2 A per signal contact, total current 9 A
Forward resistance	≤ 5 mΩ
Insulation resistance	≥ 10 ⁸ Ω
Ambient temperature junction	-40 ... +85°C
Degree of protection	IP67
Pollution degree	only in screwed-on condition 3

**Passive actuator/sensor junction box, M12 x 1
4-port, with integral homerun cable
TB-4M12-5-5/TXL**

Wiring

Port/Pin	C1/2	C1/4	C2/2	C2/4	C3/2	C3/4	C4/2	C4/4
M23 flange	7	15	4	5	8	16	14	3
Cable	GYPK	WH	RDBU	GN	WHGN	YE	BNGN	GY

Power C1-C8	24 V	0 V	PE
M23 flange	19	6	12
Cable	BN	BU	GNYE

Scope of delivery

Device	Quantity	Description
Junction box	1	Passive actuator/sensor junction box
VZ 3	2	Closure caps for female M12
KS9/20	5	Labels

Accessories

Ident no.	Designation	Description
6900196	CK19-0	Field-wireable female M23, 19-pin, straight
6930225	CS19-0	Field-wireable male M23, 19-pin, straight
6625616	RKC5T-2-RSC5T/TXL	Actuator/sensor cable, female M12 - male M12, straight, 5-pin, 2 m *
8000004	VZ 3	Closure caps for female M12
8015002	KS9/20	Labels

* Other lengths available on request