

Power cable for CAN (DeviceNet™, CANopen)
PUR cable jacket, 4-pole
WKM43-6-RSM43

- Power cable: 4 x 1.5 mm²)
- PUR jacket, grey
- Jacket diameter: 7.5 mm
- Qualified for drag chain use
- Oil-resistant and flame-retardant
- Halogen-free
- 7/8" male, straight
- 7/8" female, angled
- Cable length: 6.0 m

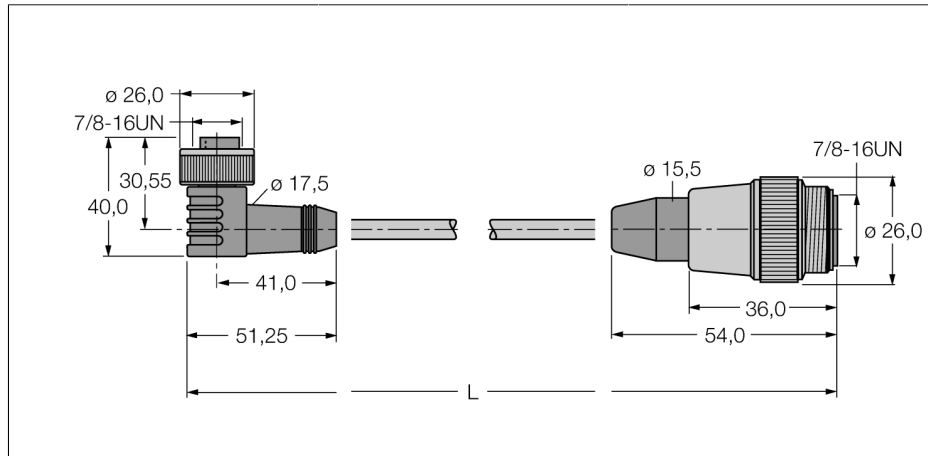

Conductor cross-section

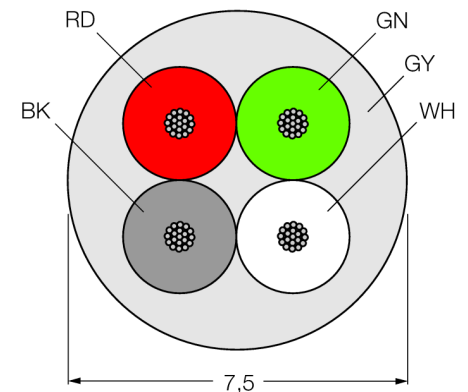

pin configuration left

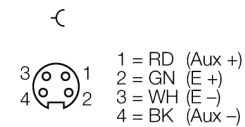

Pin assignment right

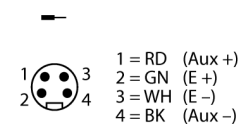

Type code	WKM43-6-RSM43
Ident no.	6913915
Connector A side	female connector, 7/8", angled
Number of pins	4
Contact carriers	plastic, TPU, black
Grip	plastic, PUR, black
Coupling nut/screw	CuZn, nickel-plated
Protection class	IP67
Connector B side	male connector, 7/8", straight
Number of pins	4
Contact carriers	plastic, TPU, black
Grip	plastic, PUR, black
Coupling nut/screw	metal, CuZn, nickel-plated
Protection class	IP67
Cable	43
Cable diameter	7.5mm
Cable length	6m
Cable sheath	PUR, grey
Shield	no
Core insulation	PP
Core colors	BK, RD, GN, WH
Core cross-section	4x1.5mm ²
Litz wire arrangement	84x0.15 mm
Nom. Impedance	- Ω
Core cross-section	5x1.5mm ²
Rated current	15 A
DC resistance	13.3 Ω
Rated voltage [Umax]	240 V
Ambient temperature	
at rest	-40 ... 90°C
In moving state	0 ... 90°C
Approvals	-
Trailing capability	yes
resistance to oil	yes
halogen-free	yes