

**7/8" round connector
female connector 7/8"
WKM30-5M**

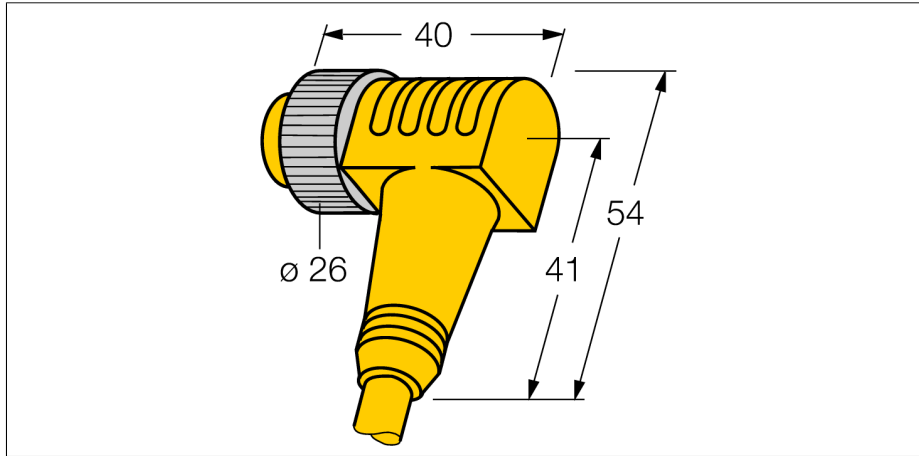

- robust and pre-assembled round connector
- plastic moulding
- Degree of protection IP67
- also available with different cable lengths and of different materials

Wiring diagram

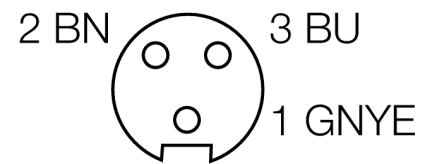

Type code	WKM30-5M
Ident no.	6915214
Connector A side	female connector, 7/8", angled
Number of pins	2+PE
Contacts	metal, CuZn, gold-plated
Contact carriers	plastic, PUR, yellow
Grip	sealing via contact carriers plastic, TPU, yellow
Protection class	stainless steel coupling nut/screw available on request IP67, (screwed together)
	sealing via contact carriers stainless steel coupling nut/screw available on request
Cable diameter	7.3 mm
Cable length	5m
Cable sheath	PVC, yellow
Core insulation	PVC
Core colors	GNYE, BN, BU
Core cross-section	2x0.83mm ²
Core cross-section PE	1x0.83mm ²
Litz wire arrangement	19x0.25 mm
Litz wire design PE	19x0.25mm
Rated voltage [Umax]	300 V
Insulation resistance	≥ 10 ⁹ Ω
Ampacity	9 A
Forward resistance	≤ 5 mΩ