

# GPTG2044

## PHASE CONTROLLED SCR

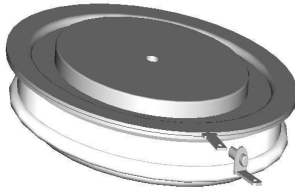

High reliability operation  
DC power supply  
AC drives

<b>VOLTAGE UP TO</b>	<b>1600 V</b>
<b>AVERAGE CURRENT</b>	<b>440 A</b>
<b>SURGE CURRENT</b>	<b>5,5 kA</b>

### BLOCKING CHARACTERISTICS

Characteristic	Conditions	Value
V <sub>RRM</sub>	Repetitive peak reverse voltage	1600 V
V <sub>RSM</sub>	Non-repetitive peak reverse voltage	1700 V
V <sub>DRM</sub>	Repetitive peak off-state voltage	1600 V
I <sub>DRM</sub>	Repetitive peak off-state current, max.	V <sub>DRM</sub> , single phase, half wave, T <sub>j</sub> = T <sub>jmax</sub>
I <sub>RRM</sub>	Repetitive peak reverse current, max.	V <sub>RRM</sub> , single phase, half wave, T <sub>j</sub> = T <sub>jmax</sub>

### ON-STATE CHARACTERISTICS

I <sub>T(AV)</sub>	Average on-state current	Sine wave, 180° conduction, T <sub>h</sub> = 55 °C	440 A
I <sub>T(RMS)</sub>	R.M.S. on-state current	Sine wave, 180° conduction, T <sub>h</sub> = 55 °C	691 A
I <sub>TSM</sub>	Surge on-state current	Non rep. half sine wave, 50 Hz, V <sub>R</sub> = 0 V, T <sub>j</sub> = T <sub>jmax</sub>	5,5 kA
I <sup>2</sup> t	I <sup>2</sup> t for fusing coordination		151 kA <sup>2</sup> s
V <sub>T(TO)</sub>	Threshold voltage	T <sub>j</sub> = T <sub>jmax</sub>	1,0 V
r <sub>T</sub>	On-state slope resistance	T <sub>j</sub> = T <sub>jmax</sub>	0,8 mΩ
V <sub>TM</sub>	Peak on-state voltage, max	On-state current I <sub>T</sub> = 1000 A, T <sub>j</sub> = T <sub>jmax</sub>	1,75 V
I <sub>H</sub>	Holding current, max	T <sub>j</sub> = 25 °C	600 mA
I <sub>L</sub>	Latching current, typ	T <sub>j</sub> = 25 °C	1000 mA

### TRIGGERING CHARACTERISTICS

V <sub>GT</sub>	Gate trigger voltage	T <sub>j</sub> = 25 °C, V <sub>D</sub> = 5 V	3,5 V
I <sub>GT</sub>	Gate trigger current	T <sub>j</sub> = 25 °C, V <sub>D</sub> = 5 V	150 mA
V <sub>GD</sub>	Non-trigger voltage	V <sub>D</sub> = 67% V <sub>RRM</sub> , T <sub>j</sub> = T <sub>jmax</sub>	0,25 V
P <sub>GM</sub>	Peak gate power dissipation	Pulse width 0.5 ms	10 W
P <sub>G(AV)</sub>	Average gate power dissipation		2 W
I <sub>FGM</sub>	Peak gate current		3 A
V <sub>FGM</sub>	Peak gate voltage (forward)		20 V
V <sub>RGM</sub>	Peak gate voltage (reverse)		5 V

### SWITCHING CHARACTERISTICS

di/dt	Critical rate of rise of on-state current	Repetitive - T <sub>j</sub> = T <sub>jmax</sub>	200 A/μs
dV/dt	Critical rate of rise of off-state voltage	T <sub>j</sub> = T <sub>jmax</sub>	500 V/μs
t <sub>q</sub>	Turn-off time, typ	T <sub>j</sub> = T <sub>jmax</sub> , I <sub>T</sub> = 320 A, di/dt = -12.5 A/μs V <sub>R</sub> = 100 V, V <sub>D</sub> = 67% V <sub>DRM</sub> , dV/dt = 20 V/μs	μs

### THERMAL AND MECHANICAL CHARACTERISTICS

R <sub>th(j-c)</sub>	Thermal resistance (junction to case)	Double side cooled	0,063 °C/W
R <sub>th(c-h)</sub>	Thermal resistance (case to heatsink)	Double side cooled	0,020 °C/W
T <sub>jmax</sub>	Max operating junction temperature		125 °C
T <sub>stg</sub>	Storage temperature		-40 / 125 °C
F	Clamping force		4,5 kN
	Mass		70 g

Current rating - sine wave

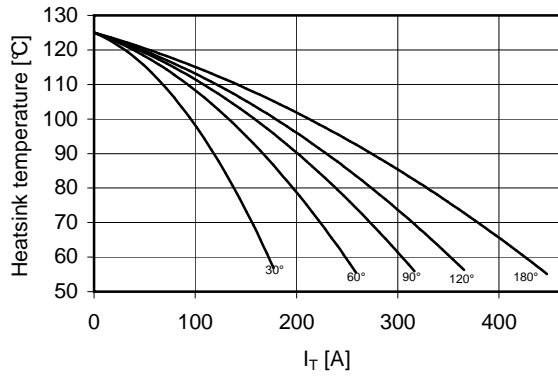

Power loss - sine wave

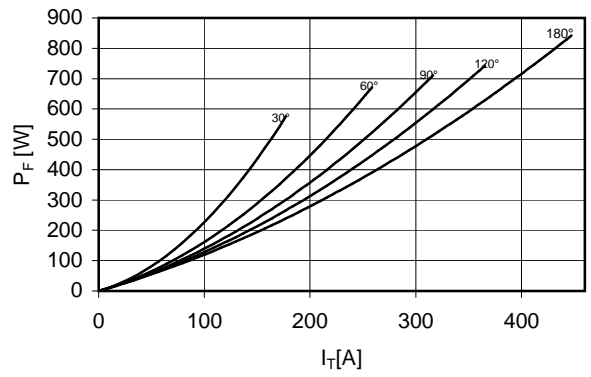

Maximum surge current  
d.s. cooled

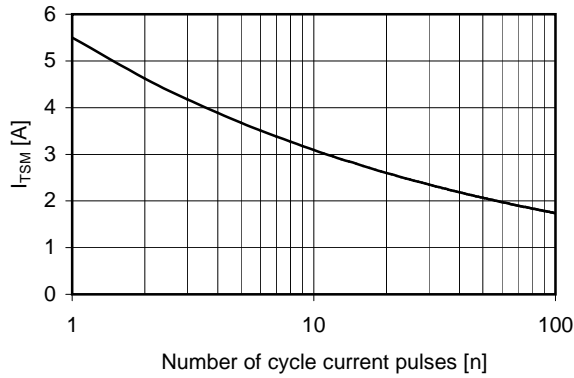

On-state voltage drop

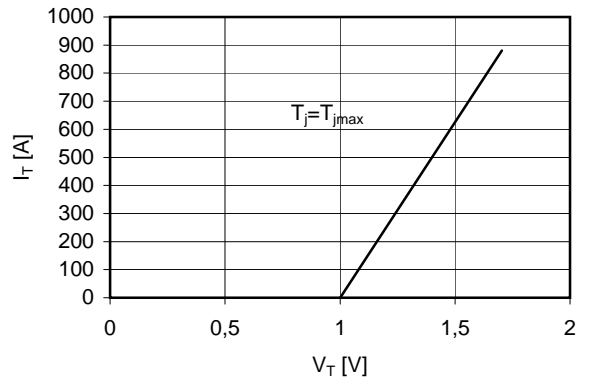

Thermal impedance (j-c)

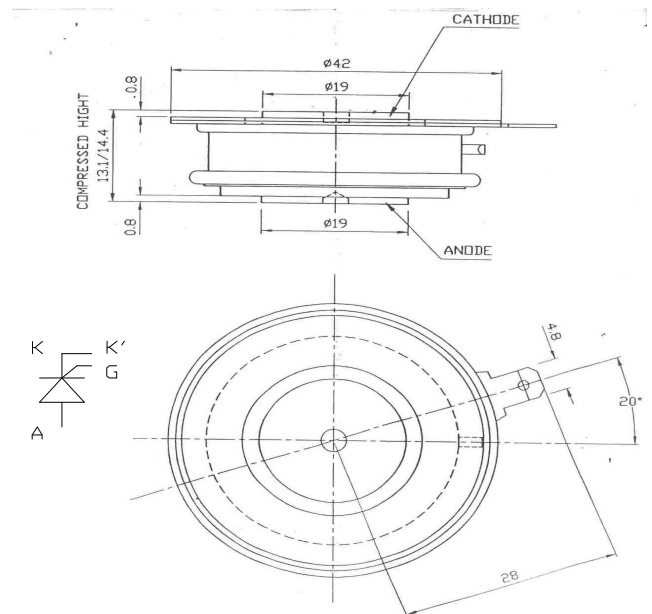
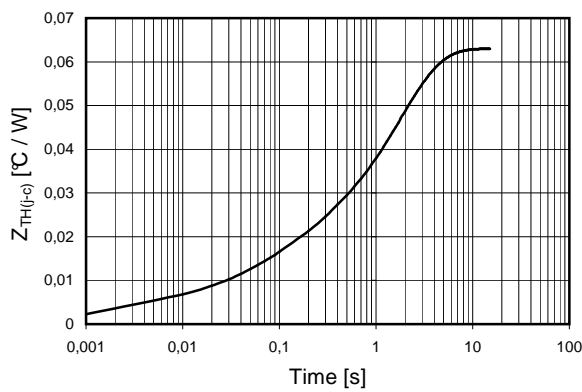

In the interest of product improvement Green Power Solutions reserves the right to change any specification given in this data sheet without notice.