

GPDN3127

AVALANCHE RECTIFIER DIODE

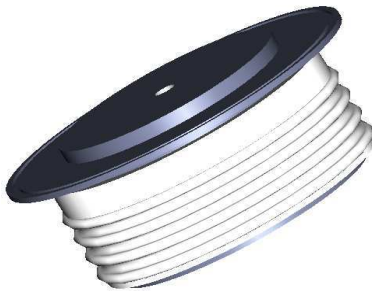

VOLTAGE UP TO 1700 - 2000 - 2300 V
AVERAGE CURRENT 1270 A
SURGE CURRENT 13,5 kA

BLOCKING CHARACTERISTICS

Characteristic	Conditions	Value
V _{RRM}	Repetitive peak reverse voltage	1700 - 2000 - 2300 V
V _{RSM}	Non-repetitive peak reverse voltage	V
I _{RRM}	Repetitive peak reverse current, max.	V _{RRM} , single phase, half wave, T _{jmax}
P _{RRM}	Peak reverse power, max	T _{jmax} , t _p = 20μs

FORWARD CHARACTERISTICS

I _{F(AV)}	Average forward current	Sine wave, 180° conduction, T _h = 55°C	1270 A
I _{F(RMS)}	R.M.S. forward current	Sine wave, 180° conduction, T _h = 55°C	1995 A
I _{FSM}	Surge forward current	Non rep. half sine wave, 50 Hz, V _R = 0 V, T _j = T _{jmax}	13,5 kA
I ² t	I ² t for fusing coordination		911 kA ² s
V _{F(TO)}	Threshold voltage	T _j = T _{jmax}	0,83 V
r _F	Forward slope resistance	T _j = T _{jmax}	0,300 mΩ
V _{FM}	Peak forward voltage, max	Forward current I _F = 2000 A, T _j = T _{jmax}	1,43 V

SWITCHING CHARACTERISTICS

Q _{rr}	Reverse recovery charge, typ	T _j = T _{jmax} , I _F = 1000 A, di/dt = -5 A/μs	μC
I _{rr}	Reverse recovery current		A

THERMAL AND MECHANICAL CHARACTERISTICS

R _{th(j-c)}	Thermal resistance (junction to case)	Double side cooled	0,040 °C/W
R _{th(c-h)}	Thermal resistance (case to heatsink)	Double side cooled	0,007 °C/W
T _{jmax}	Max operating junction temperature		160 °C
T _{stg}	Storage temperature		-40 / 160 °C
F	Clamping force ± 10%		11 kN
	Mass		300 g

Current rating - sine wave

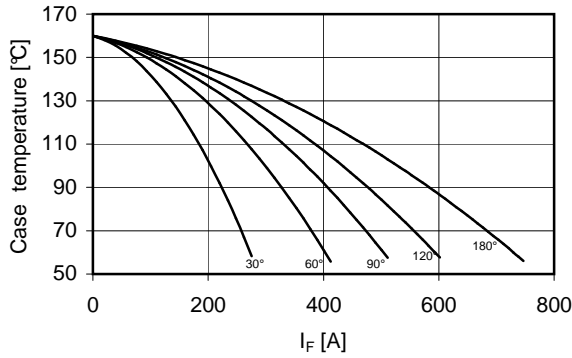

Power loss - sine wave

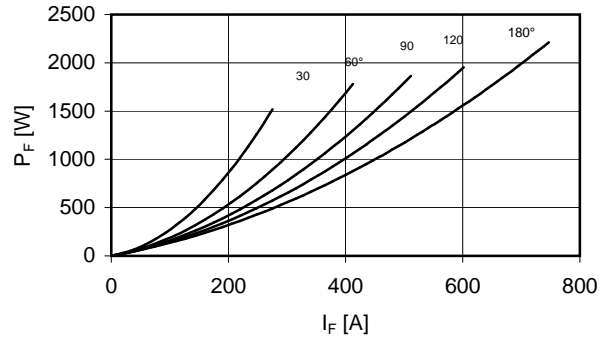

Maximum surge current
d.s. cooled

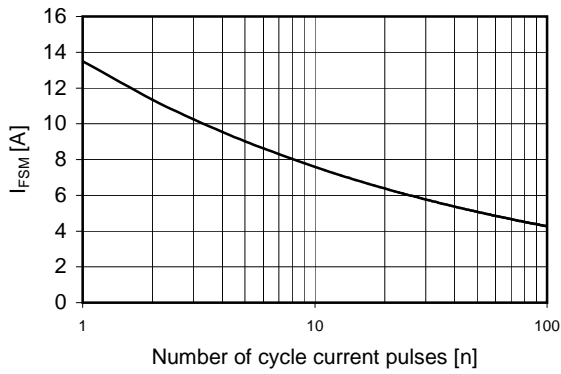

Forward voltage drop

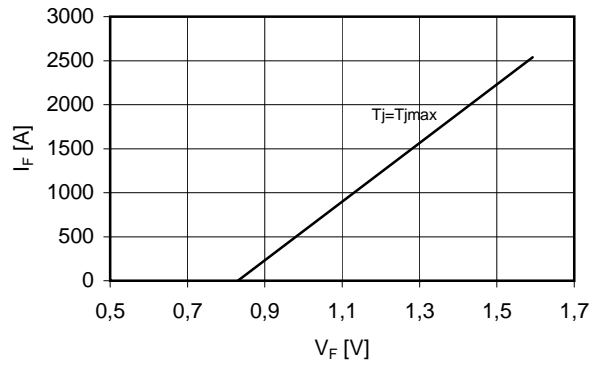

Thermal Impedance (j-c)

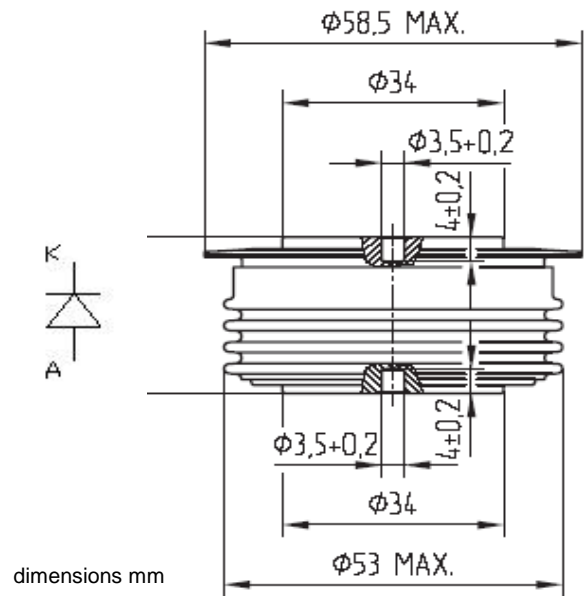
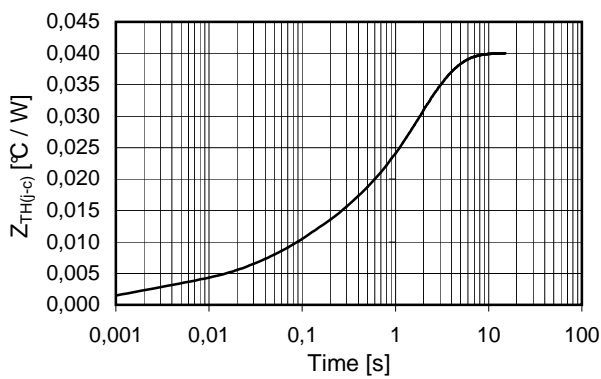

In the interest of product improvement Green Power Solutions reserves the right to change any specification given in this data sheet without notice.