

# GPDN3143

## RECTIFIER DIODE

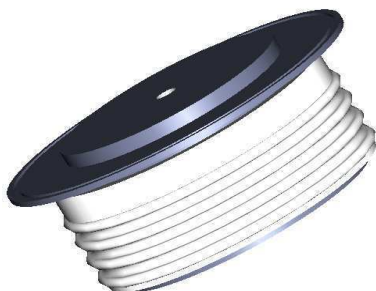

<b>BLOCKING VOLTAGE UP TO</b>	<b>2800 V</b>
<b>AVERAGE CURRENT</b>	<b>1430 A</b>
<b>SURGE CURRENT</b>	<b>15 kA</b>

### BLOCKING CHARACTERISTICS

Characteristic	Conditions	Value
V <sub>RRM</sub>	Repetitive peak reverse voltage	2800 V
V <sub>RSM</sub>	Non-repetitive peak reverse voltage	2900 V
I <sub>RRM</sub>	Repetitive peak reverse current, max.	V <sub>RRM</sub> , single phase, half wave, T <sub>jmax</sub>
		50 mA

### FORWARD CHARACTERISTICS

I <sub>F(AV)</sub>	Average forward current	Sine wave, 180° conduction, T <sub>h</sub> = 55°C	1430 A
I <sub>F(RMS)</sub>	R.M.S. forward current	Sine wave, 180° conduction, T <sub>h</sub> = 55°C	2246 A
I <sub>FSM</sub>	Surge forward current	Non rep. half sine wave, 50 Hz, V <sub>R</sub> = 0 V, T <sub>j</sub> = T <sub>jmax</sub>	15 kA
I <sup>2</sup> t	I <sup>2</sup> t for fusing coordination		1125 kA <sup>2</sup> s
V <sub>F(TO)</sub>	Threshold voltage	T <sub>j</sub> = T <sub>jmax</sub>	0,933 V
r <sub>F</sub>	Forward slope resistance	T <sub>j</sub> = T <sub>jmax</sub>	0,242 mΩ
V <sub>FM</sub>	Peak forward voltage, max	Forward current I <sub>F</sub> = 1200 A, T <sub>j</sub> = T <sub>jmax</sub>	1,22 V

### SWITCHING CHARACTERISTICS

Q <sub>rr</sub>	Reverse recovery charge, typ	T <sub>j</sub> = T <sub>jmax</sub> , I <sub>F</sub> = A, di/dt = A/μs	μC
I <sub>rr</sub>	Reverse recovery current		A

### THERMAL AND MECHANICAL CHARACTERISTICS

R <sub>th(j-c)</sub>	Thermal resistance (junction to case)	Double side cooled	0,034 °C/W
R <sub>th(c-h)</sub>	Thermal resistance (case to heatsink)	Double side cooled	0,007 °C/W
T <sub>jmax</sub>	Max operating junction temperature		160 °C
T <sub>stg</sub>	Storage temperature		-40 / 160 °C
F	Clamping force ± 10%		11 kN
	Mass		300 g

Current rating - sine wave

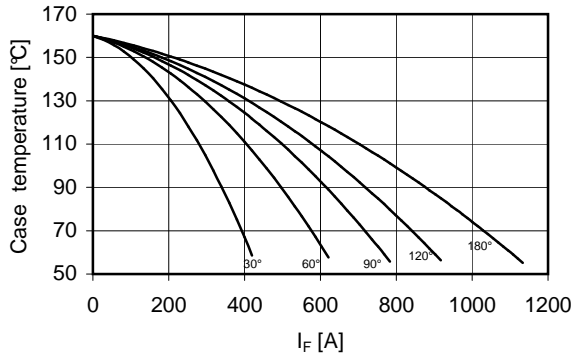

Power loss - sine wave

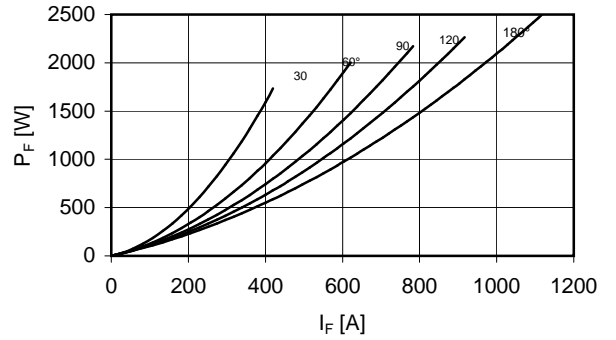

Maximum surge current d.s. cooled

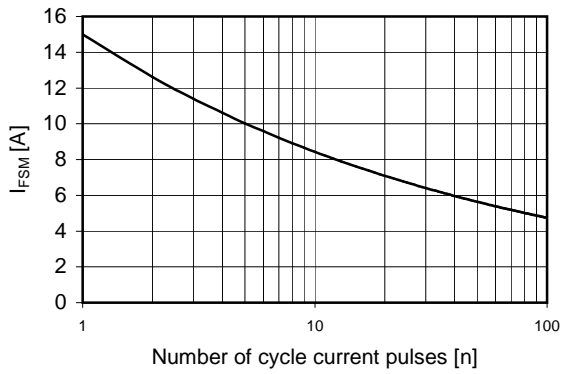

Forward voltage drop

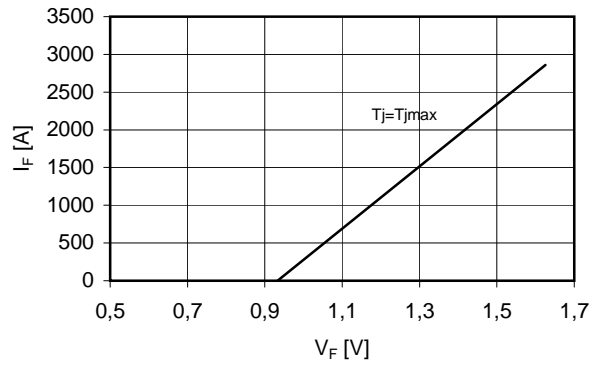

Thermal Impedance (j-c)

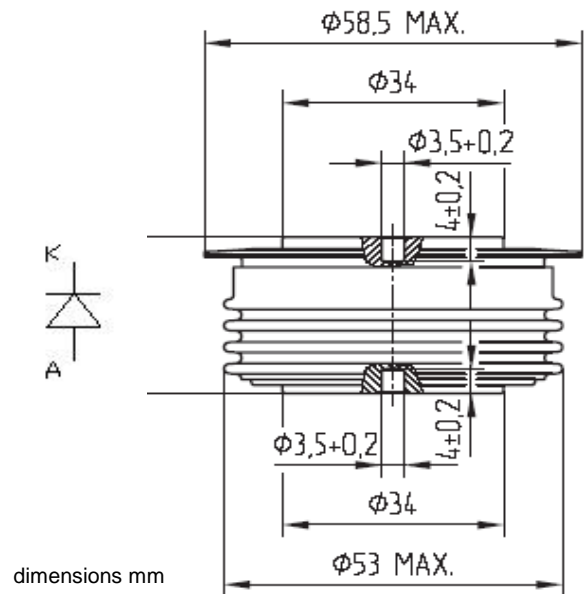
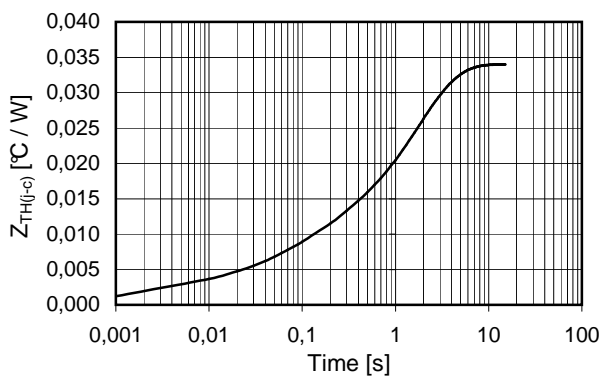

In the interest of product improvement Green Power Solutions reserves the right to change any specification given in this data sheet without notice.