

Low Charge Injection 24-Channel SPST High Voltage Analog Switch

Features

- ▶ 24 Channels of high voltage analog switch
- ▶ 3.3 or 5.0V CMOS input logic level
- ▶ 24 Channel SPST configuration
- ▶ 20MHz data shift clock frequency
- ▶ HVCMOS technology for high performance
- ▶ Very low quiescent power dissipation-10 μ A
- ▶ Low parasitic capacitance
- ▶ DC to 50MHz analog signal frequency
- ▶ -60dB typical OFF-isolation at 5.0MHz
- ▶ CMOS logic circuitry for low power
- ▶ Excellent noise immunity
- ▶ Cascadable serial data register with latches
- ▶ Flexible operating supply voltages

Applications

- ▶ Medical ultrasound imaging
- ▶ Piezoelectric transducer drivers
- ▶ Inkjet printer heads
- ▶ Optical MEMS modules

General Description

The Supertex HV2662 is a low charge injection 24-channel high voltage analog switch integrated circuit (IC) intended for use in applications requiring high voltage switching controlled by low voltage control signals, such as medical ultrasound imaging, piezoelectric transducer driver, and printers.

Input data is shifted into a 24bit shift register that can then be retained in a 24bit latch. To reduce any possible clock feed through noise, the latch enable bar should be left high until all bits are clocked in. Data are clocked in during the rising edge of the clock. Using HVCMOS technology, this device combines high voltage bilateral DMOS switches and low power CMOS logic to provide efficient control of high voltage analog signals.

The device is suitable for various combinations of high voltage supplies, e.g., V_{PP}/V_{NN} : +40V/-160V, +100V/-100V, and +160V/-40V.

Block Diagram

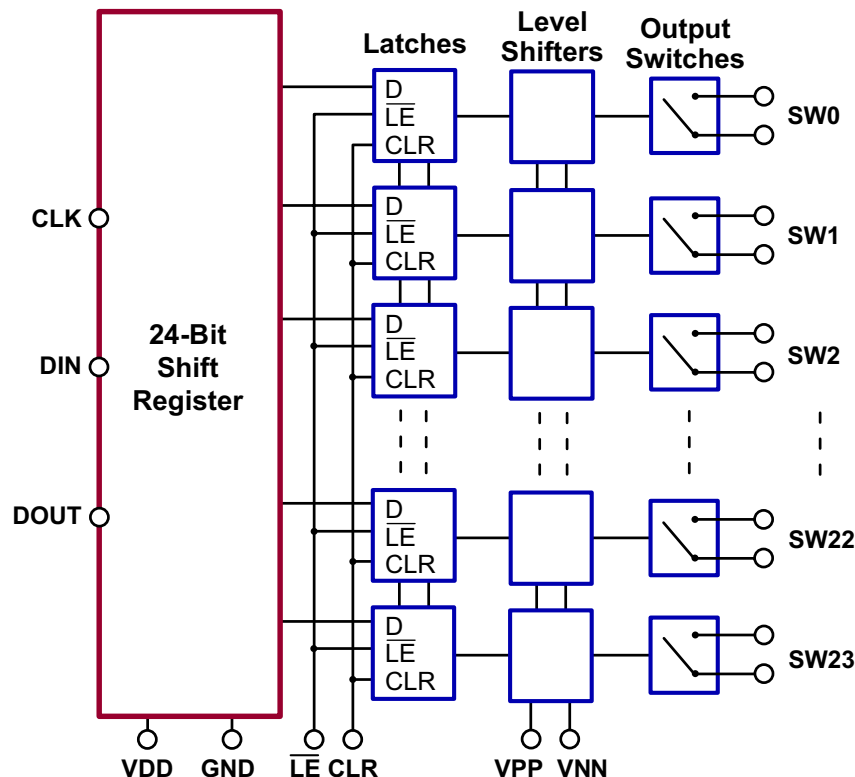

Ordering Information

Part Number	Package	Packing
HV2662LA-G	64-Pad LFGA	260/Tray
HV2662LB-G	64-Ball LFGA	260/Tray

-G indicates package is RoHS compliant ("Green")



Pin Configuration

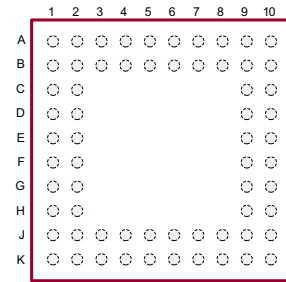

64-Lead LFGA (LA/LB)
(top view)

Absolute Maximum Ratings

Parameter	Value
V _{DD} logic supply	-0.5V to +6.5V
V _{PP} -V _{NN} differential supply	220V
V _{PP} positive supply	-0.5V to V _{NN} +200V
V _{NN} negative supply	+0.5V to -200V
Logic input voltage	-0.5V to V _{DD} +0.3V
Analog signal range	V _{NN} to V _{PP}
Peak analog signal current/channel	2.0A
Storage temperature	-65°C to 150°C
Power dissipation	1.0W

Absolute Maximum Ratings are those values beyond which damage to the device may occur. Functional operation under these conditions is not implied. Continuous operation of the device at the absolute rating level may affect device reliability. All voltages are referenced to device ground.

Product Marking

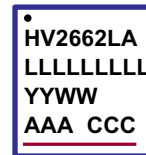

L = Lot Number
YY = Year Sealed
WW = Week Sealed
A = Assembler ID
C = Country of Origin
— = "Green" Packaging

Package may or may not include the following marks: Si or

64-Pad LFGA (LA)

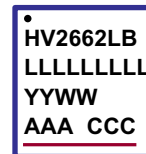

L = Lot Number
YY = Year Sealed
WW = Week Sealed
A = Assembler ID
C = Country of Origin
— = "Green" Packaging

Package may or may not include the following marks: Si or

64-Ball LFGA (LB)

Typical Thermal Resistance

Package	θ_{ja}
64-Pad LFGA	36°C/W
64-Ball LFGA	37°C/W

Recommended Operating Conditions

Sym	Parameter	Value
V _{DD}	Logic power supply voltage	3.0V to 5.5V
V _{PP}	Positive high voltage supply	+40V to V _{NN} +200V
V _{NN}	Negative high voltage supply	-40V to -160V
V _{IH}	High level input voltage	0.9V _{DD} to V _{DD}
V _{IL}	Low level input voltage	0V to 0.1V _{DD}
V _{SIG}	Analog signal voltage peak-to-peak	V _{NN} +10V to V _{PP} -10V
T _A	Operating free air temperature	0°C to 70°C

Notes:

- Power up/down sequence is arbitrary except GND must be powered-up first and powered-down last.
- V_{SIG} must be V_{NN} ≤ V_{SIG} ≤ V_{PP} or floating during power up/down transition.
- Rise and fall times of power supplies V_{DD}, V_{PP} and V_{NN} should not be less than 1.0msec.

DC Electrical Characteristics (Over recommended operating conditions unless otherwise specified)

Sym	Parameter	0°C		+25°C			+70°C		Unit	Conditions	
		Min	Max	Min	Typ	Max	Min	Max			
R _{ONS}	Small signal switch ON-resistance	-	-	-	26	-	-	-	Ω	I _{SIG} = 5.0mA	V _{PP} = +40V, V _{NN} = -160V
		-	-	-	22	-	-	-		I _{SIG} = 200mA	V _{NN} = -160V
		-	-	-	22	-	-	-		I _{SIG} = 5.0mA	V _{PP} = +100V, V _{NN} = -100V
		-	-	-	18	-	-	-		I _{SIG} = 200mA	V _{NN} = -100V
		-	-	-	20	-	-	-		I _{SIG} = 5.0mA	V _{PP} = +160V, V _{NN} = -40V
		-	-	-	16	-	-	-		I _{SIG} = 200mA	V _{NN} = -40V
ΔR _{ONS}	Small signal switch ON-resistance matching	-	20	-	5.0	20	-	20	%	I _{SIG} = 5.0mA, V _{PP} = +100V, V _{NN} = -100V	
R _{ONL}	Large signal switch ON-resistance	-	-	-	30	-	-	-	Ω	V _{SIG} = V _{PP} -10V, I _{SIG} = 1A	
I _{SOL}	Switch OFF-leakage per switch	-	5.0	-	1.0	10	-	15	μA	V _{SIG} = V _{PP} -10V, V _{NN} +10V	
V _{OS}	DC offset switch OFF	-	300	-	100	300	-	300	mV	No load	
	DC offset switch ON	-	500	-	100	500	-	500			
I _{PPQ}	Quiescent V _{PP} supply current	-	-	-	10	50	-	-	μA	All switches OFF	
I _{NNQ}	Quiescent V _{NN} supply current	-	-	-	-10	-50	-	-			
I _{PPQ}	Quiescent V _{PP} supply current	-	-	-	10	50	-	-	μA	All switches ON, I _{SW} = 5.0mA	
I _{NNQ}	Quiescent V _{NN} supply current	-	-	-	-10	-50	-	-			
I _{SW}	Switch output peak current	-	-	-	2.0	1.3	-	-	A	V _{SIG} duty cycle < 0.1%	
f _{SW}	Output switching frequency	-	-	-	-	50	-	-	kHz	Duty cycle = 50%	
I _{PP}	Average V _{PP} supply current	-	4.0	-	-	4.5	-	5.0	mA	V _{PP} = +40V, V _{NN} = -160V	All output switches are turning ON and OFF at 50kHz with no load
		-	4.0	-	-	4.5	-	5.0		V _{PP} = +100V, V _{NN} = -100V	
		-	4.0	-	-	4.5	-	5.0		V _{PP} = +160V, V _{NN} = -40V	
I _{NN}	Average V _{NN} supply current	-	4.0	-	-	4.5	-	5.0	mA	V _{PP} = +40V, V _{NN} = -160V	All output switches are turning ON and OFF at 50kHz with no load
		-	4.0	-	-	4.5	-	5.0		V _{PP} = +100V, V _{NN} = -100V	
		-	4.0	-	-	4.5	-	5.0		V _{PP} = +160V, V _{NN} = -40V	
I _{DD}	Average V _{DD} supply current	-	8.0	-	-	8.0	-	8.0	mA	f _{CLK} = 5.0MHz, V _{DD} = 5.0V	
I _{DDQ}	Quiescent V _{DD} supply current	-	10	-	-	10	-	10	μA	All logic inputs are static	
I _{SOR}	Data out source current	0.45	-	0.45	0.70	-	0.40		mA	V _{OUT} = V _{DD} -0.7V	
I _{SINK}	Data out sink current	0.45	-	0.45	0.70	-	0.40		mA	V _{OUT} = 0.7V	
C _{IN}	Logic input capacitance	-	10	-	-	10	-	10	pF	---	

* See Test Circuits on page 5

AC Electrical Characteristics (Over recommended operating conditions unless otherwise specified)

Sym	Parameter	0°C		+25°C			+70°C		Unit	Conditions
		Min	Max	Min	Typ	Max	Min	Max		
t _{SD}	Set up time before \overline{LE} rises	25	-	25	-	-	25	-	ns	---
t _{WLE}	Time width of \overline{LE}	56	-	56	-	-	56	-	ns	V _{DD} = 3.0V
		12	-	12	-	-	12	-		V _{DD} = 5.0V
t _{DO}	Clock delay time to data out	9.0	40	9.0	-	40	9.0	40	ns	V _{DD} = 3.0V
		8.0	30	8.0	-	30	8.0	30		V _{DD} = 5.0V
t _{WCLR}	Time width of CLR	55	-	55	-	-	55	-	ns	---
t _{SU}	Set up time data to clock	21	-	21	-	-	21	-	ns	V _{DD} = 3.0V
		7.0	-	7.0	-	-	7.0	-		V _{DD} = 5.0V
t _H	Hold time data from clock	5.0	-	5.0	-	-	5.0	-	ns	V _{DD} = 3.0V
		5.0	-	5.0	-	-	5.0	-		V _{DD} = 5.0V
f _{CLK}	Clock frequency	-	8	-	-	8	-	8	MHz	V _{DD} = 3.0V
		-	20	-	-	20	-	20		V _{DD} = 5.0V
t _R , t _F	Clock rise and fall times	-	50	-	-	50	-	50	ns	---
t _{ON}	Turn ON time	-	5.0	-	-	5.0	-	5.0	μs	V _{SIG} = V _{PP} -10V, R _{LOAD} = 10kΩ
t _{OFF}	Turn OFF time	-	5.0	-	-	5.0	-	5.0		
dv/dt	Maximum V _{SIG} slew rate	-	20	-	-	20	-	20	V/ns	V _{PP} = +40V, V _{NN} = -160V
		-	20	-	-	20	-	20		V _{PP} = +100V, V _{NN} = -100V
		-	20	-	-	20	-	20		V _{PP} = +160V, V _{NN} = -40V
K _O	OFF isolation	-30	-	-30	-33	-	-30	-	dB	f = 5.0MHz, 1.0KΩ//15pF load
		-58	-	-58	-60	-	-58	-		f = 5.0MHz, 50Ω load
K _{CR}	Switch crosstalk	-60	-	-60	-70	-	-60	-	dB	f = 5.0MHz, 50Ω load
I _{ID}	Output switch isolation diode current	-	300	-	-	300	-	300	mA	300ns pulse width, 2.0% duty cycle
C _{SG(OFF)}	OFF capacitance SW to GND	-	14	-	9.0	14	-	14	pF	V _{SIG} = 0V, f = 1.0MHz
C _{SG(ON)}	ON capacitance SW to GND	-	17	-	12	17	-	17		
+V _{SPK}	Output voltage spike (per switch)	-	-	-	-	150	-	-	mV	V _{PP} = +40V, V _{NN} = -160V R _{LOAD} = 50Ω
-V _{SPK}		-	-	-	-	150	-	-		
+V _{SPK}		-	-	-	-	150	-	-		V _{PP} = +100V, V _{NN} = -100V R _{LOAD} = 50Ω
-V _{SPK}		-	-	-	-	150	-	-		
+V _{SPK}		-	-	-	-	150	-	-		V _{PP} = +160V, V _{NN} = -40V R _{LOAD} = 50Ω
-V _{SPK}		-	-	-	-	150	-	-		
QC	Charge injection (per switch)	-	-	-	820	-	-	-	pC	V _{PP} = +40V, V _{NN} = -160V
		-	-	-	600	-	-	-		V _{PP} = +100V, V _{NN} = -100V
		-	-	-	350	-	-	-		V _{PP} = +160V, V _{NN} = -40V

* See Test Circuits on page 5

Test Circuits

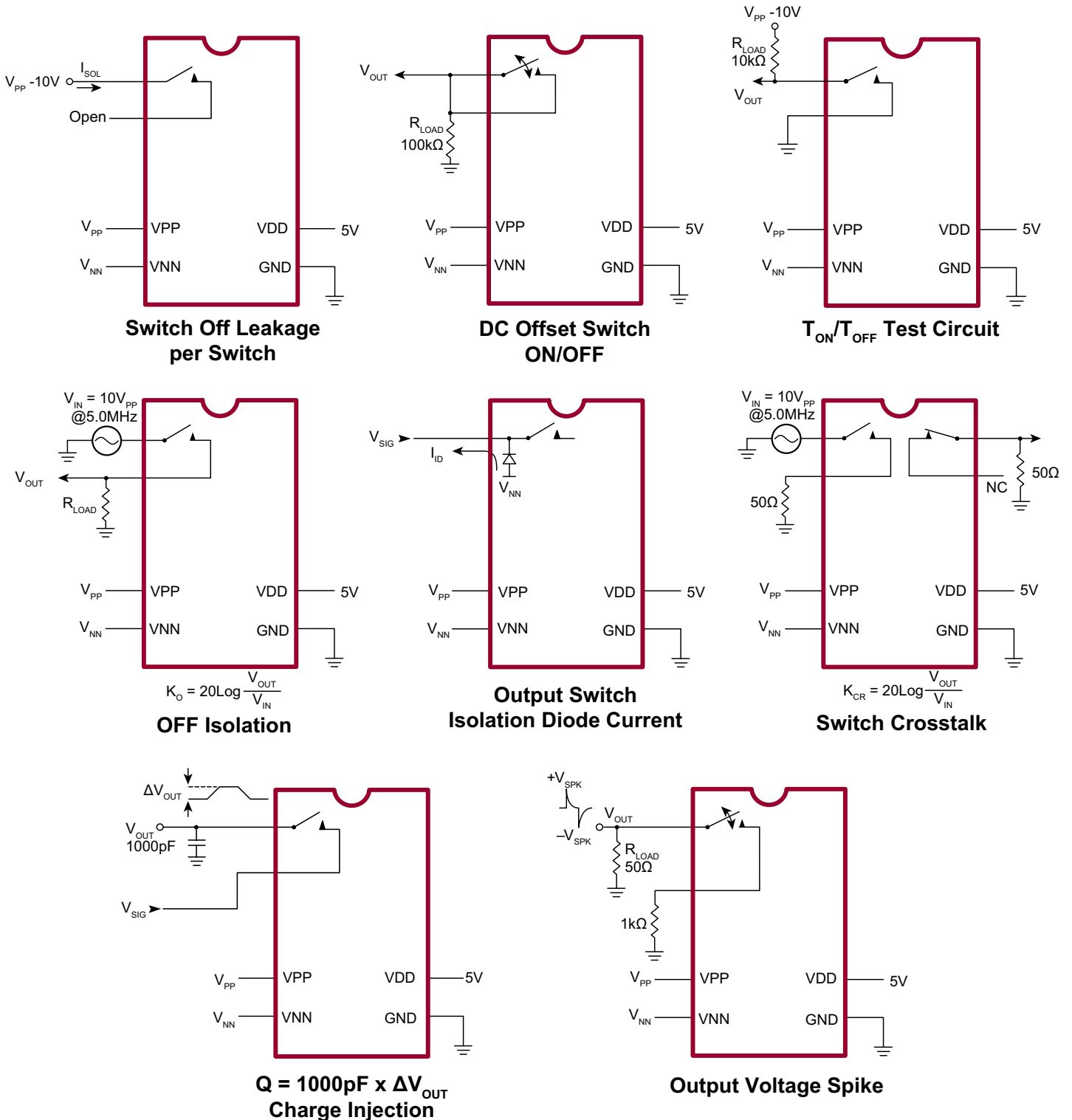

Truth Table

D0	D1	...	D15	D16	...	D23	\overline{LE}	CLR	SW0	SW1	...	SW15	SW16	...	SW23
L	-		-	-		-	L	L	OFF	-		-	-		-
H	-		-	-		-	L	L	ON	-		-	-		-
-	L		-	-		-	L	L	-	OFF		-	-		-
-	H		-	-		-	L	L	-	ON		-	-		-
-	-		-	-		-	L	L	-	-		-	-		-
-	-		-	-		-	L	L	-	-		-	-		-
-	-		L	-		-	L	L	-	-		OFF	-		-
-	-		H	-		-	L	L	-	-		ON	-		-
-	-	...	-	L	...	-	L	L	-	-		-	OFF	...	-
-	-		-	H		-	L	L	-	-		-	ON		-
-	-		-	-		-	L	L	-	-		-	-		-
-	-		-	-		-	L	L	-	-		-	-		-
-	-		-	-		-	L	L	-	-		-	-		-
-	-		-	-		-	L	L	-	-		-	-		-
-	-		-	-		-	L	L	-	-		-	-		-
-	-		-	-		L	L	L	-	-		-	-		OFF
-	-		-	-		H	L	L	-	-		-	-		ON
X	X	X	X	X	X	X	H	L	HOLD PREVIOUS STATE						
X	X	X	X	X	X	X	X	H	ALL SWITCHES OFF						

Notes:

1. The 24 switches operate independently.
2. Serial data is clocked in on the L to H transition of the CLK.
3. All 24 switches go to a state retaining their latched condition at the rising edge of \overline{LE} . When \overline{LE} is low the shift registers data flow through the latch.
4. DOUT is high when data in the register 23 is high.
5. Shift registers clocking has no effect on the switch states if \overline{LE} is high.
6. The CLR clear input overrides all other inputs.

Logic Timing Waveforms

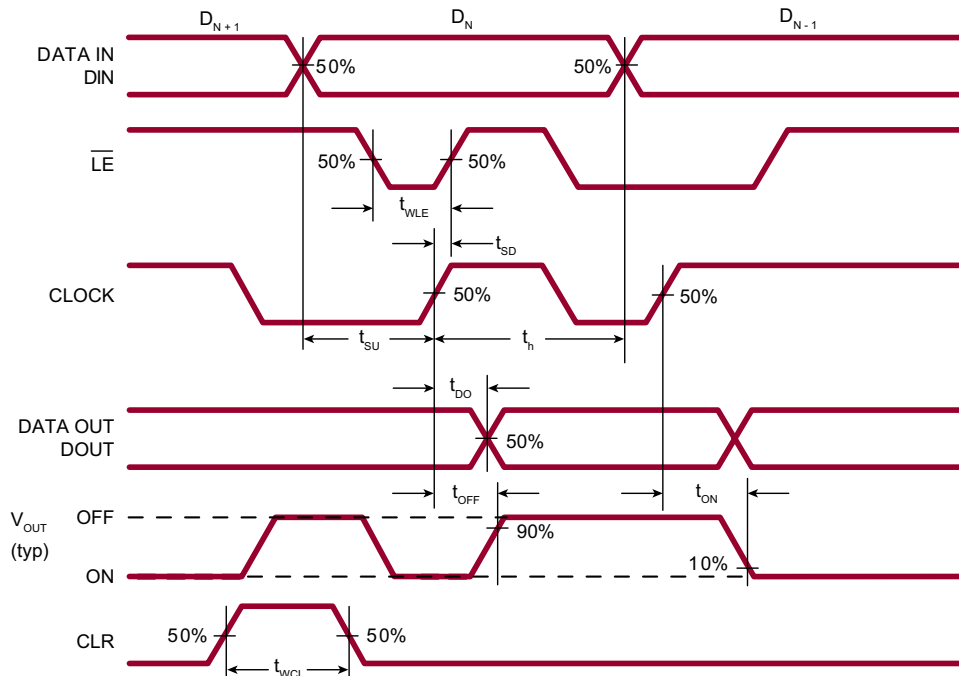

Pad Description - 64-Pad LFGA (LA)

Pin	Name	Pin	Name	Pin	Name	Pin	Name
A1	SW22B	B7	SW18A	F1	VDD	J5	SW3B
A2	VNN	B8	SW17A	F2	GND	J6	SW4B
A3	SW21B	B9	SW16A	F9	SW11B	J7	SW5B
A4	SW20B	B10	SW14B	F10	SW11A	J8	SW6B
A5	SW19B	C1	N/C	G1	DIN	J9	SW7B
A6	SW18B	C2	VPP	G2	DOUT	J10	SW9A
A7	SW17B	C9	SW14A	G9	SW10B	K1	SW1A
A8	SW16B	C10	SW13B	G10	VNN	K2	VNN
A9	SW15B	D1	CLR	H1	NC	K3	SW2A
A10	SW15A	D2	NC	H2	VPP	K4	SW3A
B1	SW23B	D9	VNN	H9	SW10A	K5	SW4A
B2	SW23A	D10	SW13A	H10	SW9B	K6	SW5A
B3	SW22A	E1	\overline{LE}	J1	SW0A	K7	SW6A
B4	SW21A	E2	CLK	J2	SW0B	K8	SW7A
B5	SW20A	E9	SW12B	J3	SW1B	K9	SW8A
B6	SW19A	E10	SW12A	J4	SW2B	K10	SW8B

Ball Description - 64-Ball LFGA (LB)

Pin	Name	Pin	Name	Pin	Name	Pin	Name
A1	SW22B	B7	SW18A	F1	VDD	J5	SW3B
A2	VNN	B8	SW17A	F2	GND	J6	SW4B
A3	SW21B	B9	SW16A	F9	SW11B	J7	SW5B
A4	SW20B	B10	SW14B	F10	SW11A	J8	SW6B
A5	SW19B	C1	N/C	G1	DIN	J9	SW7B
A6	SW18B	C2	VPP	G2	DOUT	J10	SW9A
A7	SW17B	C9	SW14A	G9	SW10B	K1	SW1A
A8	SW16B	C10	SW13B	G10	VNN	K2	VNN
A9	SW15B	D1	CLR	H1	NC	K3	SW2A
A10	SW15A	D2	NC	H2	VPP	K4	SW3A
B1	SW23B	D9	VNN	H9	SW10A	K5	SW4A
B2	SW23A	D10	SW13A	H10	SW9B	K6	SW5A
B3	SW22A	E1	\overline{LE}	J1	SW0A	K7	SW6A
B4	SW21A	E2	CLK	J2	SW0B	K8	SW7A
B5	SW20A	E9	SW12B	J3	SW1B	K9	SW8A
B6	SW19A	E10	SW12A	J4	SW2B	K10	SW8B

64-Pad LFGA Package Outline (LA)

7.00x7.00mm body, 0.85mm height (max), 0.65mm pitch

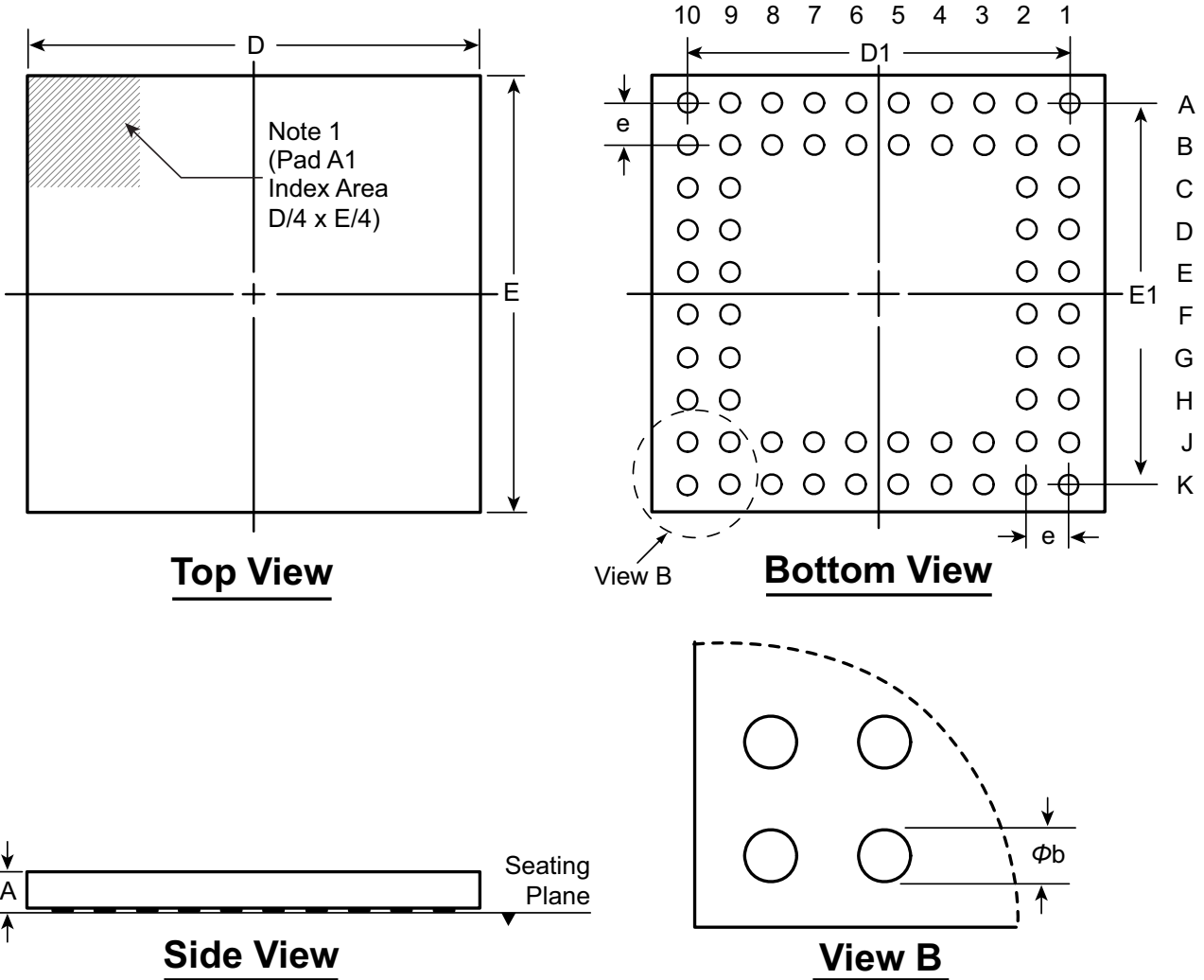

Notes:

1. Pad A1 identifier must be located in the index area indicated. Pad A1 identifier can be: a molded mark/identifier; an embedded metal marker; or a printed indicator.

Symbol		A	b	D	D1	E	E1	e
Dimension (mm)	MIN	0.75	0.25	6.925	5.85 BSC	6.925	5.85 BSC	0.65 BSC
	NOM	0.80	0.30	7.000		7.000		
	MAX	0.85	0.35	7.075		7.075		

Drawings not to scale.

Supertex Doc. #: DSPD-64LFGALA, Version A021511.

64-Ball LFGA Package Outline (LB)

7.00x7.00mm body, 1.00mm height (max), 0.65mm pitch

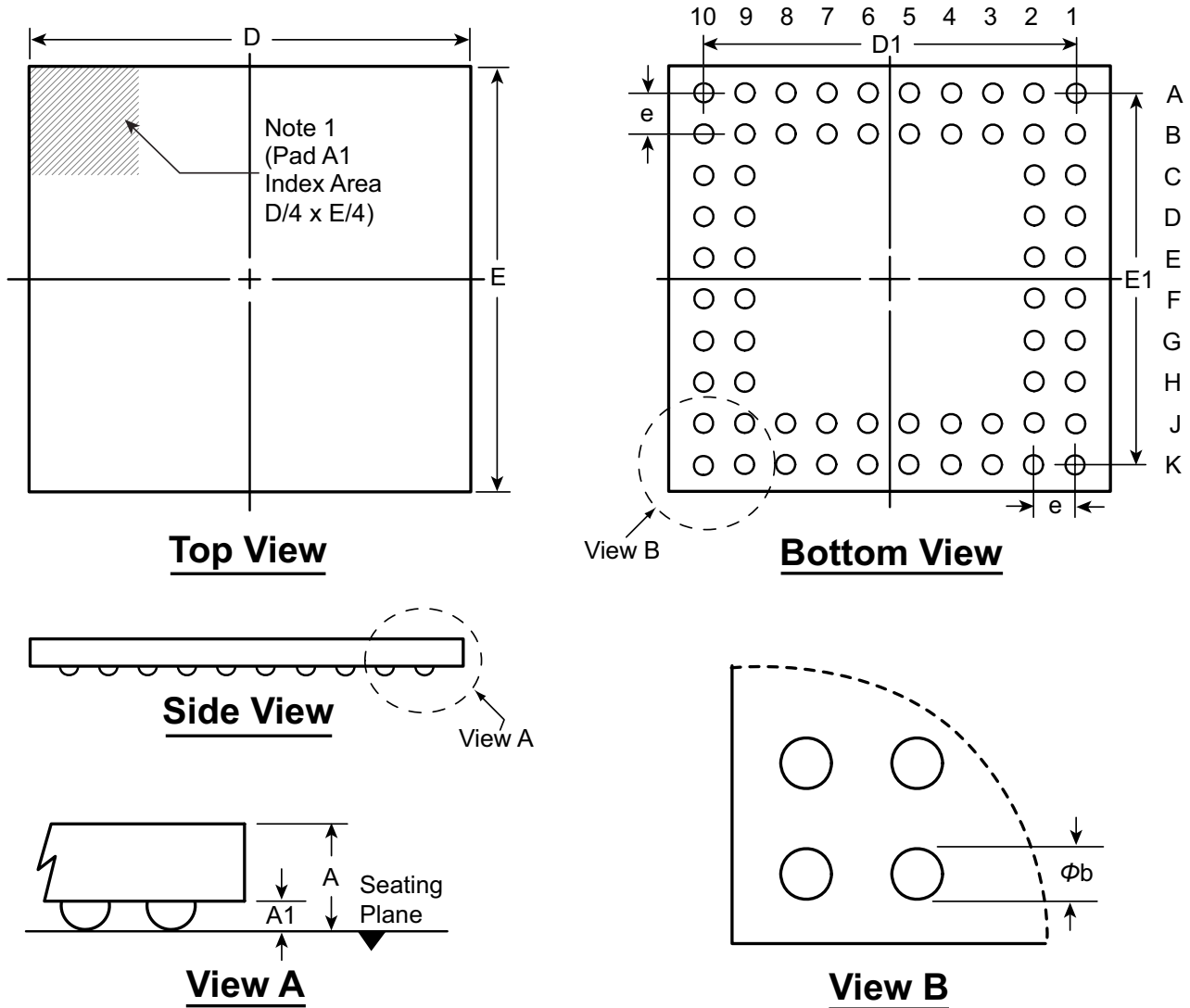

Notes:

- Ball A1 identifier must be located in the index area indicated. Ball A1 identifier can be: a molded mark/identifier; an embedded metal marker; or a printed indicator.

Symbol		A	A1	b	D	D1	E	E1	e
Dimension (mm)	MIN	0.90	0.10	0.25	6.925	5.85 BSC	6.925	5.85 BSC	0.65 BSC
	NOM	0.95	0.15	0.30	7.000		7.000		
	MAX	1.00	0.20	0.35	7.075		7.075		

Drawings not to scale.

Supertex Doc. #: DSPD-64LFGALB, Version A021511.

(The package drawing(s) in this data sheet may not reflect the most current specifications. For the latest package outline information go to <http://www.supertex.com/packaging.html>.)

Supertex inc. does not recommend the use of its products in life support applications, and will not knowingly sell them for use in such applications unless it receives an adequate "product liability indemnification insurance agreement." Supertex inc. does not assume responsibility for use of devices described, and limits its liability to the replacement of the devices determined defective due to workmanship. No responsibility is assumed for possible omissions and inaccuracies. Circuitry and specifications are subject to change without notice. For the latest product specifications refer to the Supertex inc. (website: <http://www.supertex.com>)