

## Fixed Frequency Synthesizer Surface Mount Module

### Applications

- Broadband Transmission
- Optical Transmitter
- 

### Application Notes

- AN-107: Manual Soldering Technique
- AN-205: Measuring Phase Noise for SFS Series

### Performance Specifications

	Min	Typ	Max	Units
Frequency	11300		11300	MHz
Phase Noise @ 10 kHz offset (1 Hz BW)		-82		dBc/Hz
Harmonic Suppression (2nd)		-15		dBc
Spurious Suppression		-70		dBc
Power Output	-3	0	3	dBm
Load Impedance		50		$\Omega$
Settling Time		3		mS
Operating Temperature Range	-30		75	$^{\circ}\text{C}$
Package Style		SFS-L1		

### Power Supply Requirements

	Min	Typ	Max	Units
Supply Voltage 1: PLL (Vcc, nom)		3		Vdc
Supply Voltage 2: VCO (Vcc, nom)		5		Vdc
Supply Current 1: PLL (Icc, typ)		11		mA
Supply Current 2: VCO (Icc, typ)		95		mA

### Reference Oscillator Signal

	Min	Typ	Max	Units
Frequency		10		MHz
Phase Noise @1 kHz Offset		-145		dBc/Hz

### Additional Notes

LFSuffix = RoHS Compliant. All specifications are subject to change without notice.

© Z-Communications, Inc. All Rights Reserved.

14118 Stowe Drive, Suite B | Poway, CA 92064 | TEL: (858) 621-2700 | FAX: (858) 486-1927

URL: [www.zcomm.com](http://www.zcomm.com) | EMAIL: [applications@zcomm.com](mailto:applications@zcomm.com)

**Phase Noise, typ.**

**Footprint**

PHASE NOISE (1 Hz BW, typical)

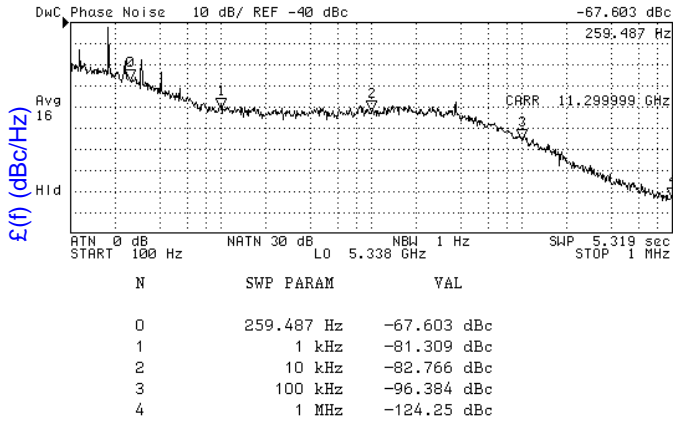

RECOMMENDED FOOTPRINT

SEVERAL HOLES OF  $\varnothing$  0.015 ON GND. PLANE ARE RECOMMENDED FOR GOOD GROUNDING.

0.030 MIN. CUTBACK FROM LIVE PADS

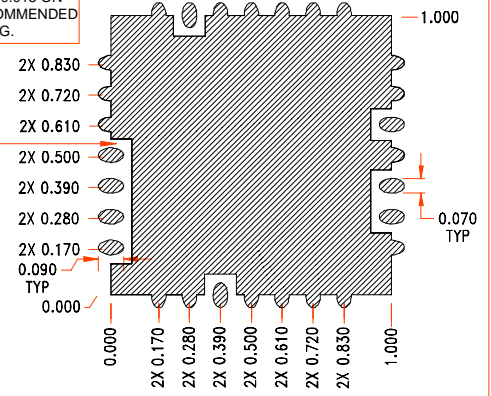

OFFSET (Hz)

**Physical Dimensions**

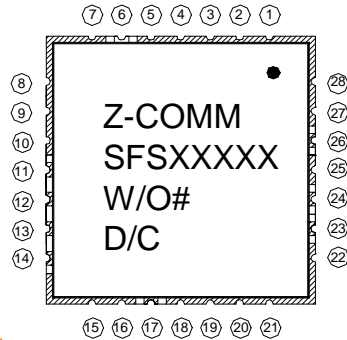
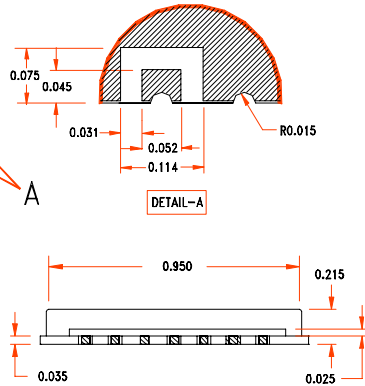
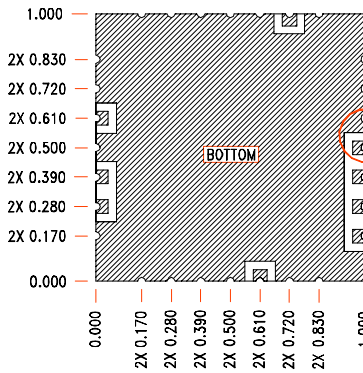

PIN CONFIGURATION	
6	RF OUT
11	LOCK DETECT
12	N/C
13	N/C
14	N/C
17	REF IN
23	N/C
24	Vcc CHIP
26	Vcc VCO
REST	GROUND

NOTE: ALL DIMENSIONS ARE IN INCHES  
TOL: XXX: +/- 0.010