

# Soft Recovery Diode Types M0451YX120 to M0451YX200

The data sheet on the subsequent pages of this document is a scanned copy of existing data for this product.  
(Rating Report 83NR10 Issue 1)

This data reflects the old part number for this product which is: SM12-20CXC176.  
This part number must **NOT** be used for ordering purposes – please use the ordering particulars detailed below.

The limitations of this data are as follows:  
Only YC outline drawing (W2) in datasheet

The following links will direct you to the appropriate outline drawings  
[Outline W2](#) – 15.1mm Clamp height  
[Outline W3](#) – 26.6mm Clamp height



Where any information on the product matrix page differs from that in the following data, the product matrix must be considered correct

An electronic data sheet for this product is presently in preparation.

For further information on this product, please contact your local ASM or distributor.

Alternatively, please contact Westcode as detailed below.

<b>Ordering Particulars</b>			
M0451	YX	◆◆	0
Fixed Type Code	YC - 14.5mm Clamp height YH – 26mm Clamp height	Voltage code $V_{RRM}/100$ 12-20	Fixed Code
Typical Order Code: M0451YH160, 26mm Clamp height, 1600V $V_{RRM}$			

<p><b>IXYS Semiconductor GmbH</b> Edisonstraße 15 D-68623 Lampertheim Tel: +49 6206 503-0 Fax: +49 6206 503-627 E-mail: <a href="mailto:marcom@ixys.de">marcom@ixys.de</a></p>	 An  IXYS Company  <a href="http://www.westcode.com">www.westcode.com</a>  <a href="http://www.ixys.com">www.ixys.com</a>	<p><b>Westcode Semiconductors Ltd</b> Langley Park Way, Langley Park, Chippenham, Wiltshire, SN15 1GE. Tel: +44 (0)1249 444524 Fax: +44 (0)1249 659448 E-mail: <a href="mailto:WSL.sales@westcode.com">WSL.sales@westcode.com</a></p>	
<p><b>IXYS Corporation</b> 3540 Bassett Street Santa Clara CA 95054 USA Tel: +1 (408) 982 0700 Fax: +1 (408) 496 0670 E-mail: <a href="mailto:sales@ixys.net">sales@ixys.net</a></p>		<p><b>Westcode Semiconductors Inc</b> 3270 Cherry Avenue Long Beach CA 90807 USA Tel: +1 (562) 595 6971 Fax: +1 (562) 595 8182 E-mail: <a href="mailto:WSI.sales@westcode.com">WSI.sales@westcode.com</a></p>	
<p>The information contained herein is confidential and is protected by Copyright. The information may not be used or disclosed except with the written permission of and in the manner permitted by the proprietors Westcode Semiconductors Ltd.</p>			<p>© Westcode Semiconductors Ltd.</p>
<p>In the interest of product improvement, Westcode reserves the right to change specifications at any time without prior notice.</p>			
<p>Devices with a suffix code (2-letter, 3-letter or letter/digit/letter combination) added to their generic code are not necessarily subject to the conditions and limits contained in this report.</p>			

QUALITY EVALUATION LABORATORY

Rating Report: 83NR10

Date: 5th December, 1983

Origin:

Pages: 28

Diode Type SM12-M20CXC176

Written: B.W.P. Brown

Checked: *BA*

Approved: *BWA*

The CXC176 is a high power, high voltage, fast recovery, all diffused diode based on a slice diameter of 24 mm and provides an extension of voltage range above that of the type CXC170. For use in inverters and transistor switching regulators.

Ratings and Characteristics

Ratings

Voltage Grades	:	12-20
$V_{RSM}$	:	1300-2100V
$V_{RRM}$	:	1200-2000V
$V_{RWM}$	:	1050-1800V
$I_{F(AV)}$ : Single phase; 50Hz, 180° half sinewave; (converter ratings)	:	
Double side cooled. $T_{HS} = 55^{\circ}C, 100^{\circ}C$	:	434A; 202A
Single side cooled. $T_{HS} = 100^{\circ}C$	:	114A
$I_{F(rms)}$ $T_{HS} = 25^{\circ}C$	:	870A
$I_F$ $T_{HS} = 25^{\circ}C$	:	724A
$I_{FSM}$ : t = 10ms half sinewave; $T_J$ (initial) = 125°C;	:	
$V_{RM} = 0.6 V_{RRM(MAX)}$	:	4500A
$I_{FSM}$ : t = 10ms half sinewave; $T_J$ (initial) = 125°C;	:	
$V_{RM} \leq 10V$	:	4950A
$I^2t$ : t = 10ms; $T_J$ (initial) = 125°C; $V_{RM} = 0.6 V_{RRM(MAX)}$	:	$101 \times 10^3 A^2 SEC$
$I^2t$ : t = 10ms; $T_J$ (initial) = 125°C; $V_{RM} \leq 10V$	:	$122 \times 10^3 A^2 SEC$
$I^2t$ : t = 3ms; $T_J$ (initial) = 125°C; $V_{RM} \leq 10V$	:	$91 \times 10^3 A^2 SEC$
$T_{HS}$ operating range	:	-40 to +125°C
$T_{stg}$ ; non-operating	:	-40 to +150°C

Characteristics

(Maximum values unless stated otherwise)

$V_D : T_J = 125^{\circ}\text{C}$	: 1.00V
$r_s : T_J = 125^{\circ}\text{C}$	: 8.74 mohms
$V_{FM} : I_{FM} = 635\text{A} \quad T_{VJ} = 125^{\circ}\text{C}$	: 1.47V
$R_{th}(J-HS)$ Double side cooled	: $0.085^{\circ}\text{C/W}$
Single side cooled	: $0.17^{\circ}\text{C/W}$
$I_{RRM} : T_J = 125^{\circ}\text{C} \quad V_{RM} = V_{RRM}(\text{MAX})$	: 20mA
$Q_{rr} : I_{FM} = 550\text{A} \quad ; \quad dI/dt = 40\text{A}/\mu\text{s}$	: 160uC max.
$V_{RM} = 50\text{V} \quad T_{VJ} = 125^{\circ}\text{C}$	:
Mounting Force :	: 330-55Kg.f
Outline Drawing :	: 101A260

CONTENTS

	<u>Page</u>
Ratings and characteristics	1,2
Voltage grade table	4
(2) <u>Introduction</u>	5
(3) <u>Notes on the ratings</u>	
a) Square-wave ratings	5
b) Energy per pulse characteristics	5
c) Junction temperature rise per pulse	6
(4) <u>Reverse Recovery Loss</u>	
a) Determination by Measurement	6
b) Determination without Measurement	7
Limit Forward Characteristic	8
Transient Thermal Impedance	8
Surge Rating	9
50 Hz Converter Ratings double side cooled	10
50 Hz Coverter Ratings single side cooled	11
Recovered Charge	12
S. Factor	13
Reverse recovery energy per pulse	14
Reverse recovery temperature rise per pulse	15
Square wave frequency rating 85°C Sink 200A/μs	16
"    "    "    "    55°C    "    "	17
"    "    "    "    85°C    "    100A/μs	18
"    "    "    "    55°C    "    "	19
Temperature rise per pulse 200A/μs	20
"    "    "    "    100A/μs	21
Energy per pulse 200A/μs	22
"    "    "    100A/μs	23
Sine wave frequency rating 85°C Sink	24
"    "    "    "    55°C    "	25
Sinewave Temperature rise per pulse	26
Sinewave energy per pulse	27
Outline drawing	28

Voltage Ratings

Voltage Class	$V_{RRM}$ V	$V_{RSM}$ V
12	1200	1300
14	1400	1500
16	1600	1700
18	1800	1900
20	2000	2100

This Report is applicable to higher or lower voltage grades when supply has been agreed by Sales/Production.

## 2.0 INTRODUCTION

The diode series comprises fast recovery cold-weld capsules with 24 mm all diffused silicon slices. All these diodes have controlled reverse recovery characteristics with good "S" factors. These devices will find applications as "free wheel" diodes in transistor switching circuits.

## 3.0 NOTES ON THE RATINGS

### a) Square wave ratings

These ratings are given for leading edge linear rates of rise of forward current of 100 and 200/ $\mu$ S.

### b) Energy per pulse characteristics

These curves enable rapid estimation of device dissipation to be obtained for conditions not covered by the frequency ratings.

Let:  $E_p$  be the Energy per pulse for a given current and pulse width, in joules

Then  $W_{AV} = E_p \times f$ .

### c) Junction temperature rise per pulse

Junction temperature rise at end of conduction over a single pulse is given but is only required for low duty cycle ( $\leq 1\%$ ) or single pulse operation.

$$T_{SINK} = 125 - T - E_p f R_{th}$$

where  $f$  = number of pulses per second, Hz

and  $T$  = temperature rise for single pulse, deg. C.

#### 4.0 REVERSE RECOVERY LOSS

On account of the number of circuit variables affecting reverse recovery voltage, no allowance for reverse recovery loss has been made in these ratings. The following procedure is recommended for use where it is necessary to include reverse recovery loss.

##### a) Determination by Measurement

From waveforms of recovery current obtained from a high frequency shunt (see Note 1) and reverse voltage present during recovery, an instantaneous reverse recovery loss waveform must be constructed. Let the area under this waveform be A joules per pulse. A new heat sink temperature can then be evaluated from:

$$T_{\text{SINK}} (\text{new}) = T_{\text{SINK}} (\text{original}) - A \left( \frac{r_t + .10^6}{t} + R_{\text{th}} \times f \right)$$

$$\text{where } r_t = 1.64 \times 10^{-4} \sqrt{t}$$

t = duration of reverse recovery loss per pulse in microseconds

A = Area under reverse loss waveform per pulse in joules (W.S.)

f = rated frequency at the original heat sink temperature

The total dissipation is now given by

$$W_{(\text{TOT})} = W_{(\text{original})} + A \times f$$

##### Note 1

##### REVERSE RECOVERY LOSS BY MEASUREMENT

This device has a low reverse recovered charge and peak reverse recovery current. When measuring the charge care must be taken to ensure that:

- a) a.c. coupled devices such as current transformers are not affected by prior passage of high amplitude forward current.
- b) The measuring oscilloscope has adequate dynamic range - typically 100 screen heights - to cope with the initial forward current without overload.
- c) Measurement of reverse recovery voltage waveform should be carried out with an appropriate snubber of 0.1uF and 5ohms in series connected across diode anode to cathode.

b) Design Method

In circumstances where it is not possible to measure voltage and current conditions, or for design purposes, the additional losses and transient junction temperature rise may be estimated from curves on pages 14 and 15.

Let  $E$  be the value of energy per reverse cycle in joules (curves on p. 14)

Let  $\theta$  be the value of temperature rise per reverse recovery cycle (degrees centigrade) (curves on p. 15)

Let  $f$  be the operating frequency in Hz

Then  $T_{\text{SINK new}} = T_{\text{SINK original}} - \theta - ER_{\text{th}} f$

Where  $T_{\text{SINK new}}$  is the required maximum heat sink temperature and  $T_{\text{SINK original}}$  is the heatsink temperature given with the frequency ratings.

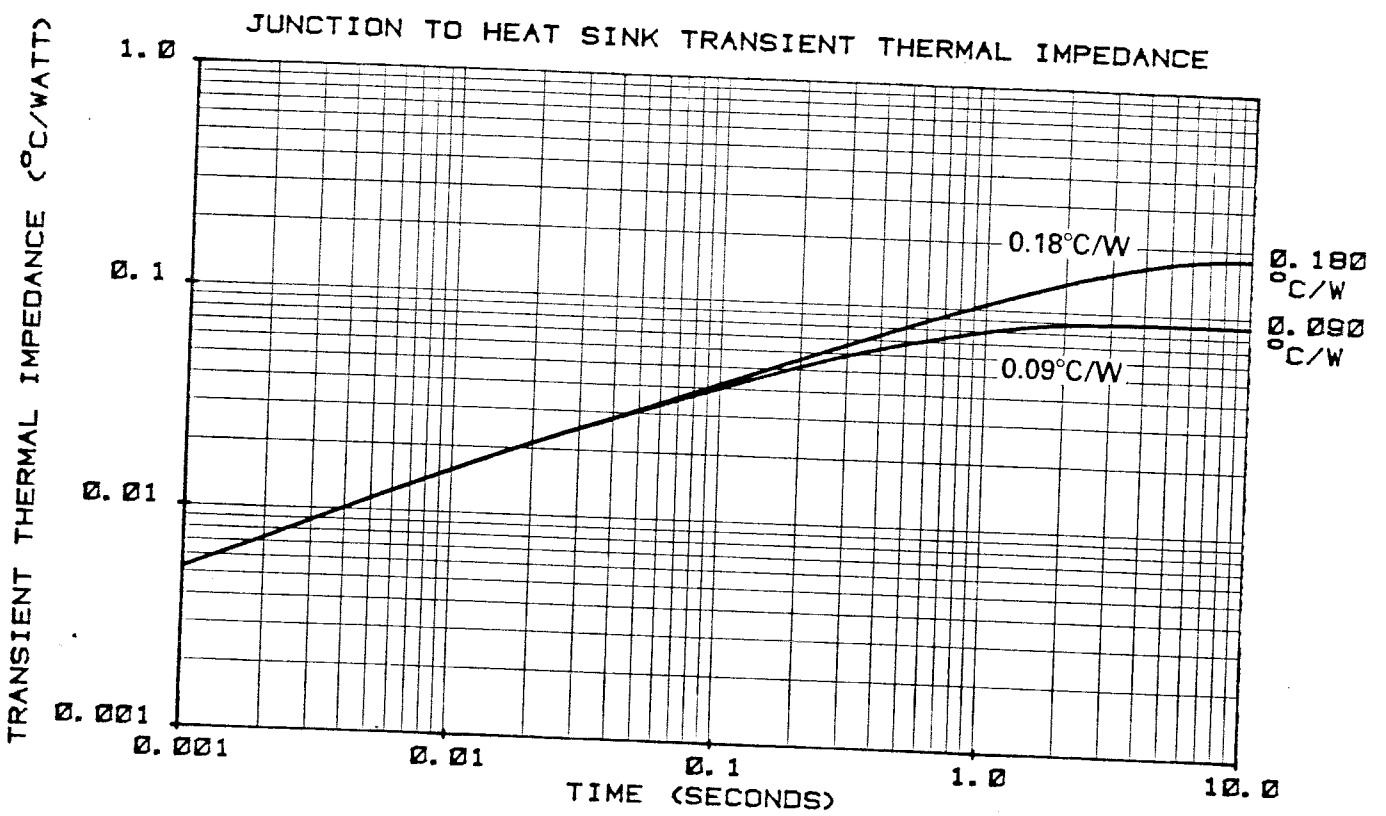
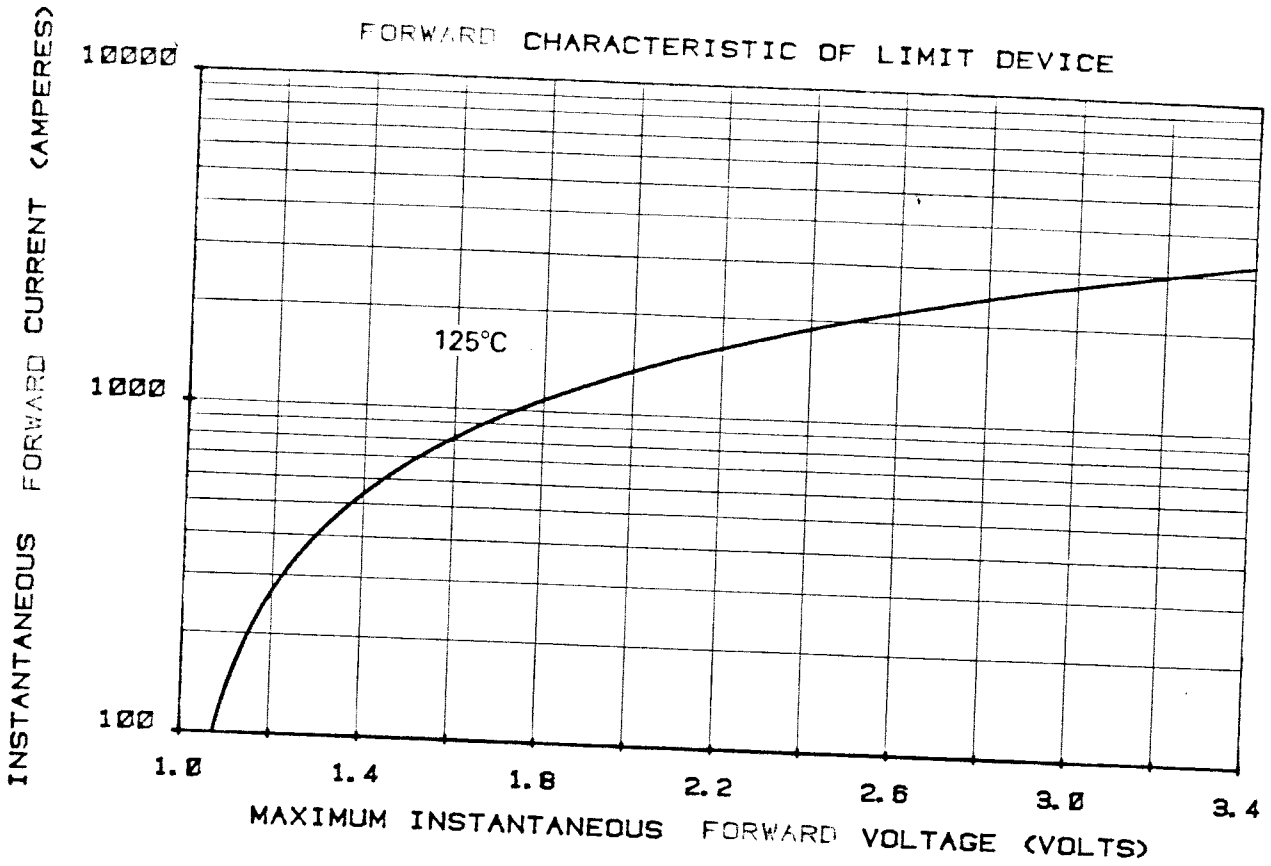

MAXIMUM NON REPETITIVE SURGE CURRENT AT INITIAL JUNCTION TEMPERATURE 125°C

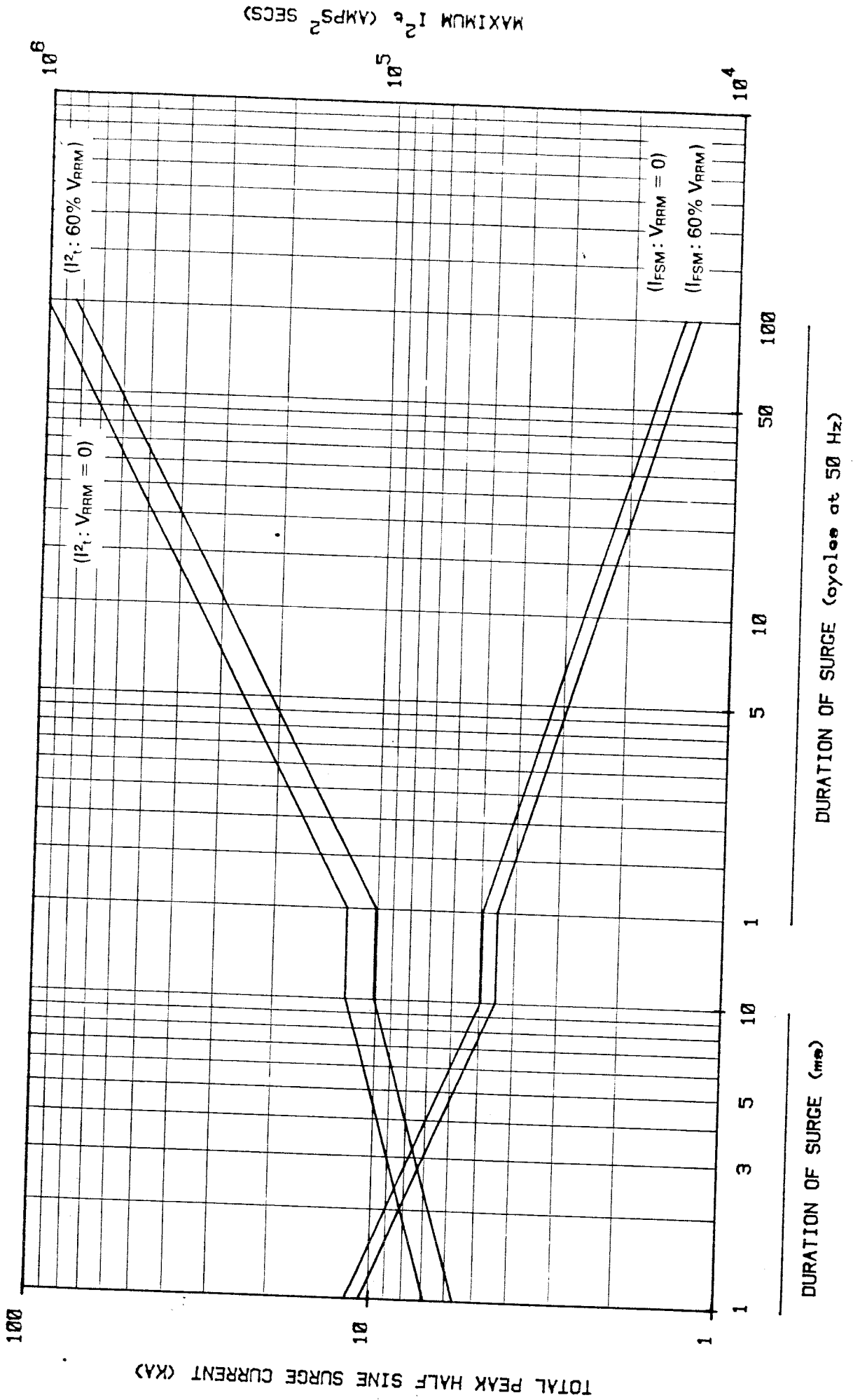

DOUBLE SIDE COOLED

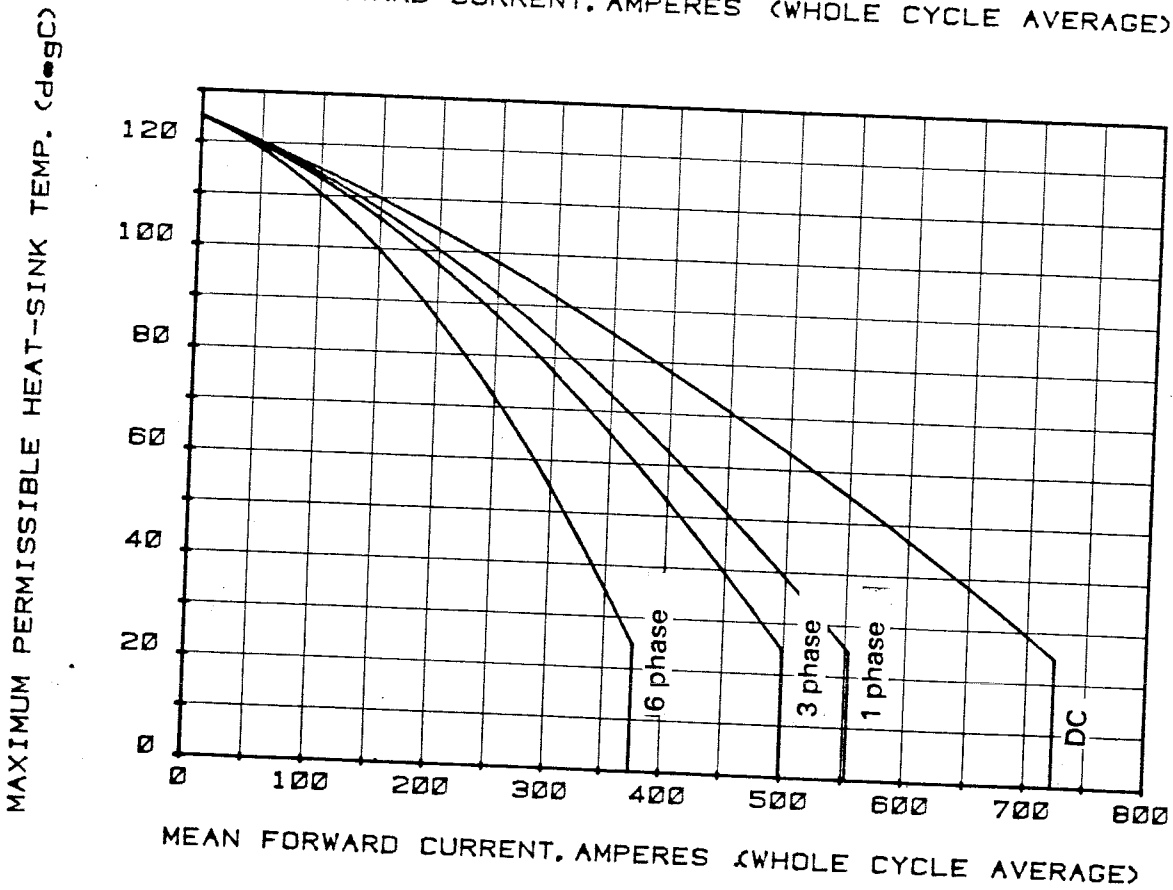
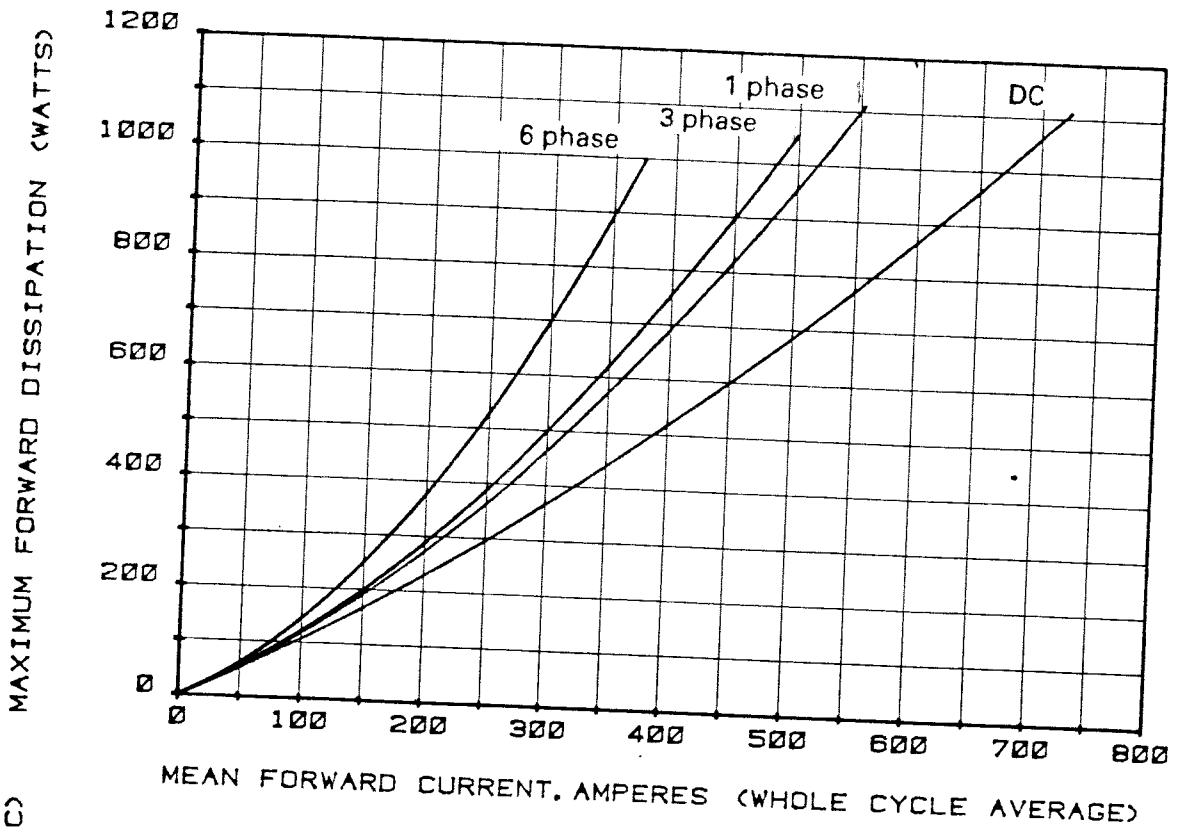

SINGLE SIDE COOLED

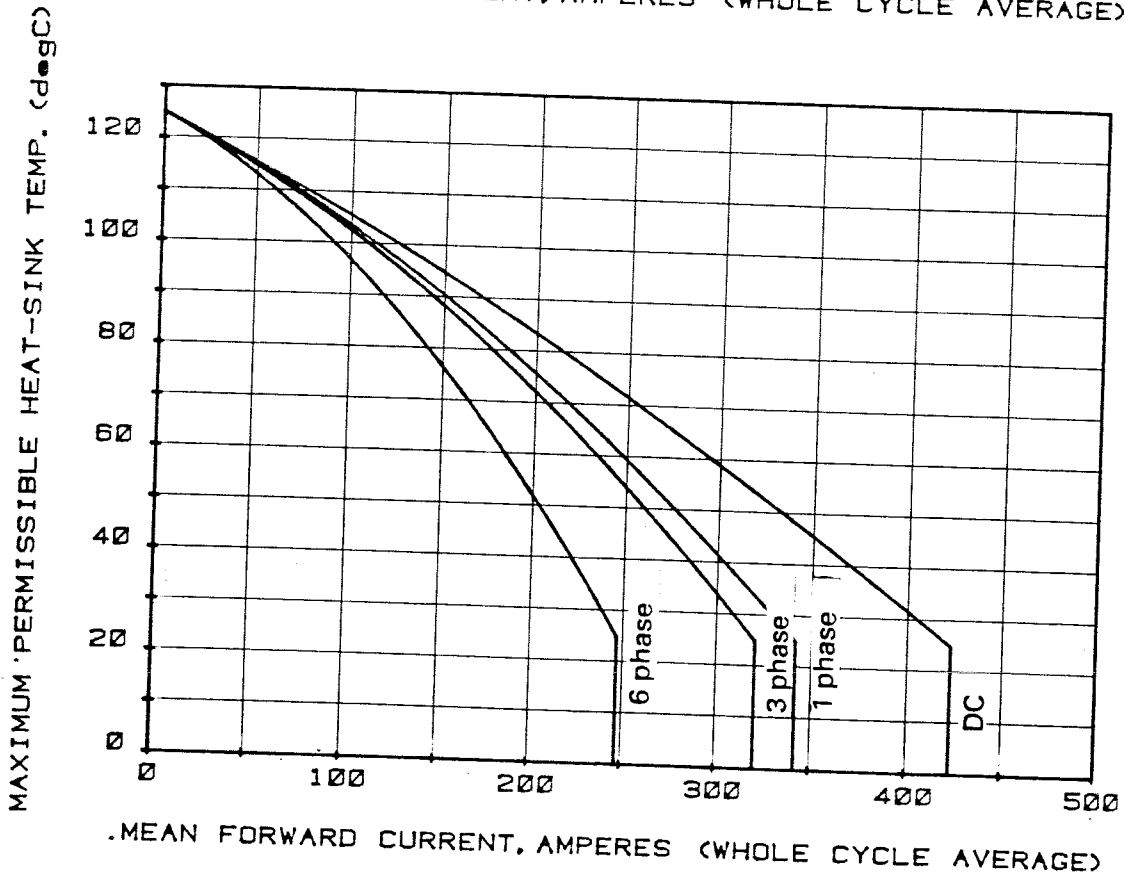
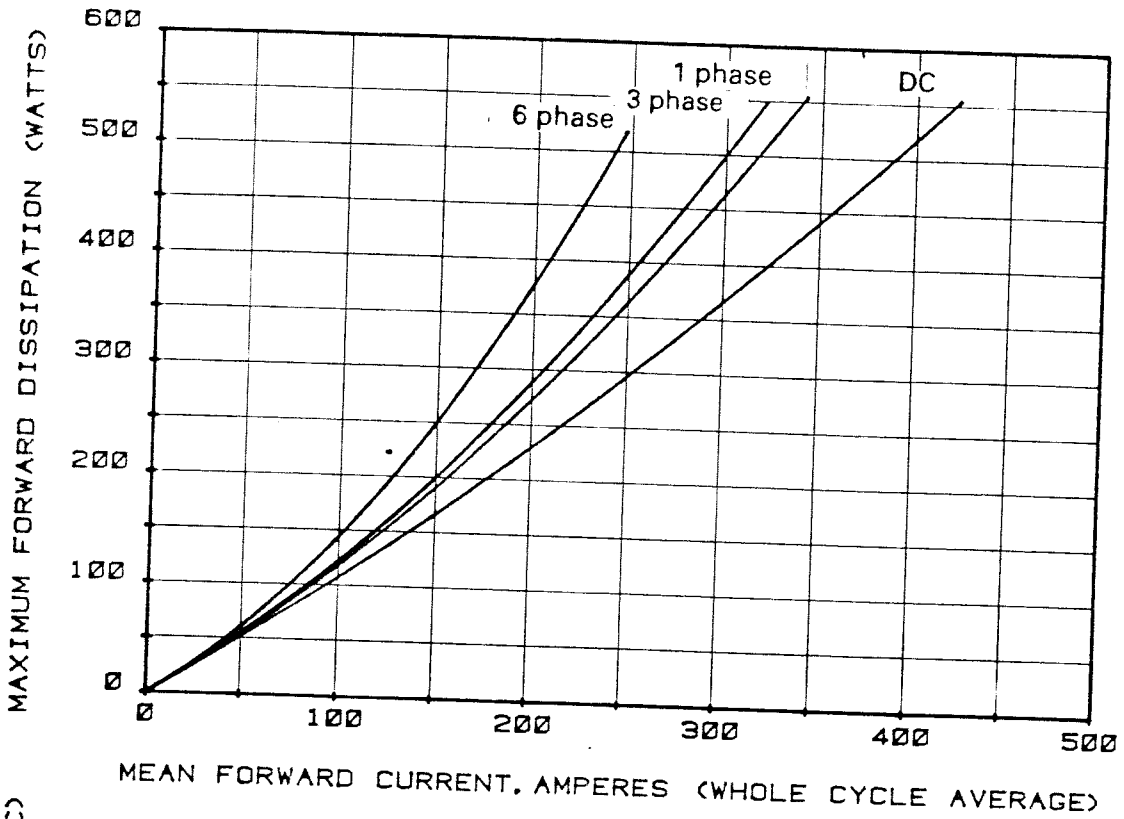

MAXIMUM RECOVERED CHARGE AT 125°C JUNCTION TEMPERATURE

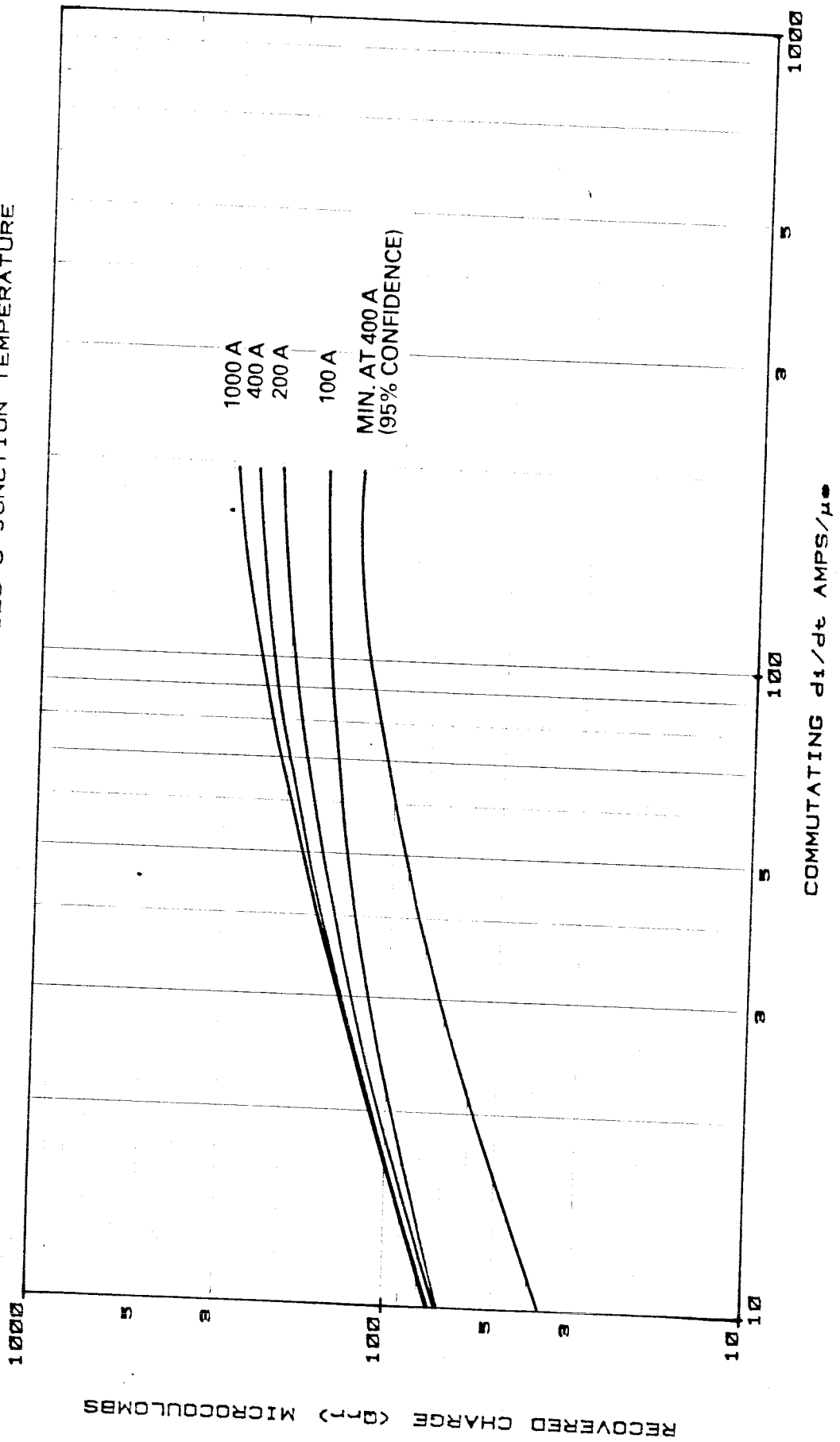

MINIMUM S FACTOR AT 125°C JUNCTION TEMPERATURE

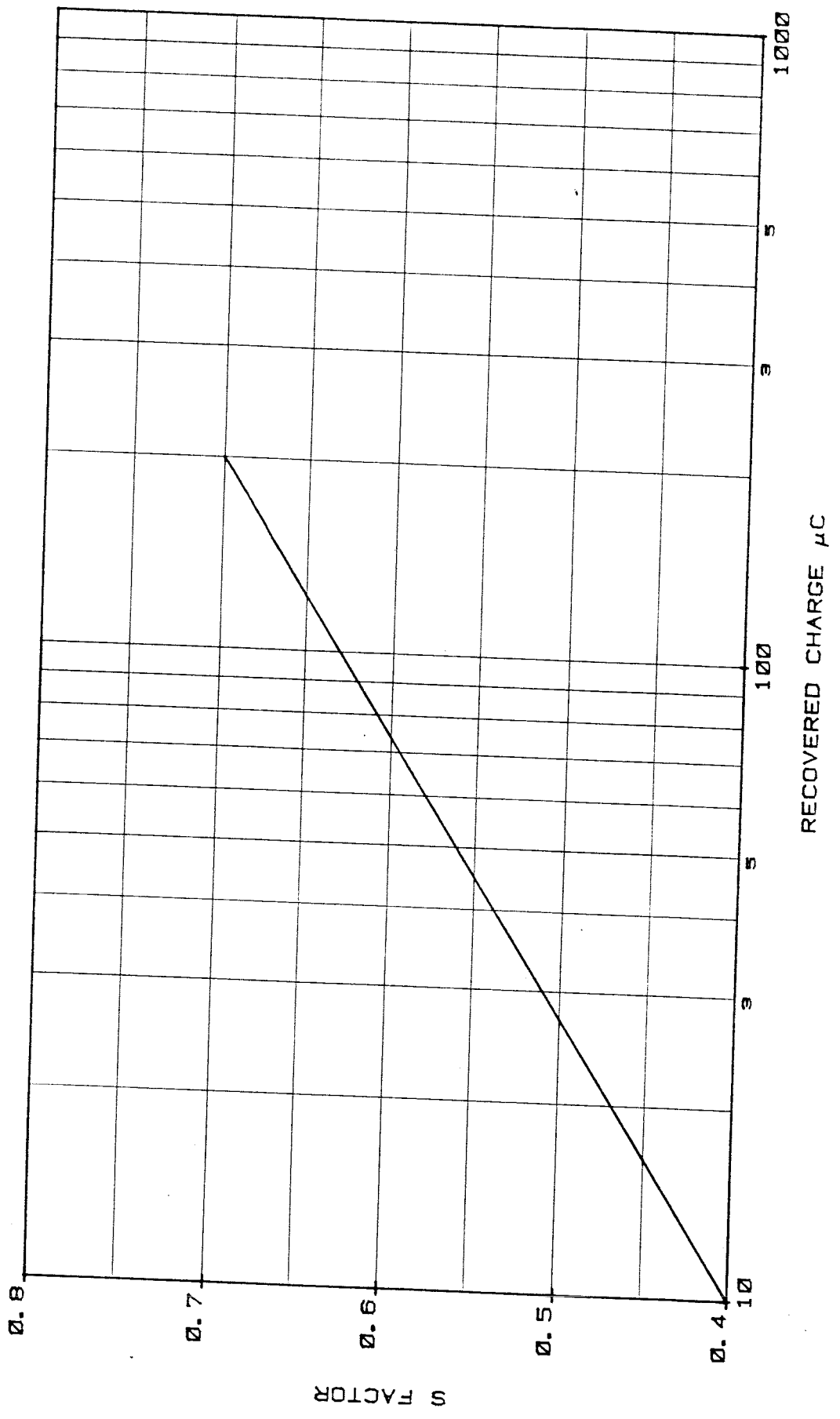

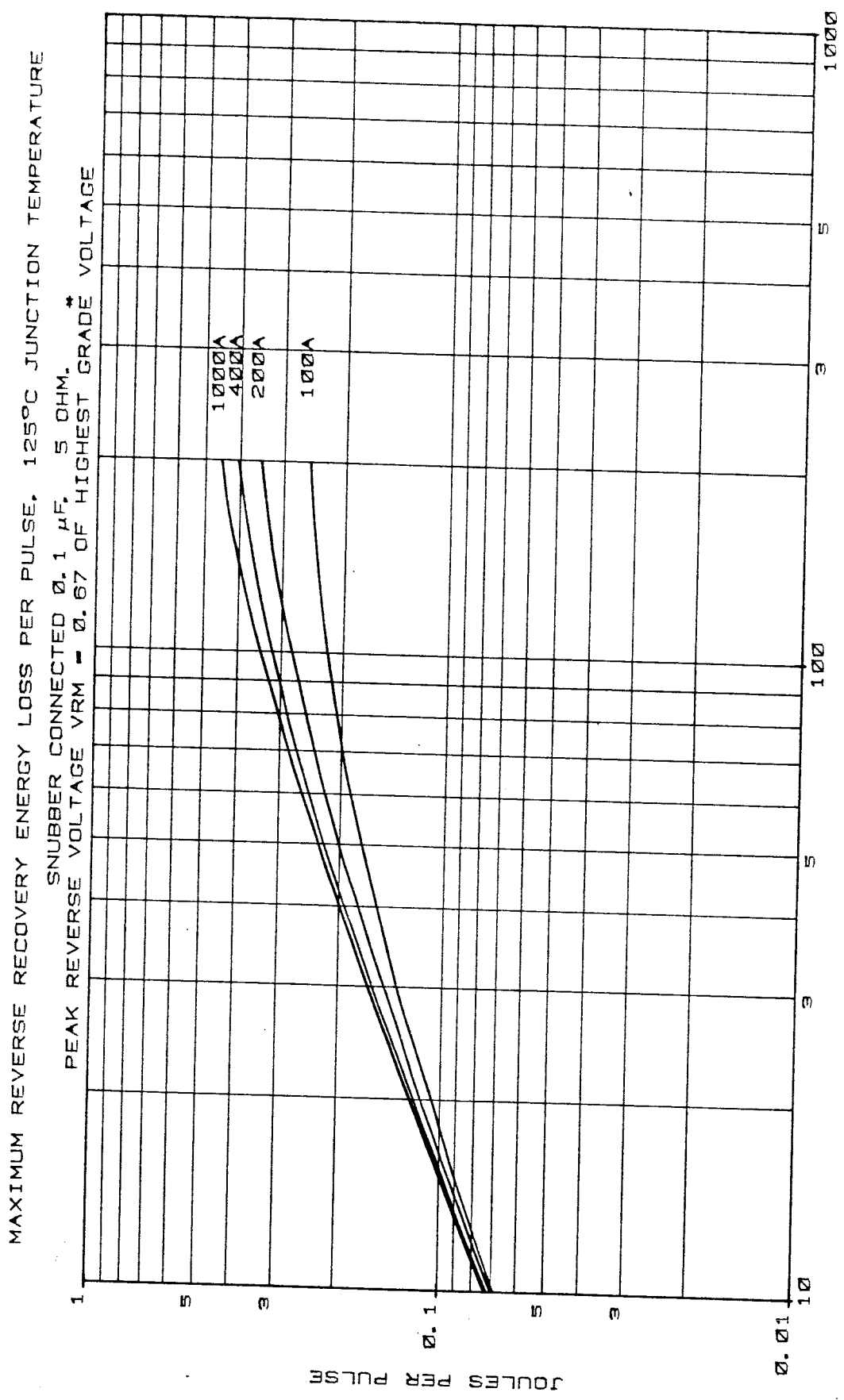

\* NOTE: ENERGY PER PULSE SHOULD BE ADJUSTED PRO RATA TO APPLIED PEAK RECOVERY VOLTAGE

COMMUTATING  $di/dt$  AMPS/μs

MAXIMUM JUNCTION TEMPERATURE RISE PER PULSE AT 125°C JUNCTION TEMPERATURE

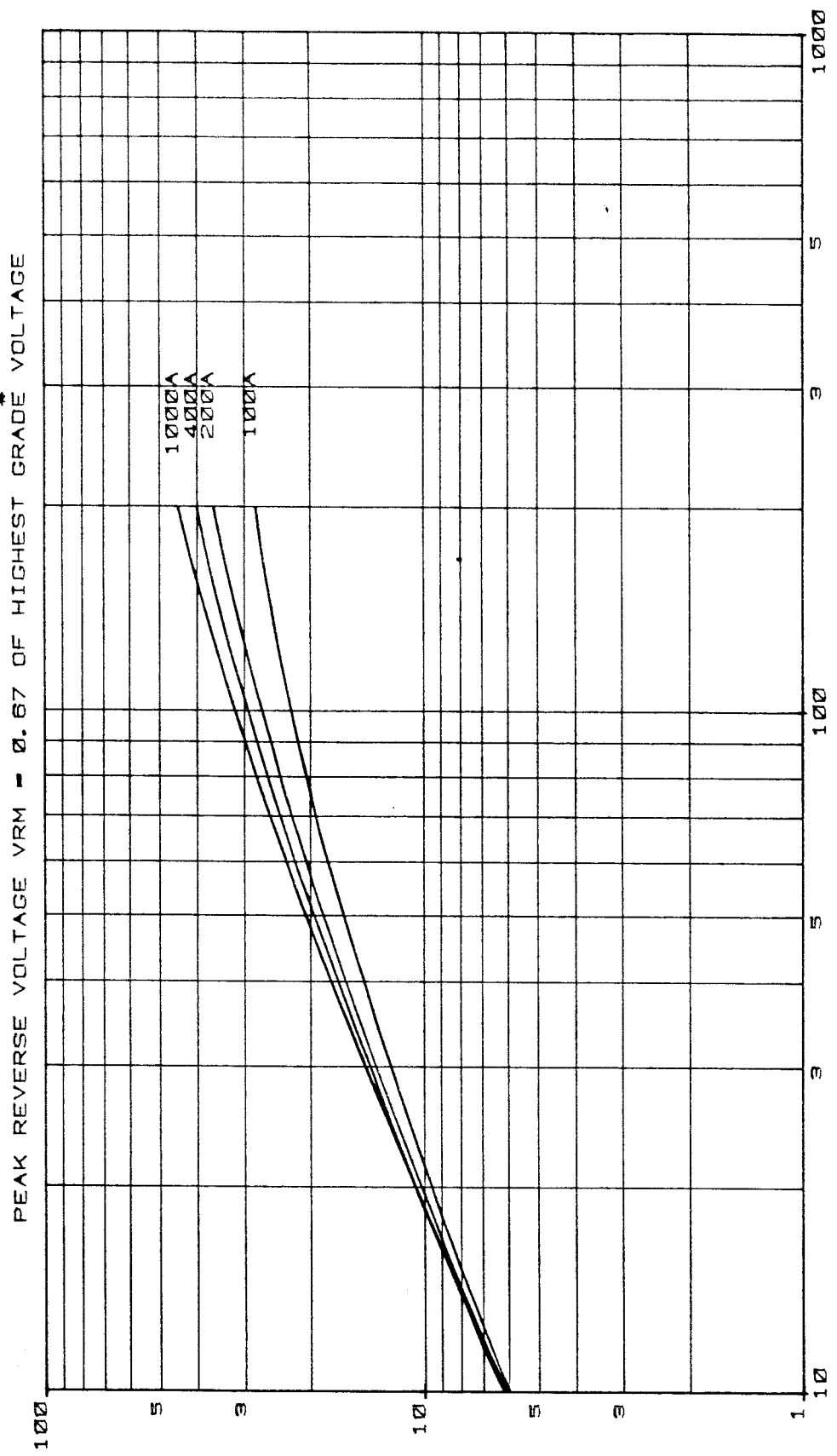

JUNCTION TEMPERATURE RISE PER PULSE

\* NOTE: T<sub>J</sub> RISE PER PULSE SHOULD BE ADJUSTED PRO RATA TO APPLIED PEAK RECOVERY VOLTAGE  
COMMUTATING di/dt AMPS/μs

T SINK 85°C. 200A/μe

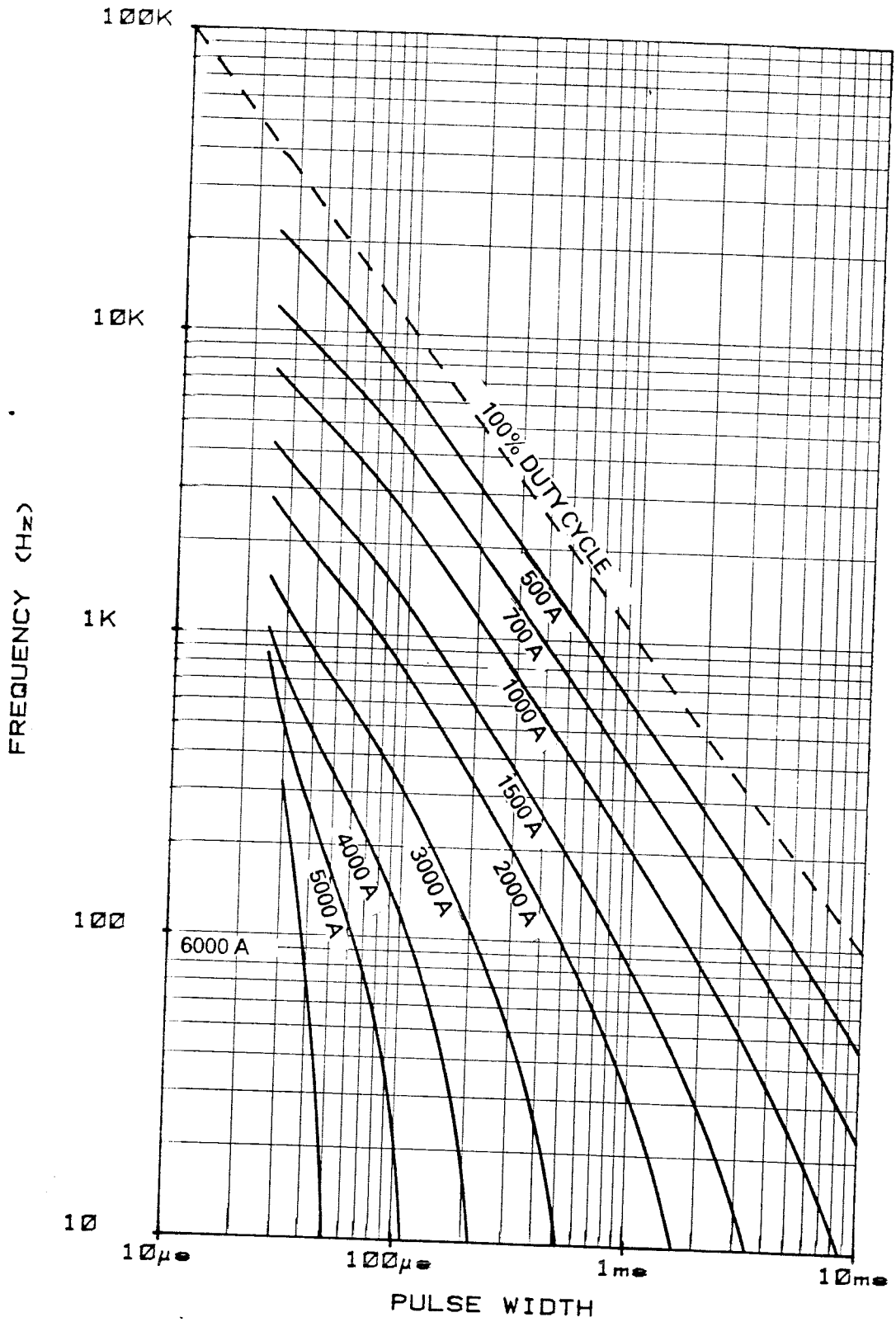

T SINK 55°C. 200A/μe

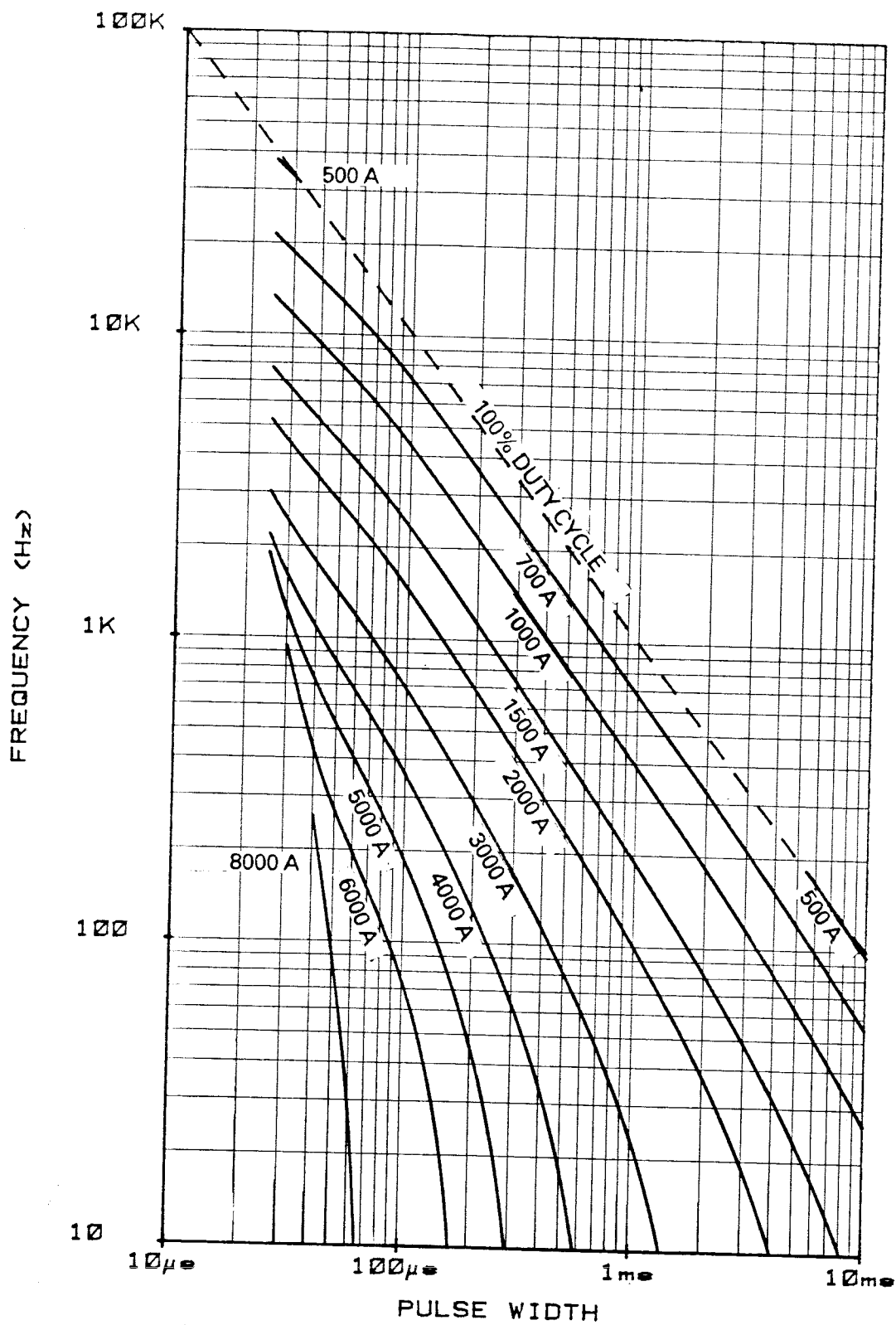

T SINK 85°C. 100A/μs

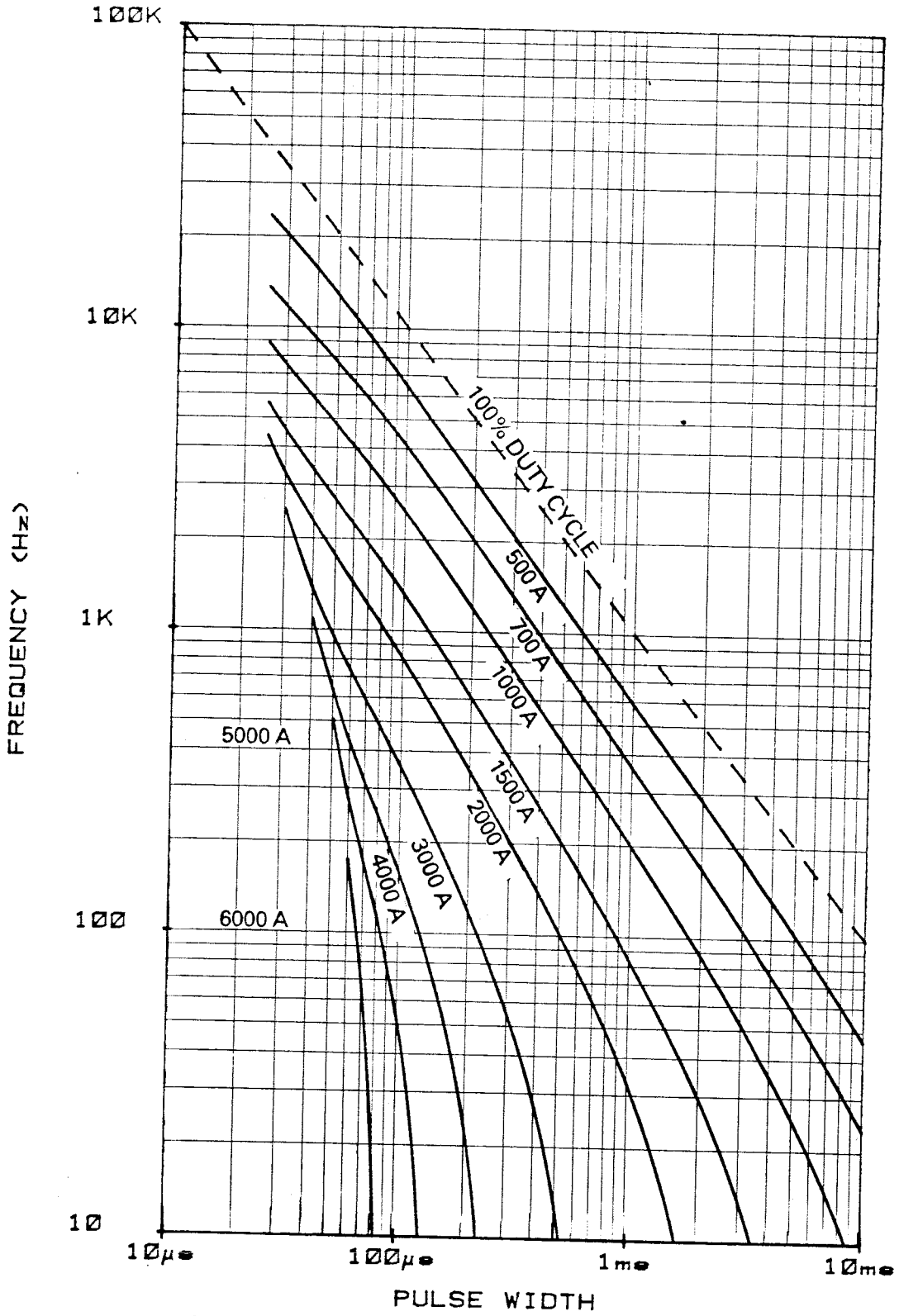

T SINK 55°C. 100A/μe

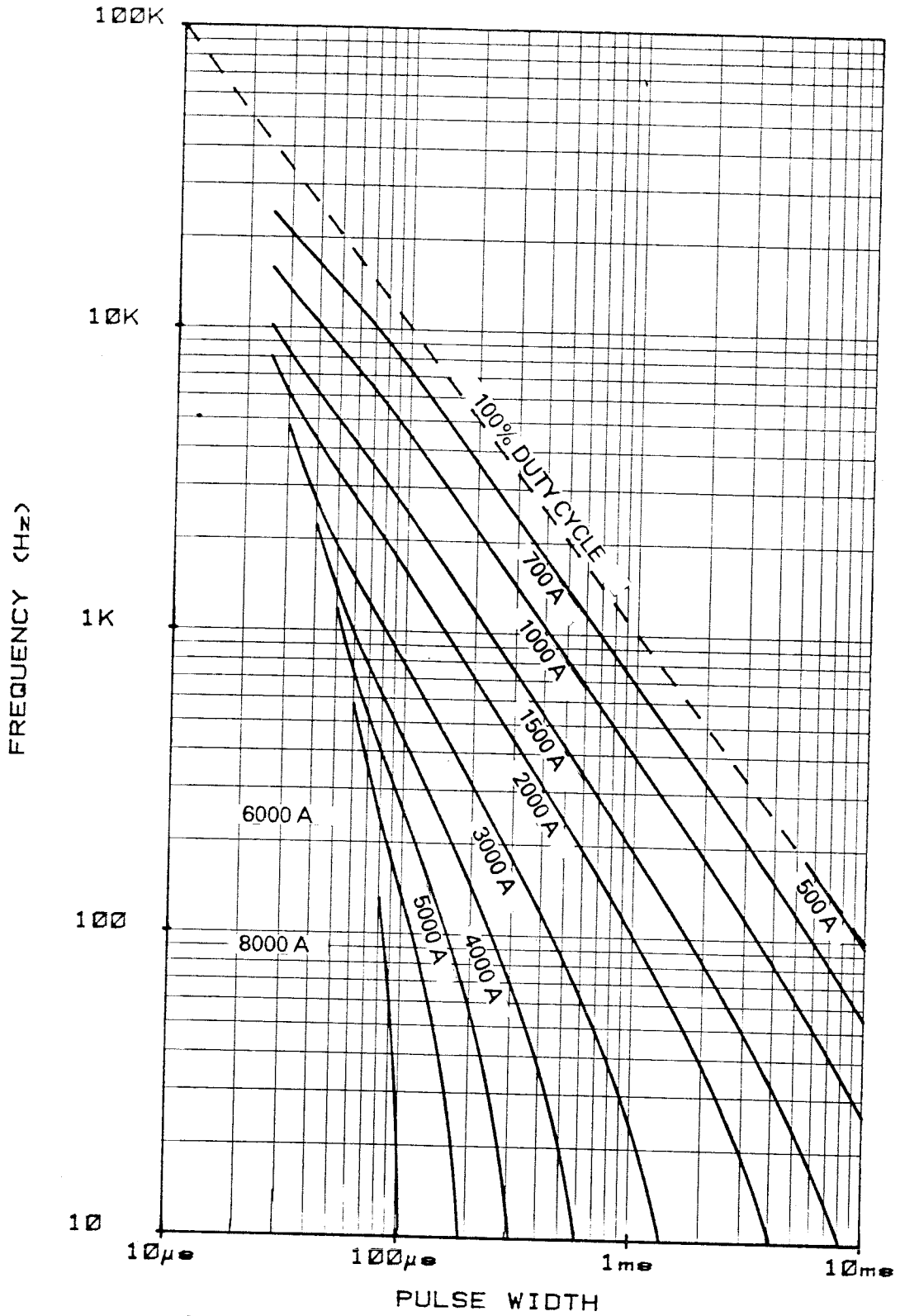

T<sub>J</sub> 125°C. 200A/μ•

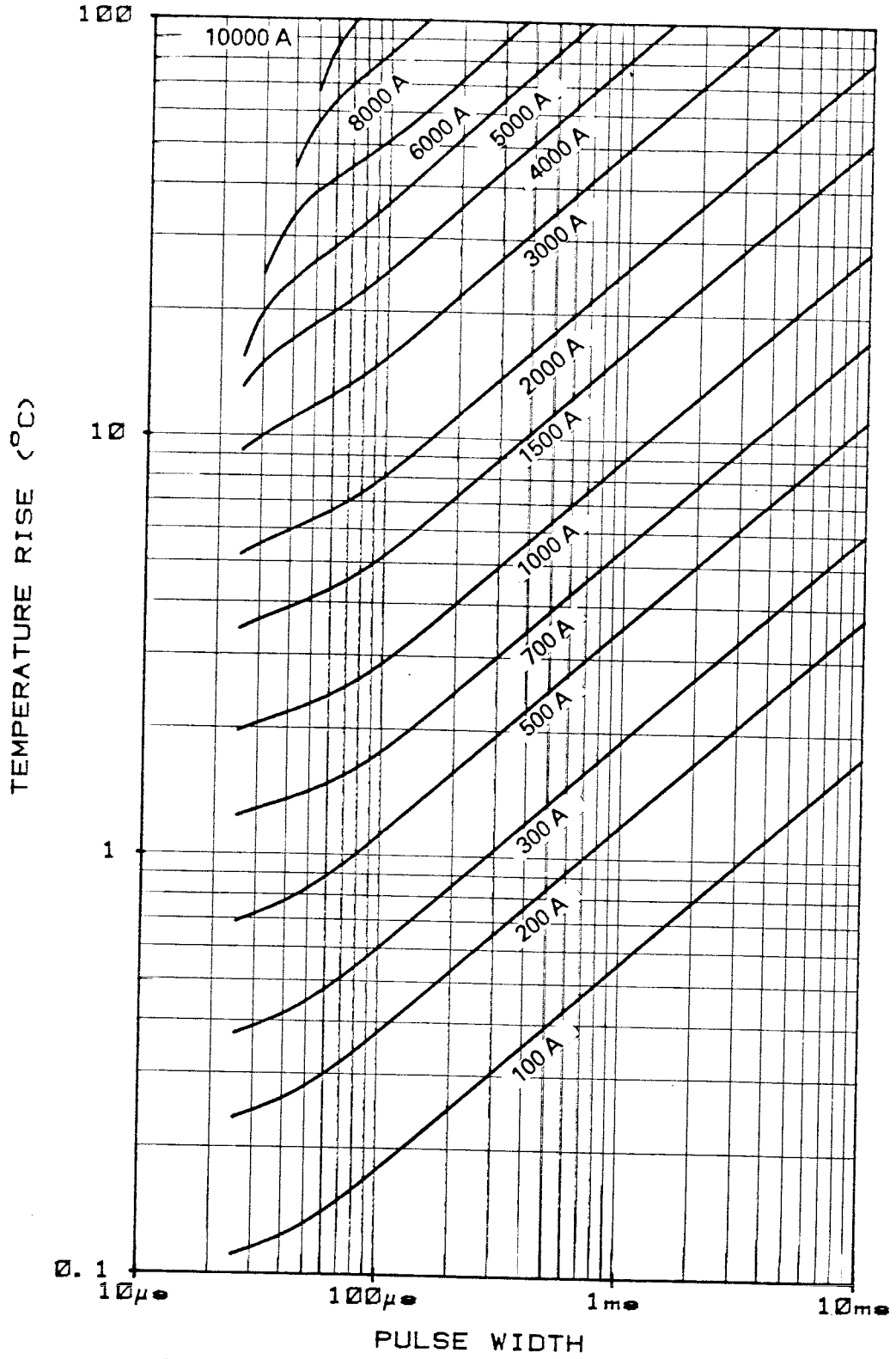

T<sub>J</sub> 125°C. 100A/μ•

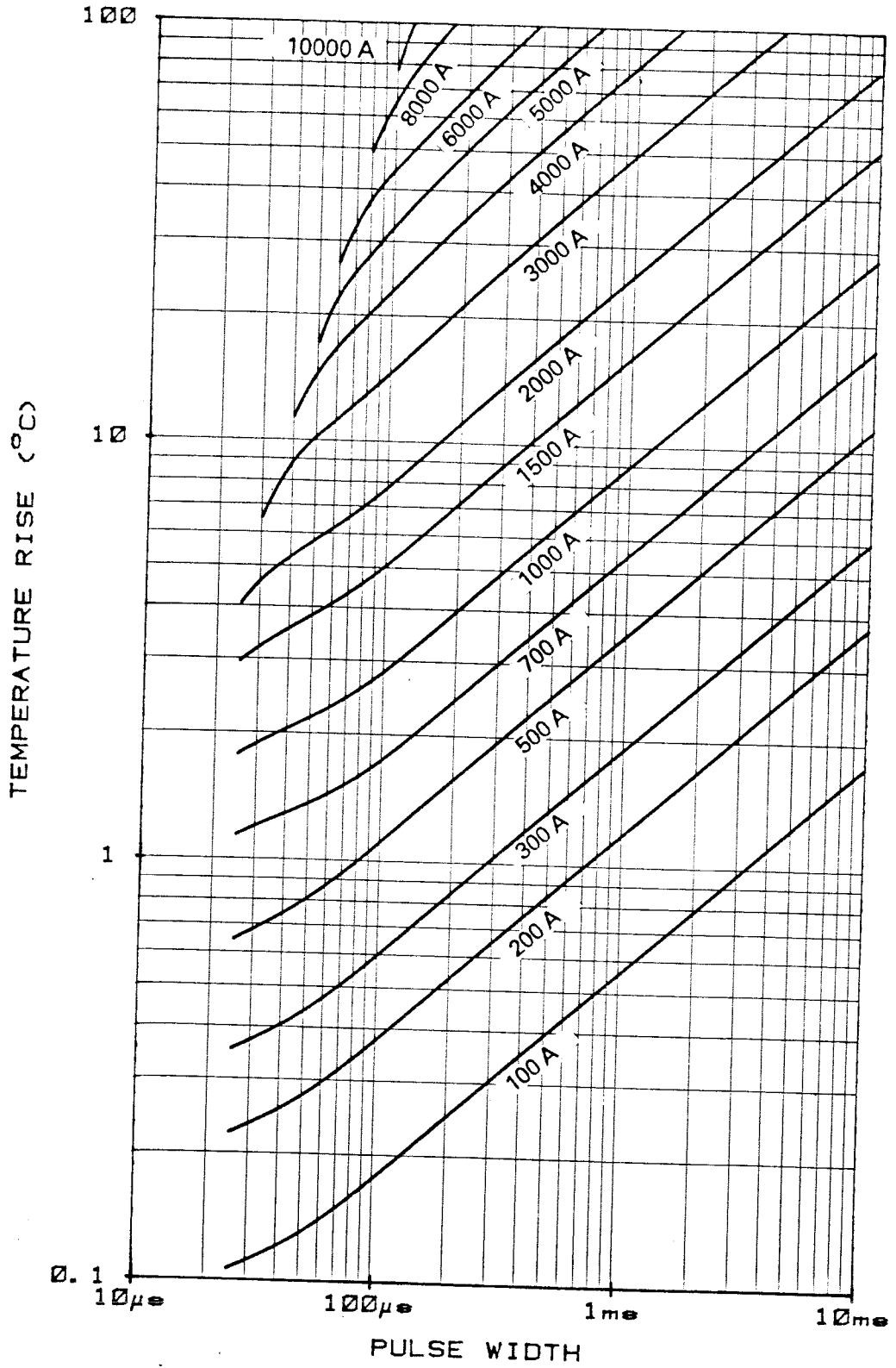

T<sub>J</sub> 125°C. 200A/μs

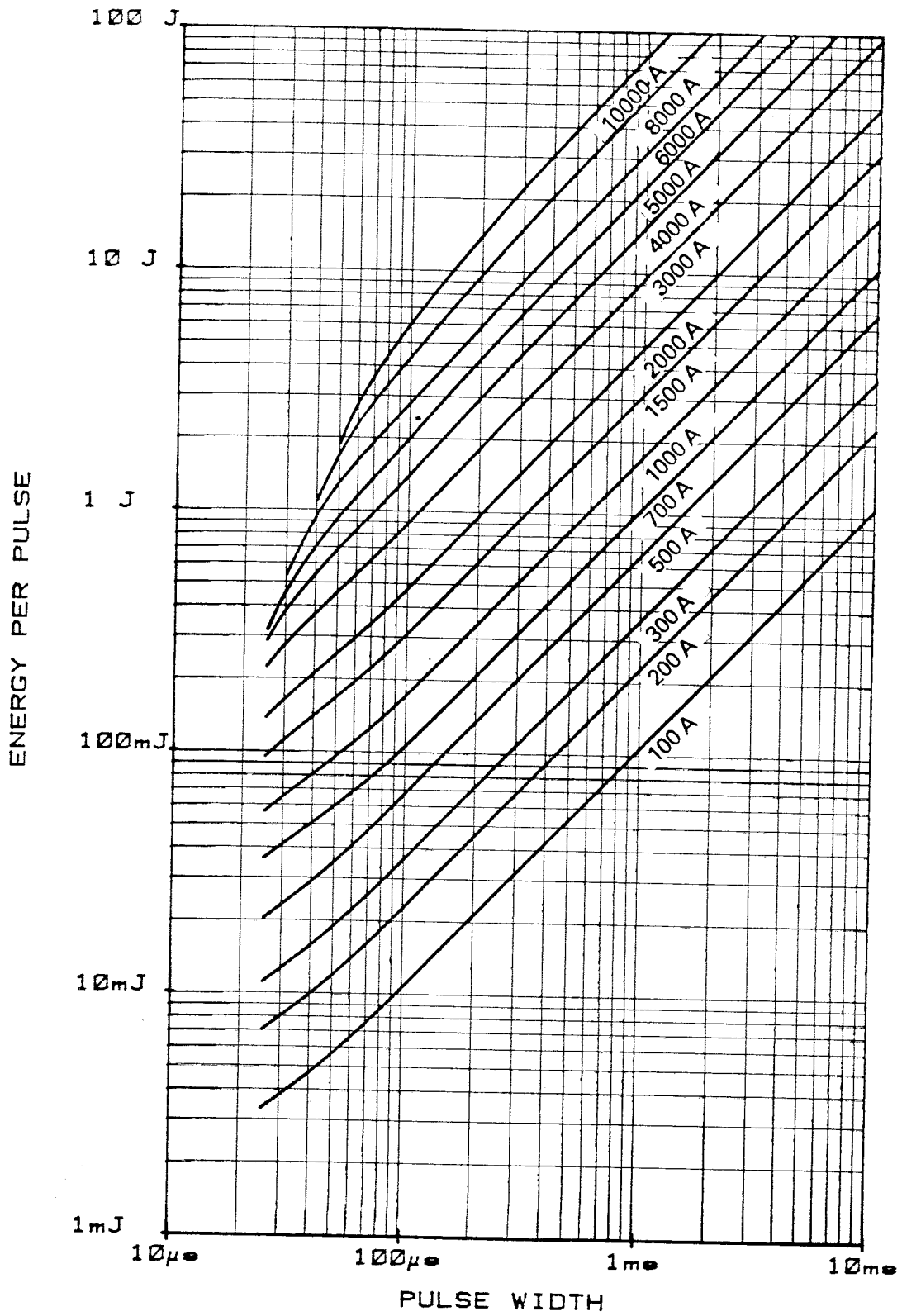

T<sub>J</sub> 125°C. 100A/μs

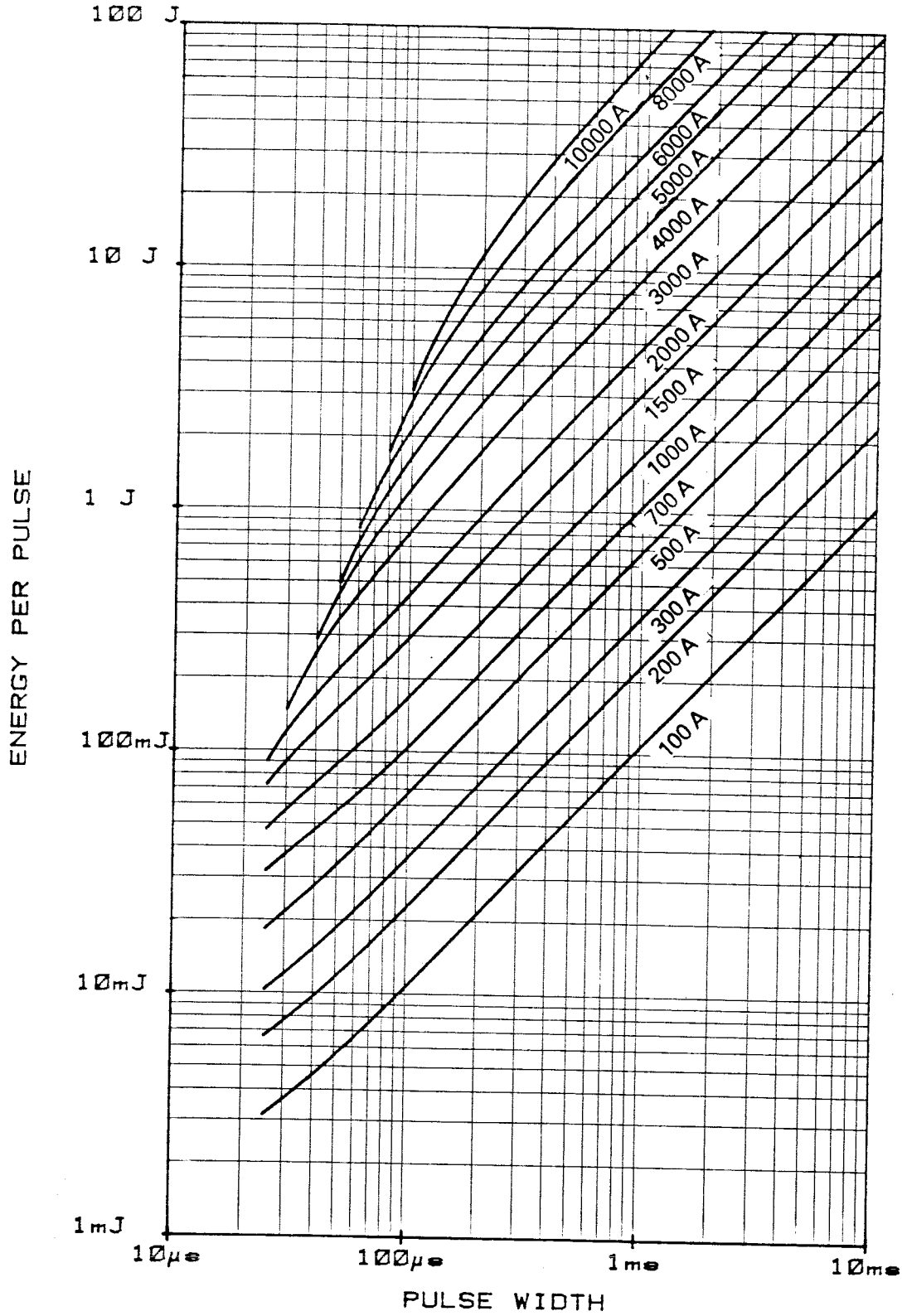

T SINK 85°C. SINE WAVE

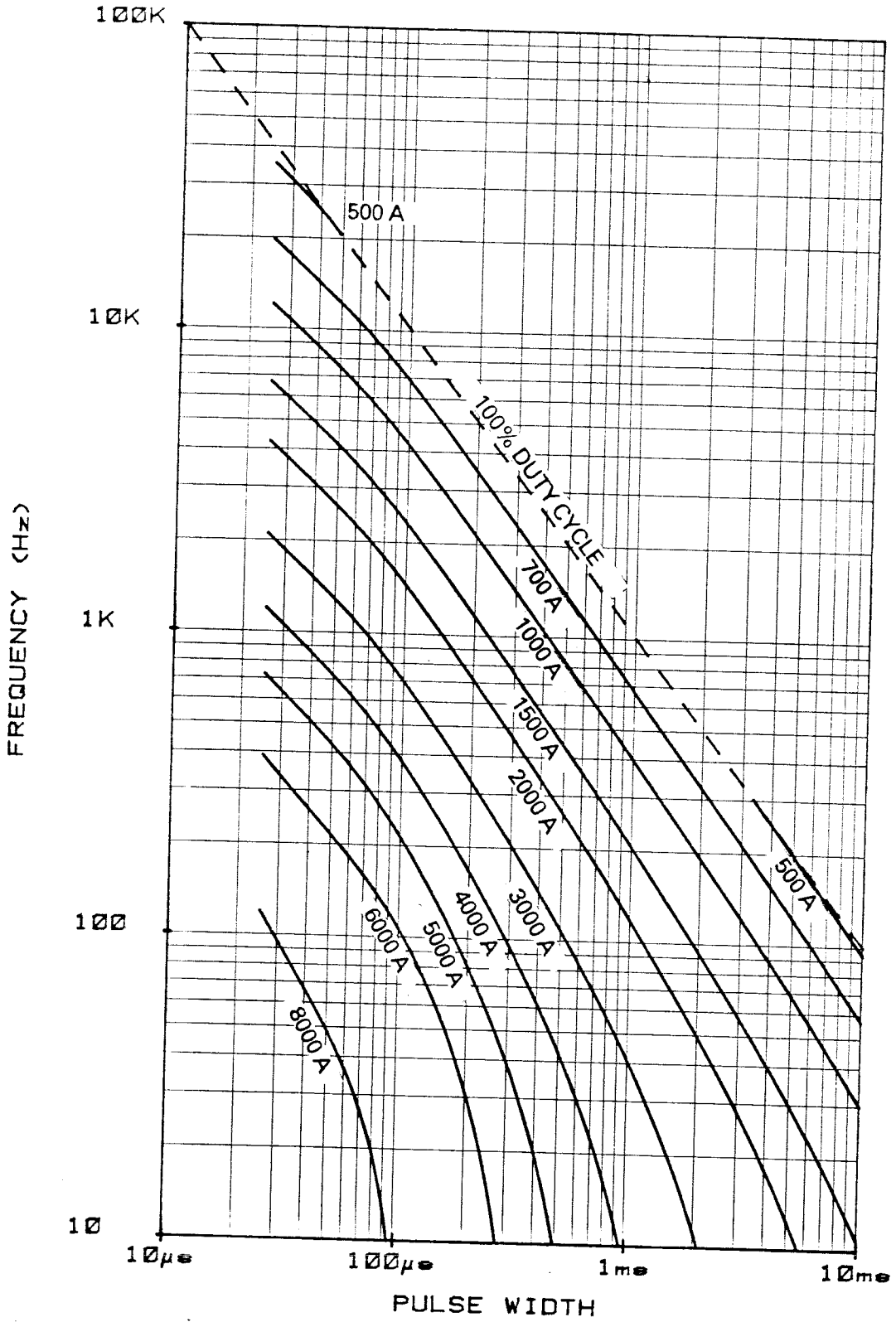

T SINK 55°C. SINE WAVE

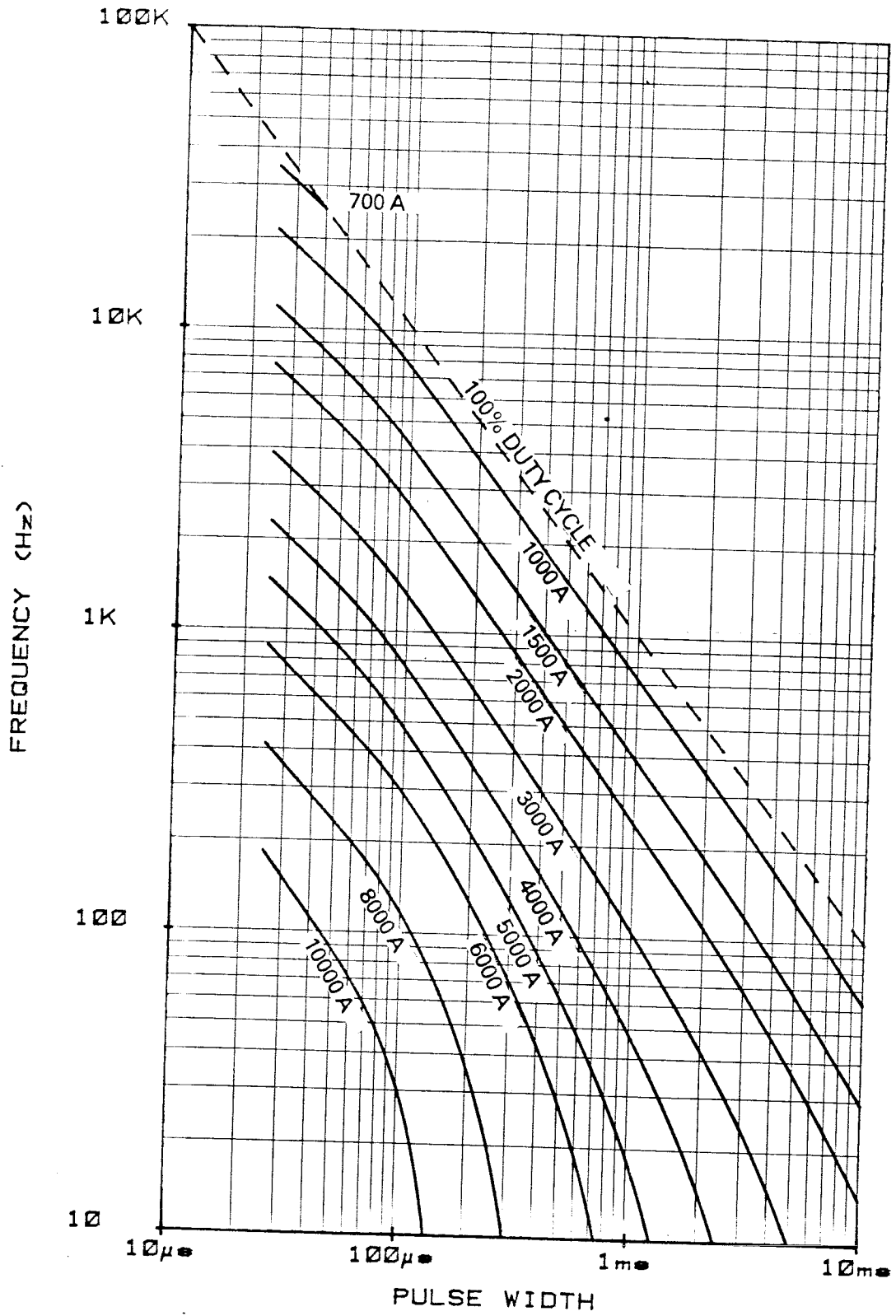

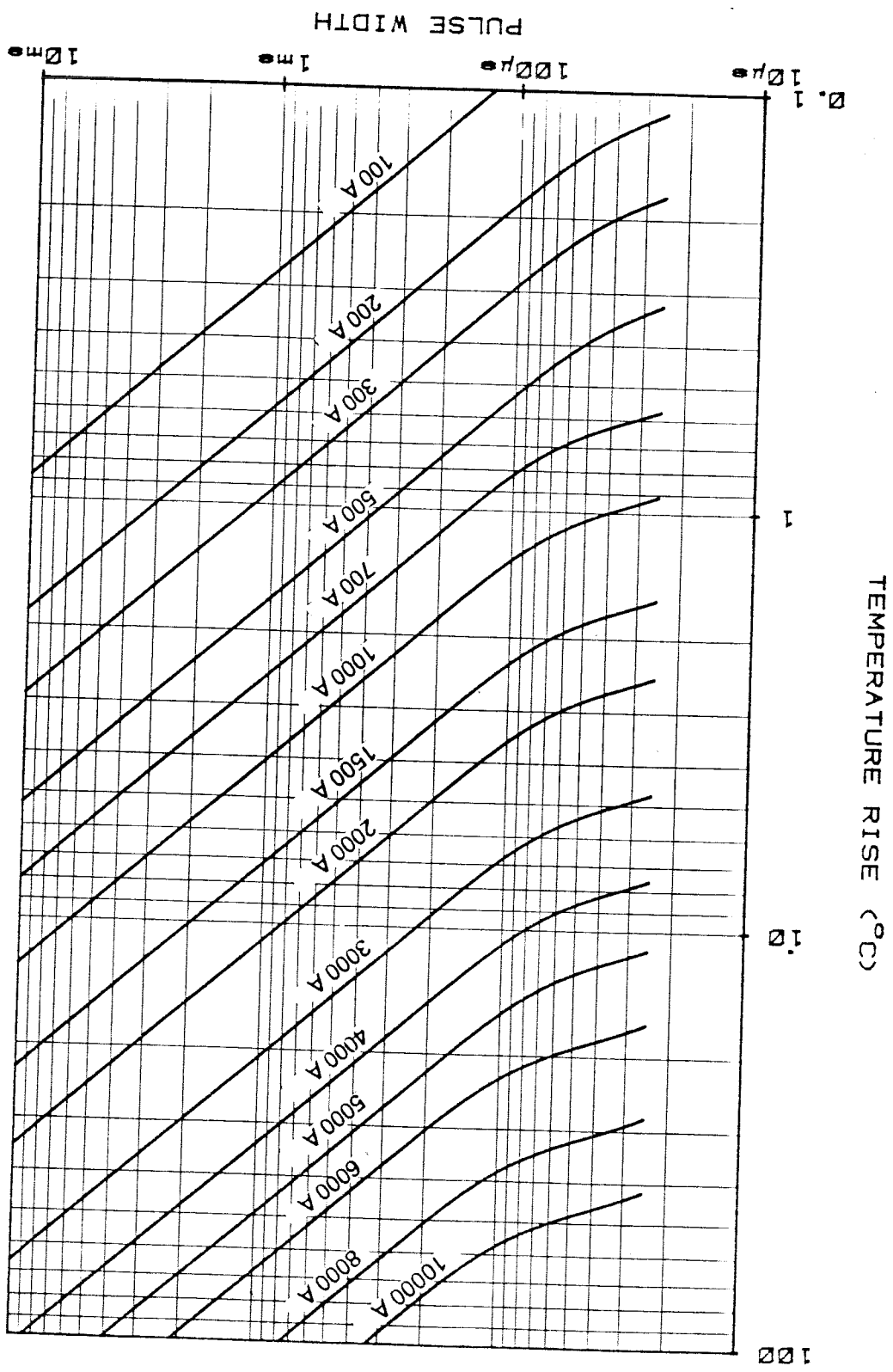

TJ 125°C. SINE WAVE

TJ 125°C. SINE WAVE

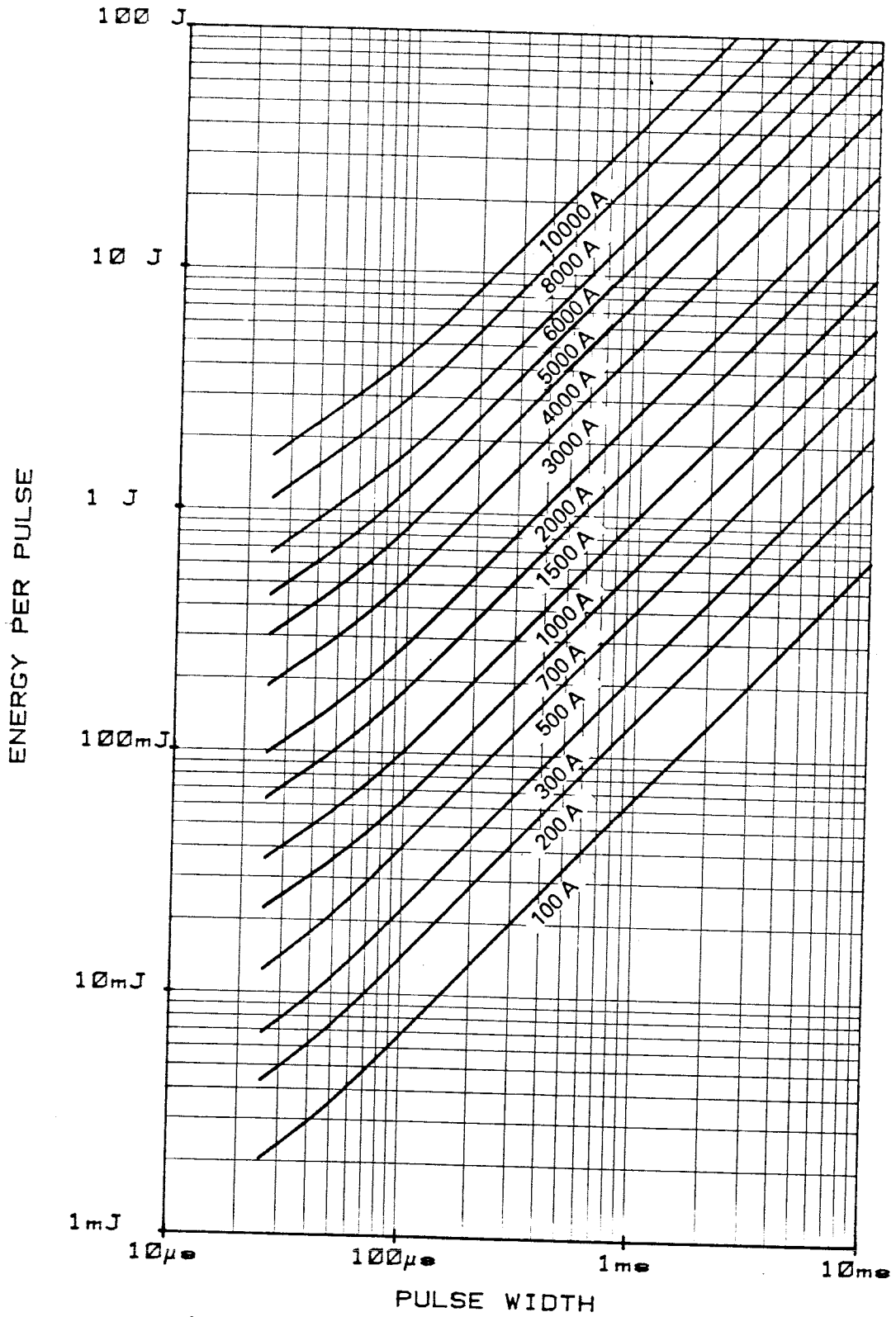

INTERNATIONAL OUTLINE NO. WEIGHT. 90 GRAMS L -28-

FINISH. NICKEL PLATE.

C176

DEVICE MARKING INCLUDES MONOGRAM, TYPE No., SPEC. No. AND POLARITY SYMBOL.

DEVICE MOUNTING: CLAMPING FORCE TO BE APPLIED ON 1/2 OF LOCATION HOLES AND BE EVENLY DISTRIBUTED OVER AREA OF CONTACT. FLAT TOL ON SURFACES TO WHICH DEVICE IS CLAMPED TO BE 0.04 WIDE.

CLAMPING FORCE = 330 - 550 kgf.

SUITABLE CLAMPS : BOX TYPE 101A226B, POWER CLAMP 101A260 SERIES.

G.A. DRG. No. 159B100H122

MIN	88
CHKD	88
APPD	
	A
S	N1

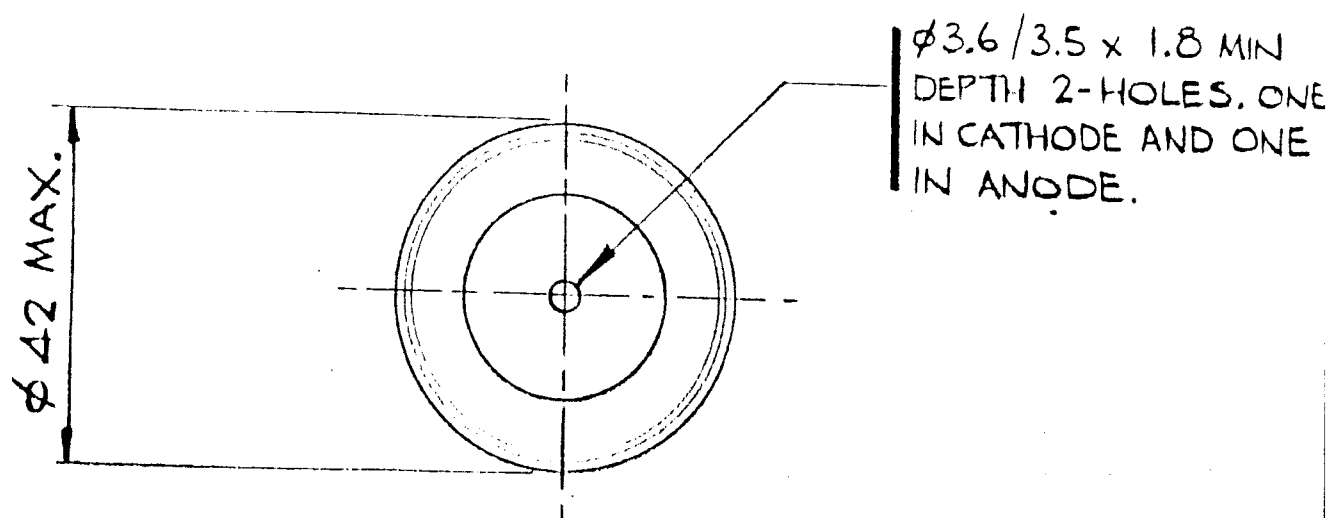

COMPRESSED HEIGHT.

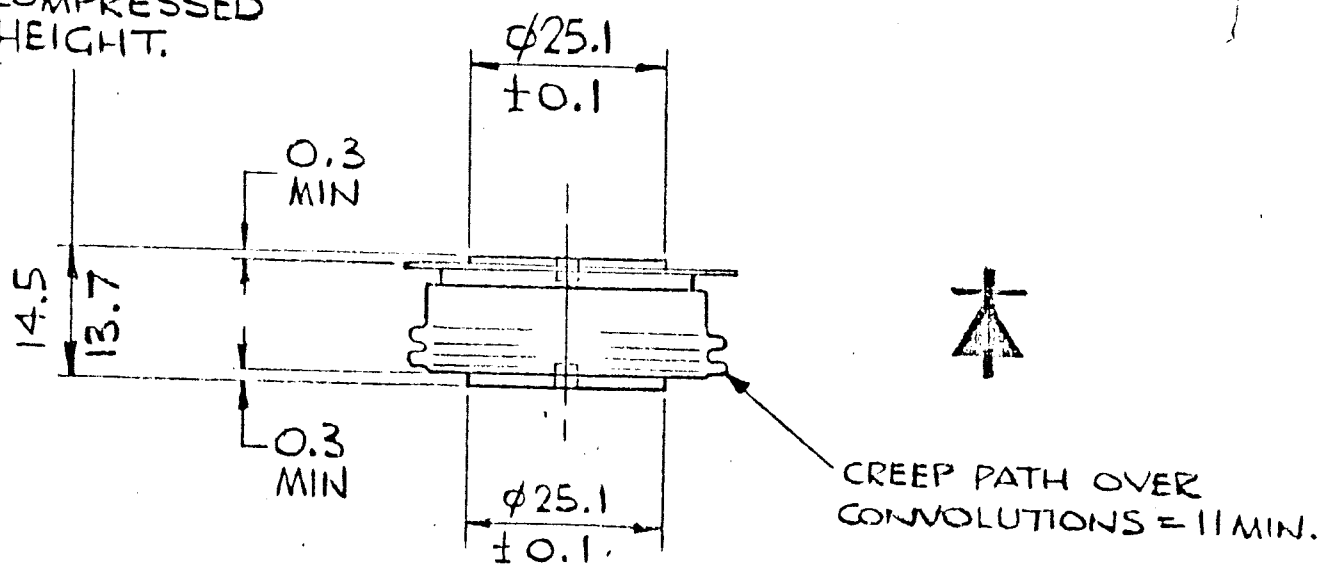

THE INFORMATION CONTAINED IN THIS DRAWING IS SUPPLIED IN CONFIDENCE AND IS PROTECTED BY COPYRIGHT. THE INFORMATION MAY NOT BE DISCLOSED EXCEPT WITH THE WRITTEN PERMISSION OF AND IN MANNER PERMITTED BY THE PROPRIETORS, WESTINGHOUSE BRAKE AND SIGNAL CO. LTD.

WESTINGHOUSE BRAKE AND SIGNAL CO. LTD. CHIPPENHAM, WILTSHIRE, SN15 1JD, ENGLAND.

WESTCODE<sup>®</sup> SEMICONDUCTORS

THIRD ANGLE PROJECTION

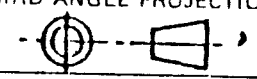

DIMNS. IN MILLIMETRES

DRG. No. 100A295

ISSI REVISIONS  
1 119.83 M1175