

---

**Boost or SEPIC DC-DC Controller**

---

**FEATURES**

- Wide Input Voltage Range: 2.7V to 5.5V
- Boost or SEPIC DC-DC Mode Controller
- VDD Under Voltage Lockout
- Build in over voltage Protect
- SOP-8 and SOT-23-6 Lead-free Package

**Applications**

- Handheld Electronics
- MR-16
- Lighting Divice

**GENERAL DESCRIPTION**

The T6331A are integrated, high-efficiency white or RGB LED drivers. They are designed for LED lighting applications.

The T6331A it can be used with boost or buck-boost (SEPIC) topologies. The constant-current outputs are single resistor or PWM programmable and the LED current can be adjusted.

The T6331A is available in SOP-8 and SOT-23-6 Lead-free package.

**PART NUMBER EXAMPLES**

<b>PART NO.</b>	<b>PACKAGE</b>
T6331A-AXG	SOT-23
T6331A-ADG	SOP-8

**PIN ARRANGEMENT(Top view)**

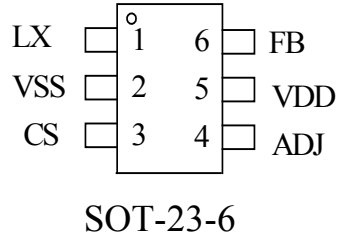
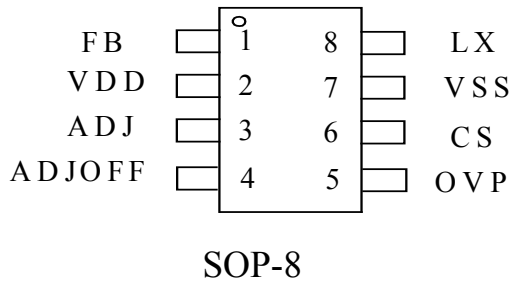

**PIN DESCRIPTION**

SYMBOL	SOP-8	SOT-23-6	DESCRIPTION
FB	1	6	Voltage Feed Back pin.
VDD	2	5	Power Supply
ADJ	3	4	Dimming pin
ADJOFF	4		ADJ-pin turn Off Voltage Level set pin
OVP	5		Over Voltage Protect
CS	6	3	Switch Current Sense
VSS	7	2	Ground
LX	8	1	Connected to external MOSFET gate pin

**ABSOLUTE MAXIMUM RATINGS**

Parameter	Symbol	Value	Unit
Voltage on any pin relative to GND	V <sub>IN</sub>	-0.3 to 7	V
Operating Temperature Rang	T <sub>A</sub>	-40 to +85	°C
Maximum Soldering Temperature (at leads, 10 sec)	T <sub>LEAD</sub>	300	°C
Storage Temperature Rang	T <sub>S</sub>	-65 to +150	°C
Continuous Power Dissipation ( T <sub>A</sub> = +70°C )	SOT-23	350	mW
	SOP-8	800	

**Electrical Characteristics**

(TA = -40 to 85°C unless otherwise noted. Typical values are at TA =25°C, VDD =5V)

Symbol	Description	Conditions	Min.	Typ.	Max	Unit
V <sub>DD</sub>	Operating voltage range	power supply input	2.7		5.5	V
V <sub>UVLO</sub>	VDD Under Voltage Lockout			2.7		V
V <sub>FB</sub>	FB pin voltage			0.15		V
t <sub>SW</sub>	Switching Frequency			500		KHz
I <sub>DD</sub>	Switch Off Current			300		uA
I <sub>OFF</sub>	ADJ turn off Current				30	uA
I <sub>LED</sub>	LED sink current	VDD = 2.7V~5.5V	RFB=1 ohm	150		mA
			RFB=0.214 ohm	700		mA
I <sub>LSD</sub>	LED leakage current in shutdown	V <sub>LED</sub> = 3.3V, VDD=0V, T <sub>A</sub> =+25°C			1	uA
I <sub>CS</sub>	CS pin Peak Switch Current	Limit= 0.1/Rcs , Rcs=0.05 ohm		2		A
V <sub>ADJ</sub>	External control voltage range	On ADJ pin for DC brightness control	0		1.2	V
V <sub>ADJOFF</sub>	Vadj OFF DC level (floating)	External resistor level =3.35uA Radjoff ,		0.2		V
V <sub>OVP</sub>	OVP Protect Reference Level	Over reference level to turn off		1.2		V
DPWMH	Duty cycle range of PWM signal applied to ADJ pin during high frequency PWM dimming mode	PWM frequency>1KHz PWM amplitude = VREF Measured on ADJ pin	0.16		1	
	Brightness control range			6:1		

**Functional Description**

The T6331A are integrated, high-efficiency white or RGB LED drivers. They are designed for LED lighting applications.

The T6331A it can be used with boost or buck-boost (SEPIC) topologies. The constant-current outputs are single resistor or PWM programmable and the LED current can be adjusted.

**Setting the Output Current**

FB controls the LED bias current. greater than the current flowing into RSET. Set the output current as follows:

$$I_{LED} = (0.15V / R_{FB})$$

**Output current adjustment by external DC control voltage**

The ADJ pin can be driven by an external dc voltage (V<sub>ADJ</sub>), as shown, to adjust the output current to a value above or below the nominal average value defined by R<sub>FB</sub>.

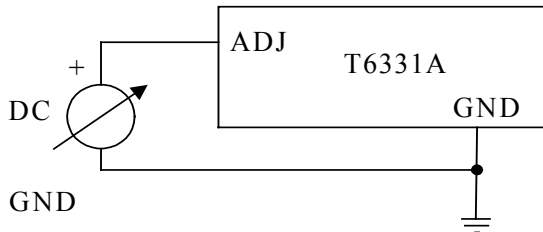

The nominal average output current in this case is given by:

$$I_{OUTdc} = (V_{ADJ} / 1.2) \times (0.15V / R_{FB}), \text{ [for } 0 < V_{ADJ} < 1.2V]$$

Note that 100% brightness setting corresponds to  $V_{ADJ} \geq V_{REF}$ . When driving the ADJ pin above 1.2V.

**Output current adjustment by PWM control**

**Directly driving ADJ input**

A Pulse Width Modulated (PWM) signal with duty cycle DP<sub>WM</sub> can be applied to the ADJ pin, as shown below, to adjust the output current to a value above or below the nominal average value set by resistor R<sub>FB</sub>:

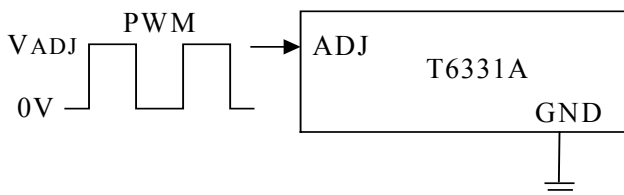

**Driving the ADJ input from a microcontroller**

Another possibility is to drive the device from the open drain output of a microcontroller. The diagram below shows one method of doing this:

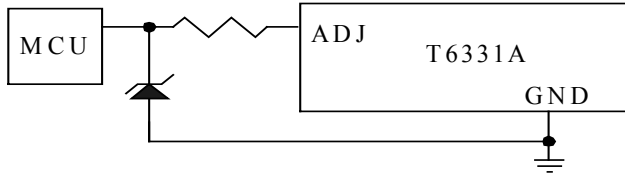

If the NMOS transistor within the microcontroller has high Drain / Source capacitance, this arrangement can inject a negative spike into ADJ input of the T6331A and cause erratic operation but the addition of a Schottky clamp diode (cathode to ADJ) to ground and inclusion of a series resistor (10K) will prevent this. See the section on PWM dimming for more details of the various modes of control using high frequency and low frequency PWM signals.

**Set ADJ Turn OFF Level**

ADJ OFF pin may set when dimming with ADJ turn off output minimum level. If usually ADJ OFF pin floating, then the ADJ internal default turn off output reference level is 0.2V, when therefore the ADJ dimming DC signal level is lower than 0.2V, then the output current will turn off. Therefore may simple a ADJ OFF external connection resistance to the GND, the ADJ turn off output level to the simple application change.

Set the V<sub>ADJ OFF</sub> DC level as follows:

$$V_{ADJ\ OFF\ DC\ level} = 3.35\mu A * R_{ADJ\ OFF}$$

**Over Voltage Protection**

Since T6331A is configured as current source, the output voltage rises as the output impedance increases or output is open-circuit (e.g. fault LED). The output voltage may exceed the maximum voltage rating of the internal and external main switch. An overvoltage protection circuit is integrated to prevent the main switch from burning. When the output voltage exceeds the OVP threshold voltage, the main switch is turned off. It remains off until the output voltage falls below the OVP threshold voltage. The step-up converter continues normal operation as long as the output voltage is under the OVP threshold. OVP pin reference voltage level is 1.2V.

**Peak Switch current Protection**

If external connection MOSFET the instantaneous switch current is large, over MOSFET the specification, then MOSFET will burn out, to prevent the instantaneous switch the large current, may use CS-pin to make the protection. CS pin Peak Switch Current Limit= 0.1/Rcs

**TYPICAL APPLICATION CIRCUITS**

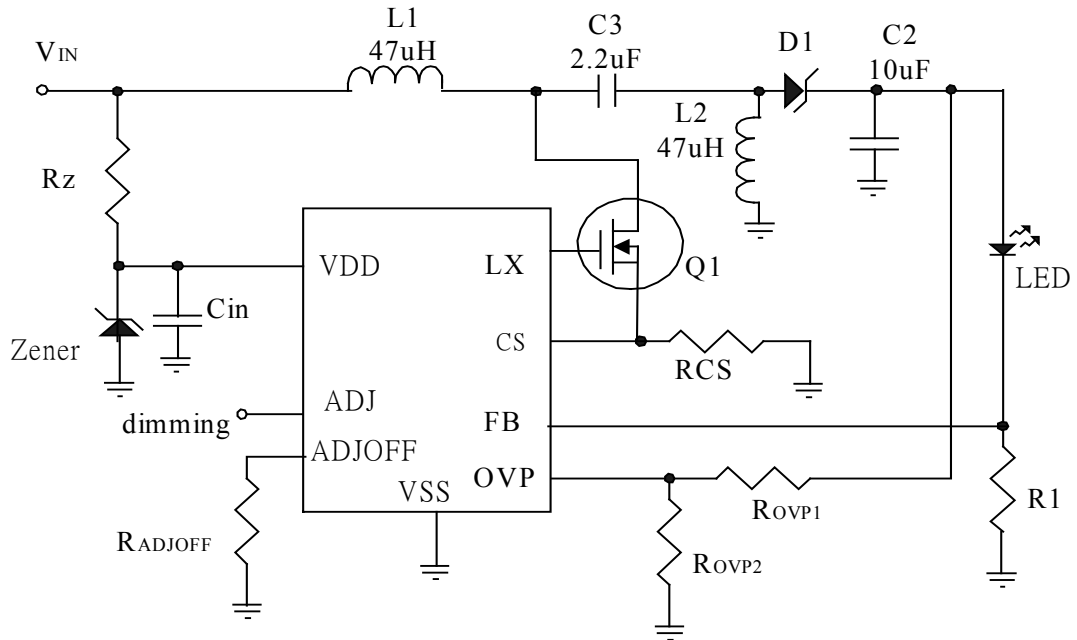

Note: \*R1 value is  $R_{FB} = 0.15V / I_{LED}$

Typical Application Circuit

**PACKAGE DIMENSIONS**  
**8-LEAD SOP**

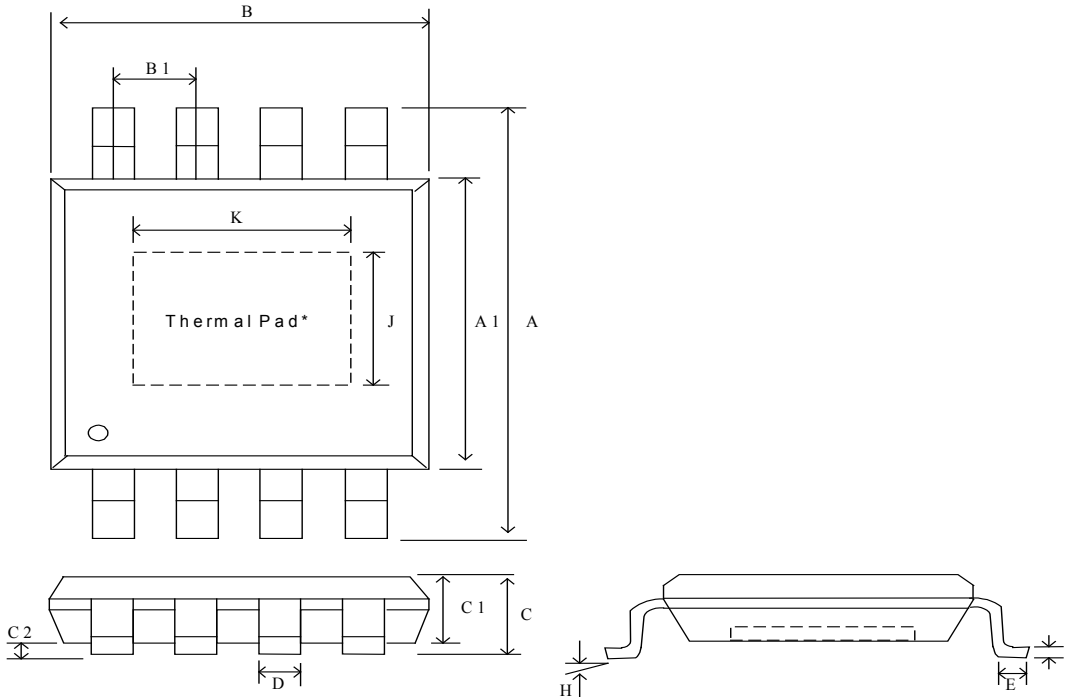

Symbol	Dimension in mm			Dimension in inch		
	Min.	Typ.	Max.	Min.	Typ.	Max.
A	5.70	6.00	6.30	0.224	0.236	0.248
A1	3.75	3.95	4.10	0.148	0.156	0.164
B	-	-	5.13	-	-	0.202
B1	-	1.27	-	-	0.050	-
C	-	-	1.80	-	-	0.071
C1	1.35	1.55	1.75	0.052	0.061	0.069
C2	0.10	-	0.25	0.001	-	0.004
D	0.31	0.41	0.51	0.012	0.016	0.020
E	0.30	0.50	0.70	0.012	0.020	0.028
F	0.10	0.15	0.25	0.004	0.006	0.010
J		2.23 REF			0.088 REF	
K		2.97 REF			0.117 REF	
H	0~8°			0~8°		

**\*Note :**

The thermal pad on the IC's bottom has to be mounted on the copper foil.

To eliminate the noise influence, the thermal pad is suggested to be connected to GND on PCB.

In addition, desired thermal conductivity will be improved, if a heat-conducting copper foil on PCB is soldered with thermal pad. The thermal pad enhances the power dissipation. As a result, a large amount of current can be sunk safely in one package.

**PACKAGE DIMENSIONS**  
**SOT23-6**

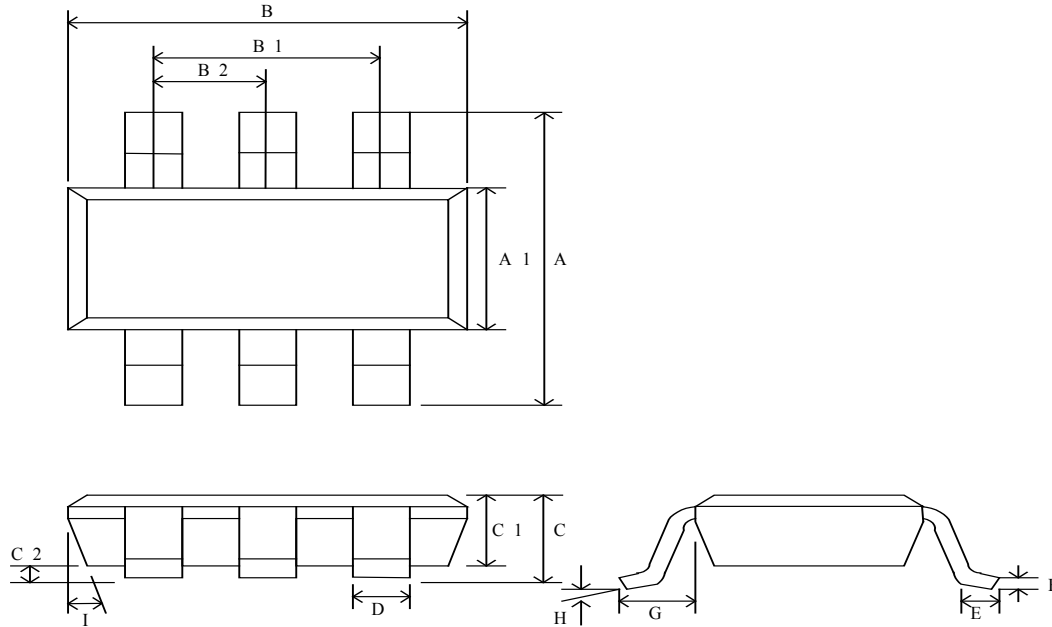

Symbol	Dimension in mm			Dimension in inch		
	Min.	Typ.	Max.	Min.	Typ.	Max.
A	2.60	2.80	3.00	0.102	0.110	0.118
A1	1.40	1.575	1.60	0.055	0.062	0.063
B	2.70	2.85	3.00	0.106	0.112	0.118
B1		1.90(BSC)			0.075(BSC)	
B2		0.95(BSC)			0.037(BSC)	
C	0.95	1.20	1.45	0.037	0.047	0.057
C1	0.90	1.10	1.30	0.035	0.043	0.051
C2	0	0.075	0.150	0	0.003	0.06
D		0.40			0.015	
E	0.30	0.45	0.60	0.012	0.018	0.023
F	0.08	0.15	0.22	0.003	0.006	0.009
G		0.60(REF)				
H				0~8°		
I	5~15°			5~15°		