



1.0 Hz to 102.4 kHz
8-Bit Programmable

Description

The D824 Series are digitally programmable low pass and high pass active filters with differential input that are tunable over a 256:1 frequency range. D824 filters are available with any one of five standard factory-set tuning ranges up to 102.4 kHz. These units contain 8 CMOS logic inputs .

All D824 Series models are convenient, low profile, easy to use fully finished filters which require no external components or adjustments. They feature low harmonic distortion, and near theoretical phase and amplitude characteristics. D824 filters operate from non-critical ± 12 to ± 18 Vdc power supplies, have a 10 k Ω (min.) input impedance, a 10 Ω (max.) output.

Features/Benefits:

- Compact 2" x 2" design minimizes board space requirements.
- Digitally programmable corner frequency allows selecting cut-off frequencies specific to each application.
- Plug-in ready-to-use, reducing engineering design and manufacturing cycle time.
- Factory-set tuning range, no external clocks or adjustments needed.
- Broad range of transfer characteristics and corner frequencies to meet a wide range of applications.

Applications

- Anti-alias filtering
- Data acquisition systems
- Communication systems and electronics
- Medical electronics equipment and research
- Aerospace, navigation and sonar applications
- Sound and vibration testing
- Real and compressed time data analysis
- Noise elimination
- Signal reconstruction

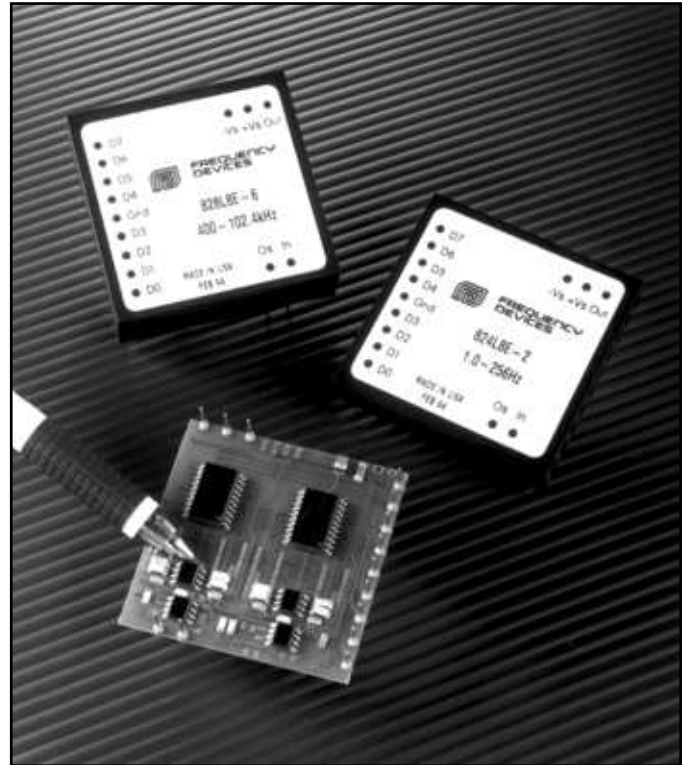

Programmable Specifications	Page
Digital Tuning & Control	2

Available Low-Pass Models:	
D824L8B 4-pole Butterworth	3
D824L8L 4-pole Bessel	3
D824L8Y2 4-pole Cheby (0.2 dB Ripple)	3
D824L8Y5 4-pole Cheby (0.5 dB Ripple)	3

Available High-Pass Models:	
D824H8B 4-pole Butterworth	4
D824H8Y2 4-pole Cheby (0.2 dB Ripple)	4
D824H8Y5 4-pole Cheby (0.5 dB Ripple)	4

General Specifications:	
Ordering information	5
Pin-out/package data	5



Digital Tuning & Control Characteristics

8-Bit Programmable Filters

Digital Tuning Characteristics

The digital tuning interface circuits are a parallel set of eight (8) 4053 CMOS switches which accept CMOS compatible inputs for the eight tuning bits (D₀ - D₇).

Filter tuning follows the tuning equation given below:

$$f_c = (f_{max}/256) [1 + D_7 \times 2^7 + D_6 \times 2^6 + D_5 \times 2^5 + D_4 \times 2^4 + D_3 \times 2^3 + D_2 \times 2^2 + D_1 \times 2^1 + D_0 \times 2^0]$$

where D₁ - D₇ = "0" or "1", and

f_{max} = Maximum tuning frequency;

f_c = corner frequency;

Minimum tunable frequency = f_{max}/256 (D₀ thru D₇ = 0);

Minimum frequency step (Resolution) = f_{max}/256

Data Input Specifications

Input Data Levels (CMOS Logic)

Input Voltage (V_s = 15 Vdc)

Low Level In	0 Vdc min.	4 Vdc max.
High Level In	11 Vdc min.	15 Vdc max.

Input Current

High Level In	- 10 ⁻⁵ μA typ.	-1 μA max..
Low Level In	+10 ⁻⁵ μA typ.	+1 μA max.

Input Capacitance 5 pF typ 7.5 pF max.

Input Data Format Frequency Select Bits

Positive Logic Logic "1" = +V_s
Logic "0" = Gnd

Bit Weighting (Binary-Coded)
D₀ LSB (least significant bit)
D₇ MSB (most significant bit)

Frequency Range 256 : 1, Binary Weighted

Pin-Out Key

IN	Analog Input Signal	D ₇ Tuning Bit 7 (MSB)
OUT	Analog Output Signal	D ₆ Tuning Bit 6
GND	Power and Signal Return	D ₅ Tuning Bit 5
+V _s	Supply Voltage, Positive	D ₄ Tuning Bit 4
-V _s	Supply Voltage, Negative	D ₃ Tuning Bit 3
Os	Offset Adjustment	D ₂ Tuning Bit 2
		D ₁ Tuning Bit 1
		D ₀ Tuning Bit 0 (LSB)

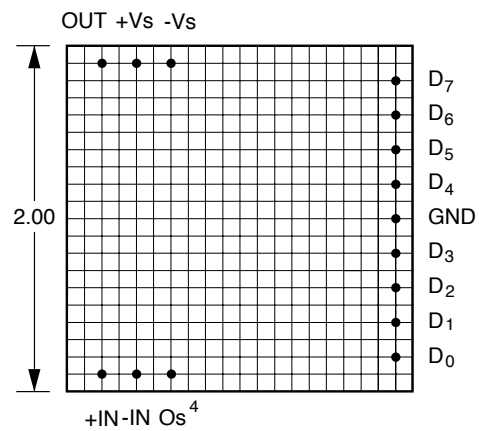

Bottom View

MSB	---	---	---	---	---	---	LSB	Bit Weight
D ₇	D ₆	D ₅	D ₄	D ₃	D ₂	D ₁	D ₀	f _c Corner Frequency
0	0	0	0	0	0	0	0	f _{max} /256
0	0	0	0	0	0	0	1	f _{max} /128
0	0	0	0	0	0	1	1	f _{max} /64
0	0	0	0	0	1	1	1	f _{max} /32
0	0	0	0	1	1	1	1	f _{max} /16
0	0	0	1	1	1	1	1	f _{max} /8
0	0	1	1	1	1	1	1	f _{max} /4
0	1	1	1	1	1	1	1	f _{max} /2
1	1	1	1	1	1	1	1	f _{max}



8-Bit Programmable

4-Pole Low-Pass Filters

Model	D824L8B	D824L8L	D824L8Y2	D824L8Y5
Product Specifications				
Transfer Function	4-Pole, Butterworth	4-Pole, Bessel	4-Pole, Chebychev, 0.2 dB Ripple	4-Pole, Chebychev, 0.5 dB Ripple
Size, Model 2 Model 3 thru 6	2.0" x 2.0" x 0.5" 2.0" x 2.0" x 0.4"	2.0" x 2.0" x 0.5" 2.0" x 2.0" x 0.4"	2.0" x 2.0" x 0.5" 2.0" x 2.0" x 0.4"	2.0" x 2.0" x 0.5" 2.0" x 2.0" x 0.4"
Range f_c	1.0 Hz to 102.4 kHz	1.0 Hz to 102.4 kHz	1.0 Hz to 102.4 kHz	1.0 Hz to 102.4 kHz
Theoretical Transfer Characteristics	Appendix A Page 7	Appendix A Page 2	Appendix A Page 12	Appendix A Page 15
Passband Ripple (theoretical)	0.0 dB	0.0 dB	0.20 dB	0.50 dB
DC Voltage Gain (non-inverting)	0 ± 0.1 dB max. 0 ± 0.05 dB typ.	0 ± 0.1 dB max. 0 ± 0.05 dB typ.	0 ± 0.1 dB max. 0 ± 0.05 dB typ.	0 ± 0.1 dB max. 0 ± 0.05 dB typ.
Stopband Attenuation Rate	24 dB/octave	24 dB/octave	24 dB/octave	24 dB/octave
Cutoff Frequency Stability Amplitude Phase	f_c ± 2% max. ± 0.01% /°C -3 dB -180°	f_c ± 2% max. ± 0.01% /°C -3 dB -121°	f_c ± 2% max. ± 0.01% /°C -3 dB -231°	f_c ± 2% max. ± 0.01% /°C -3 dB -245°
Filter Attenuation (theoretical)	0.67 dB 0.80 f_c 3.01 dB 1.00 f_c 30.0 dB 2.37 f_c 40.0 dB 3.16 f_c	1.86 dB 0.80 f_c 3.01 dB 1.00 f_c 30.0 dB 3.50 f_c 40.0 dB 4.72 f_c	-0.20 dB 0.80 f_c 3.01 dB 1.00 f_c 30.0 dB 1.89 f_c 40.0 dB 2.46 f_c	-0.43 dB 0.80 f_c 3.01 dB 1.00 f_c 30.0 dB 1.80 f_c 40.0 dB 2.33 f_c
Phase Match¹	0 - 0.8 f_c ± 2° max. ± 1° typ. 0.8 f_c - 1.0 f_c ± 3° max. ± 1.5° typ.	0 - f_c ± 2° max. ± 1° typ.	0 - 0.8 f_c ± 2° max. ± 1° typ. 0.8 f_c - 1.0 f_c ± 3° max. ± 1.5° typ.	0 - 0.8 f_c ± 2° max. ± 1° typ. 0.8 f_c - 1.0 f_c ± 3° max. ± 1.5° typ.
Amplitude Accuracy (theoretical)	0 - 0.8 f_c ± 0.2 dB max. ± 0.1 dB typ. 0.8 f_c - 1.0 f_c ± 0.3 dB max. ± 0.15 dB typ.	0 - f_c ± 0.2 dB max. ± 0.1 dB typ.	0 - 0.8 f_c ± 0.2 dB max. ± 0.1 dB typ. 0.8 f_c - 1.0 f_c ± 0.3 dB max. ± 0.15 dB typ.	0 - 0.8 f_c ± 0.2 dB max. ± 0.1 dB typ. 0.8 f_c - 1.0 f_c ± 0.3 dB max. ± 0.15 dB typ.
Total Harmonic Distortion @ 1 kHz	< - 100 dB typ.	< - 100 dB typ.	< - 88 dB typ.	< - 88 dB typ.
Wide Band Noise (5 Hz - 2 MHz)	200 μ Vrms typ.	200 μ Vrms typ.	200 μ Vrms typ.	200 μ Vrms typ.
Narrow Band Noise (5 Hz - 100 kHz)	50 μ Vrms typ.	50 μ Vrms typ.	50 μ Vrms typ.	50 μ Vrms typ.

1. Unit to unit match for the same transfer function, set to the same frequency and operating configuration, and from the same manufacturing lot.



8-Bit Programmable

4-Pole High-Pass Filters

Model	D824H8B	D824H8Y2	D824H8Y5	
Product Specifications				
Transfer Function	4-Pole, Butterworth	4-Pole, Chebychev, 0.2 dB Ripple	4-Pole, Chebychev, 0.5 dB Ripple	
Size, Model 2 Model 3 thru 6	2.0" x 2.0" x 0.5" 2.0" x 2.0" x 0.4"	2.0" x 2.0" x 0.5" 2.0" x 2.0" x 0.4"	2.0" x 2.0" x 0.5" 2.0" x 2.0" x 0.4"	
Range f_c	1.0 Hz to 102.4 kHz	1.0 Hz to 102.4 kHz	1.0 Hz to 102.4 kHz	
Theoretical Transfer Characteristics	Appendix A Page 27	Appendix A Page 31	Appendix A Page 33	
Passband Ripple (theoretical)	0.0 dB	0.20 dB	0.50 dB	
Voltage Gain (non-inverting)	0 ± 0.2 dB to 100 kHz 0 ± 0.5 dB to 120 kHz	0 ± 0.2 dB to 100 kHz 0 ± 0.5 dB to 120 kHz	0 ± 0.2 dB to 100 kHz 0 ± 0.5 dB to 120 kHz	
Power Bandwidth	120 kHz	120 kHz	120 kHz	
Small Signal Bandwidth	(-6 dB) 1 MHz	(-6 dB) 1 MHz	(-6 dB) 1 MHz	
Stopband Attenuation Rate	24 dB/octave	24 dB/octave	24 dB/octave	
Cutoff Frequency Stability Amplitude Phase	f_c ± 2% max. ± 0.01% /°C -3 dB -180°	f_c ± 2% max. ± 0.01% /°C -3 dB -231°	f_c ± 2% max. ± 0.01% /°C -3 dB -245°	
Filter Attenuation (theoretical)	40 dB 0.31 f_c 30 dB 0.42 f_c 3.01 dB 1.00 f_c 0.02 dB 2.00 f_c	40.0 dB 0.41 f_c 30.0 dB 0.53 f_c 3.01 dB 1.00 f_c -0.07 dB 2.00 f_c	40.0 dB 0.43 f_c 30.0 dB 0.56 f_c 3.01 dB 1.00 f_c -0.25 dB 2.00 f_c	
Phase Match¹	f_c - 100 kHz ± 3° max. ± 1.5° typ.	f_c - 100 kHz ± 3° max. ± 1.5° typ.	f_c - 100 kHz ± 3° max. ± 1.5° typ.	
Amplitude Accuracy (theoretical)	1.0 - 1.25 f_c ± 0.3 dB max. ± 0.15 dB typ. 1.25 f_c - 100 kHz ± 0.2 dB max. ± 0.1 dB typ.	1.00 - 1.25 f_c ± 0.3 dB max. ± 0.15 dB typ. 1.25 f_c - 100 kHz ± 0.2 dB max. ± 0.1 dB typ.	1.00 - 1.25 f_c ± 0.3 dB max. ± 0.15 dB typ. 1.25 f_c - 100 kHz ± 0.2 dB max. ± 0.1 dB typ.	
Total Harmonic Distortion @ 1 kHz	< - 100 dB typ.	< - 88 dB typ.	< - 88 dB typ.	
Wide Band Noise	400 μ Vrms typ.	400 μ Vrms typ.	400 μ Vrms typ.	
Narrow Band Noise (5 Hz - 100 kHz)	100 μ Vrms typ.	100 μ Vrms typ.	100 μ Vrms typ.	

1. Unit to unit match for the same transfer function, set to the same frequency and operating configuration, and from the same manufacturing lot.



D824 Series

Specification

(25°C and $V_s \pm 15$ Vdc)

Analog Input Characteristics¹

Impedance	10 k Ω min.
Voltage Range	± 10 Vpeak
Max. Safe Voltage	$\pm V_s$

Analog Output Characteristics

Impedance (Closed Loop)	1 Ω typ. 10 Ω max.
Linear Operating Range	± 10 V
Maximum Current ²	± 2 mA
Offset Voltage ³	2 mV typ. 20 mV max.
Offset Temp. Coeff.	50 μ V/ $^{\circ}$ C

Power Supply ($\pm V$)

Rated Voltage	± 15 Vdc
Operating Range	± 12 to ± 18 Vdc
Maximum Safe Voltage	± 18 Vdc
Quiescent Current	
4-Pole	± 13 mA typ. ± 20 mA max.

Temperature

Operating	0 to +70°C
Storage	-25 to +85°C

Notes:

- Input and output signal voltage referenced to supply common.
- Output is short circuit protected to common.
DO NOT CONNECT TO $\pm V_s$.
- Adjustable to zero.
- Units operate with or without offset pin connected.

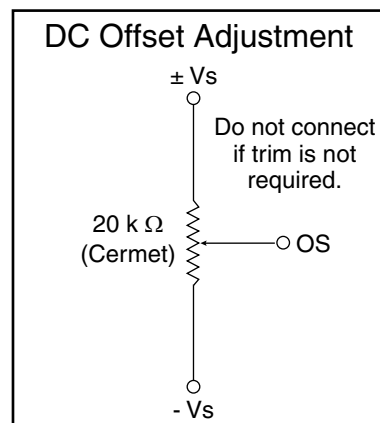

Pin-Out and Package Data Ordering Information

Pin-Out & Package Data

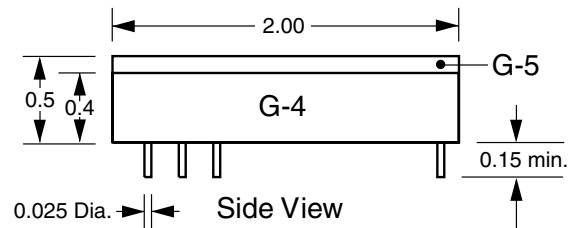

All dimensions are in inches
All Case Dimensions ± 0.02 "
Grid Dimensions 0.1" x 0.1"

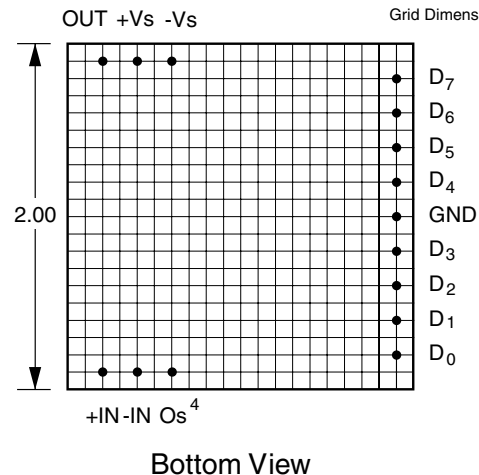

Filter Mounting Assembly-See FMA-02A

Ordering Information

Filter Type

L - Low Pass
H - High Pass

Transfer Function

B - Butterworth
L - Bessel
Y2 - Chebychev (0.2 dB Ripple)
Y5 - Chebychev (0.5 dB Ripple)

D824L8B-3

Model Number

e.g., Model Number	Tuning Range (Hz)	Minimum Step(Hz)	Case
2	1.0 to 256	1.0	G-5
3	10 to 2560	10	G-4
4	100 to 25.6k	100	G-4
5	200 to 51.2k	200	G-4
6	400 to 102.4k	400	G-4

We hope the information given here will be helpful. The information is based on data and our best knowledge, and we consider the information to be true and accurate. Please read all statements, recommendations or suggestions herein in conjunction with our conditions of sale which apply to all goods supplied by us. We assume no responsibility for the use of these statements, recommendations or suggestions, nor do we intend them as a recommendation for any use which would infringe any patent or copyright. **IN-00D824-00**



Programmable Filter Modules Power Sequence & ESD

November 2000

Programmable Filters Modules

818, 824, 828, 828BP, 828BR, 854, 858, R854, R858

I. Scope

The following precautions are necessary when handling and installing Frequency Devices programmable filter modules.

II. Digital Circuit Description

The digital input pins connect directly to 4000 series CMOS logic, such as the 4053 analog switch. The power supply (V_{ss}) for the digital logic on the module comes directly from the +15 Volt pin on the module. This sets the threshold voltage at 11.0 V minimum to 15.0 V maximum for a "1" (High) level and 0.0 V minimum to 4.0 V maximum for a "0" (Low) level. Applying a voltage between 4.0 and 11.0 V will produce unpredictable operation. Connecting 5 Volt or 3.3 V logic devices directly to the filter module without using a voltage translator will result in erratic operation of the filter.

III. (VERY IMPORTANT) Power-Up and Power-Down Sequence

Do not plug-in or un-plug module while power is applied. It is imperative that power is supplied to the + 15 V pin on the filter module before or at the same instance that any digital pin is pulled High (> 0.0 V). Failure to do this will result in excessive current flowing through the digital input pin and through a protection diode internal to the 4000 logic, which will result in damage to the module. The proper power-up and power-down sequence is:

1. Connect filter module ground.
2. Connect filter module +15 V.
3. Connect filter module -15 V.
4. Connect the input signal.

All four of the above steps can also occur simultaneously. Power-down should occur in the reverse order.

IV. ESD Issues

Like most modern electronic equipment, the modules can be damaged by electrostatic discharge (ESD). The modules are shipped from the factory in sealed, anti-static packaging and should be kept in the sealed package prior to mounting on a circuit board. The following additional rules should also be observed when handling the modules after they are removed from the factory packaging:

1. Only a person wearing a properly grounded wrist strap should handle the modules.
2. Any work surface that the modules are placed on must be properly ESD grounded.
3. Any insulating materials capable of generating static charge (such as paper) should be kept away from the modules.

Static generating clothing should be covered with an ESD-protective smock.



Appendix A

Theoretical Transfer Characteristics

f/fc (Hz)	Amp (dB)	Phase (deg)	Delay ¹ (sec)
0.00	0.00	0.00	.336
0.10	-0.028	-12.1	.336
0.20	-0.111	-24.2	.336
0.30	-0.251	-36.3	.336
0.40	-0.448	-48.4	.336
0.50	-0.705	-60.6	.336
0.60	-1.02	-72.7	.336
0.70	-1.41	-84.8	.336
0.80	-1.86	-96.8	.335
0.85	-2.11	-103	.334
0.90	-2.40	-109	.333
0.95	-2.69	-115	.332
1.00	-3.01	-121	.330
1.10	-3.71	-133	.325
1.20	-4.51	-144	.318
1.30	-5.39	-156	.308
1.40	-6.37	-166	.295
1.50	-7.42	-177	.280
1.60	-8.54	-187	.263
1.70	-9.71	-195	.246
1.80	-10.9	-204	.228
1.90	-12.2	-212	.211
2.00	-13.4	-219	.194
2.25	-16.5	-235	.158
2.50	-19.5	-248	.129
2.75	-22.4	-259	.107
3.00	-25.1	-267	.089
3.25	-27.6	-275	.076
3.50	-30.0	-281	.065
4.00	-34.4	-291	.049
5.00	-41.9	-305	.031
6.00	-48.1	-315	.021
7.00	-53.4	-321	.016
8.00	-58.0	-326	.012
9.00	-62.0	-330	.009
10.0	-65.7	-333	.008

Frequency Response

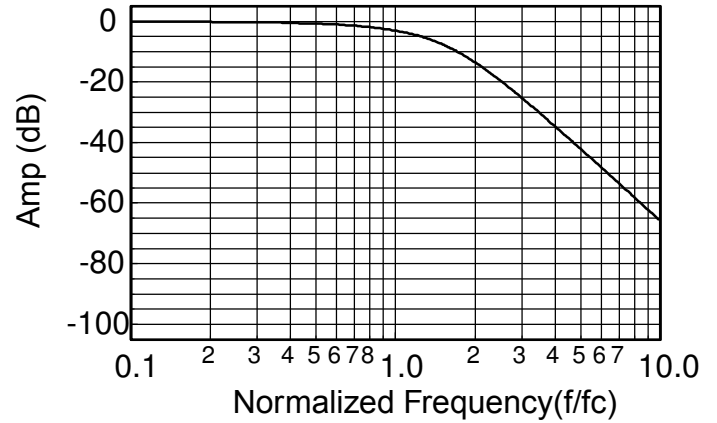

Delay (Normalized)

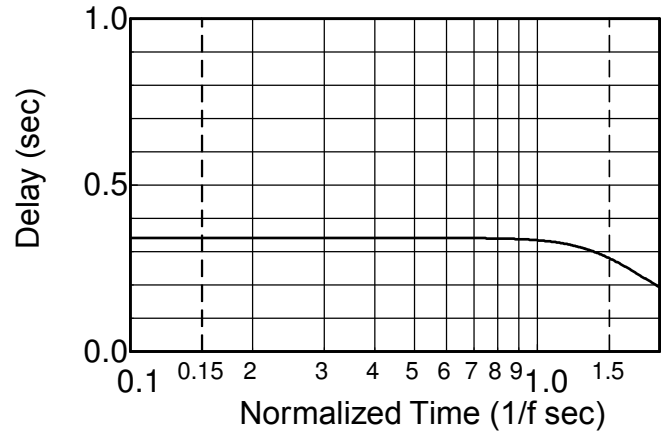

Step Response

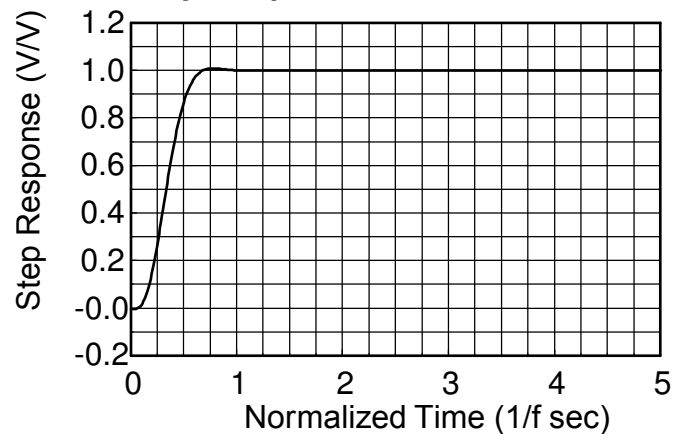

1. Normalized Group Delay:

The above delay data is normalized to a corner frequency of 1.0Hz. The actual delay is the normalized delay divided by the actual corner frequency (fc).

$$\text{Actual Delay} = \frac{\text{Normalized Delay}}{\text{Actual Corner Frequency (fc) in Hz}}$$



Appendix A

Theoretical Transfer Characteristics

f/fc (Hz)	Amp (dB)	Phase (deg)	Delay ¹ (sec)
0.00	0.00	0.00	.416
0.10	0.00	-15.0	.418
0.20	0.00	-30.1	.423
0.30	-0.00	-45.5	.433
0.40	-0.003	-61.4	.449
0.50	-0.017	-78.0	.474
0.60	-0.072	-95.7	.511
0.70	-0.243	-115	.558
0.80	-0.674	-136	.604
0.85	-1.047	-147	.619
0.90	-1.555	-158	.622
0.95	-2.21	-169	.612
1.00	-3.01	-180	.588
1.10	-4.97	-200	.513
1.20	-7.24	-217	.427
1.30	-9.62	-231	.350
1.40	-12.0	-242	.289
1.50	-14.3	-252	.241
1.60	-16.4	-260	.204
1.70	-18.5	-266	.175
1.80	-20.5	-272	.152
1.90	-22.3	-277	.134
2.00	-24.1	-282	.119
2.25	-28.2	-291	.091
2.50	-31.8	-299	.072
2.75	-35.1	-304	.059
3.00	-38.2	-309	.049
3.25	-41.0	-313	.041
3.50	-43.5	-317	.035
4.00	-48.2	-322	.027
5.00	-55.9	-330	.017
6.00	-62.3	-335	.012
7.00	-67.6	-339	.009
8.00	-72.2	-341	.007
9.00	-76.3	-343	.005
10.0	-80.0	-345	.004

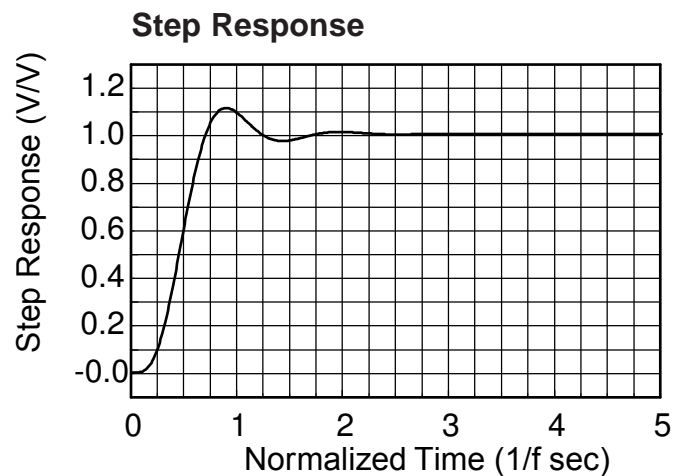
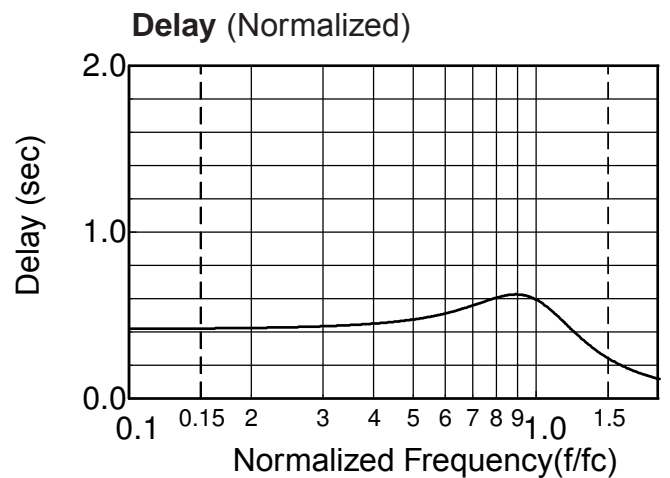
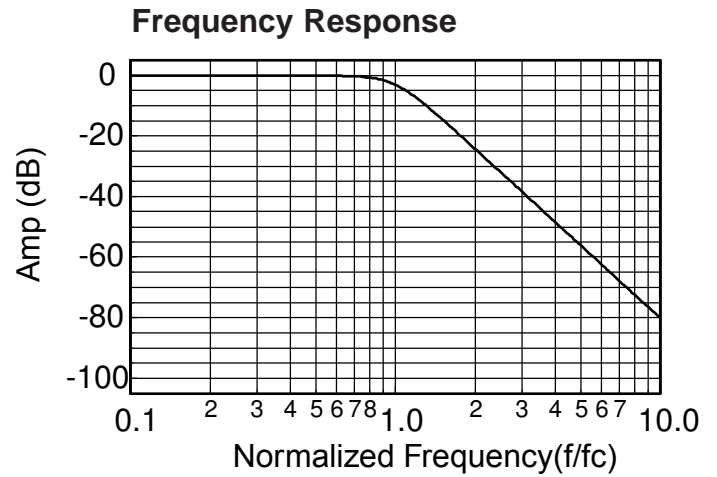

1. Normalized Group Delay:

The above delay data is normalized to a corner frequency of 1.0Hz. The actual delay is the normalized delay divided by the actual corner frequency (fc).

$$\text{Actual Delay} = \frac{\text{Normalized Delay}}{\text{Actual Corner Frequency (fc) in Hz}}$$



Appendix A

Theoretical Transfer Characteristics

f/fc (Hz)	Amp (dB)	Phase (deg)	Delay ¹ (sec)
0.00	0.000	0.00	.478
0.10	0.039	-17.3	.487
0.20	0.129	-35.2	.509
0.30	0.195	-54.0	.533
0.40	0.174	-73.4	.547
0.50	0.074	-93.2	.553
0.60	0.000	-113	.575
0.70	0.074	-135	.654
0.80	0.199	-162	.836
0.85	0.063	-178	.947
0.90	-0.443	-196	1.02
0.95	-1.47	-214	.989
1.00	-3.01	-231	.873
1.10	-6.89	-257	.583
1.20	-10.8	-274	.385
1.30	-14.5	-286	.271
1.40	-17.7	-294	.202
1.50	-20.7	-300	.158
1.60	-23.4	-306	.128
1.70	-25.8	-310	.107
1.80	-28.1	-313	.090
1.90	-30.2	-316	.078
2.00	-32.2	-319	.068
2.25	-36.7	-324	.051
2.50	-40.6	-328	.039
2.75	-44.1	-331	.032
3.00	-47.3	-334	.026
3.25	-50.2	-336	.022
3.50	-52.8	-338	.018
4.00	-57.6	-341	.014
5.00	-65.5	-345	.009
6.00	-71.9	-347	.006
7.00	-77.3	-349	.004
8.00	-82.0	-351	.003
9.00	-86.1	-352	.003
10.0	-89.8	-352	.002

Frequency Response

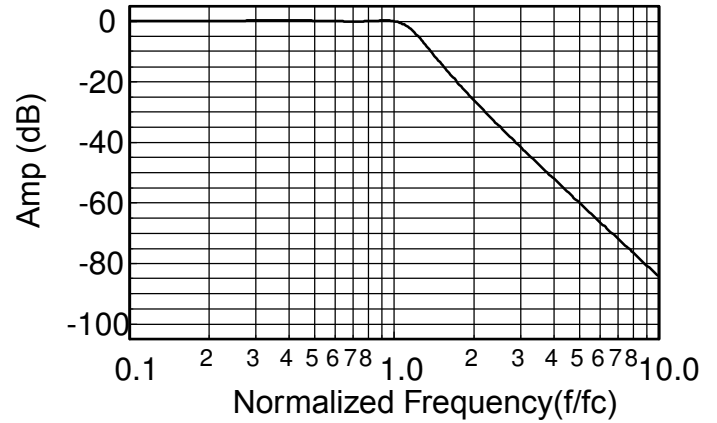

Delay (Normalized)

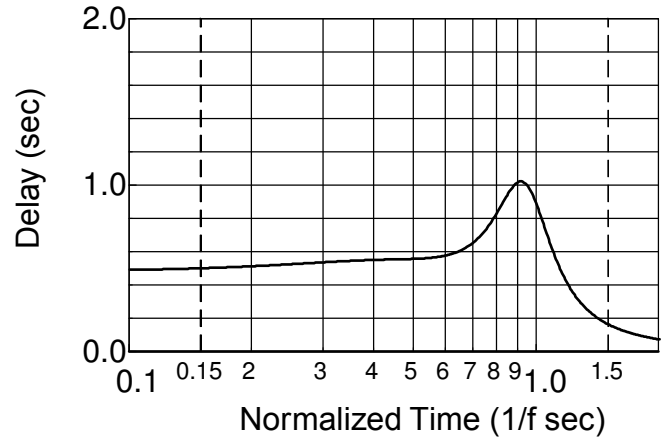

Step Response

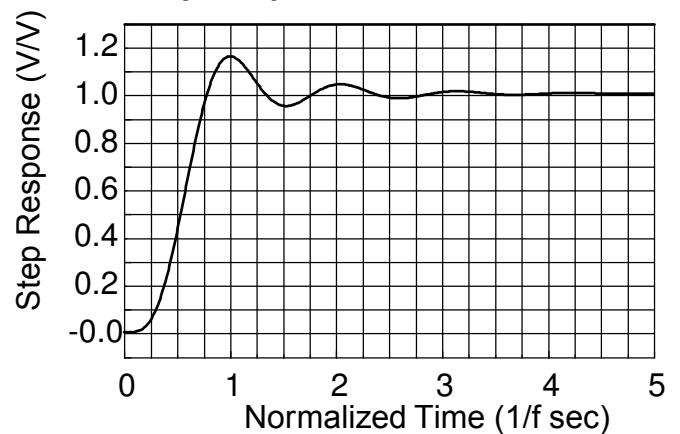

1. Normalized Group Delay:

The above delay data is normalized to a corner frequency of 1.0Hz. The actual delay is the normalized delay divided by the actual corner frequency (fc).

$$\text{Actual Delay} = \frac{\text{Normalized Delay}}{\text{Actual Corner Frequency (fc) in Hz}}$$



Appendix A

Theoretical Transfer Characteristics

f/fc (Hz)	Amp (dB)	Phase (deg)	Delay ¹ (sec)
0.00	0.00	0.00	.476
0.10	0.087	-17.3	.492
0.20	0.295	-35.7	.533
0.30	0.474	-55.7	.577
0.40	0.463	-76.9	.596
0.50	0.248	-98.2	.583
0.60	0.025	-119	.578
0.70	0.072	-141	.647
0.80	0.432	-168	.881
0.85	0.482	-185	1.06
0.90	0.062	-205	1.18
0.95	-1.12	-226	1.13
1.00	-3.01	-245	.946
1.10	-7.61	-272	.559
1.20	-12.0	-288	.345
1.30	-15.9	-298	.235
1.40	-19.3	-305	.173
1.50	-22.4	-311	.134
1.60	-25.1	-315	.108
1.70	-27.6	-318	.089
1.80	-29.9	-321	.075
1.90	-32.1	-324	.065
2.00	-34.1	-326	.057
2.25	-38.6	-301	.042
2.50	-42.6	-334	.033
2.75	-46.1	-336	.026
3.00	-49.3	-339	.021
3.25	-52.2	-340	.018
3.50	-54.9	-342	.015
4.00	-59.7	-344	.011
5.00	-67.6	-347	.007
6.00	-74.0	-350	.005
7.00	-79.4	-351	.004
8.00	-84.1	-352	.003
9.00	-88.2	-353	.002
10.0	-91.9	-354	.002

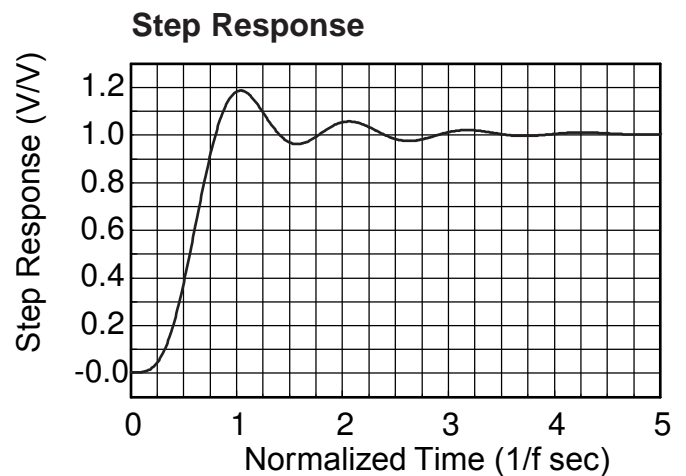
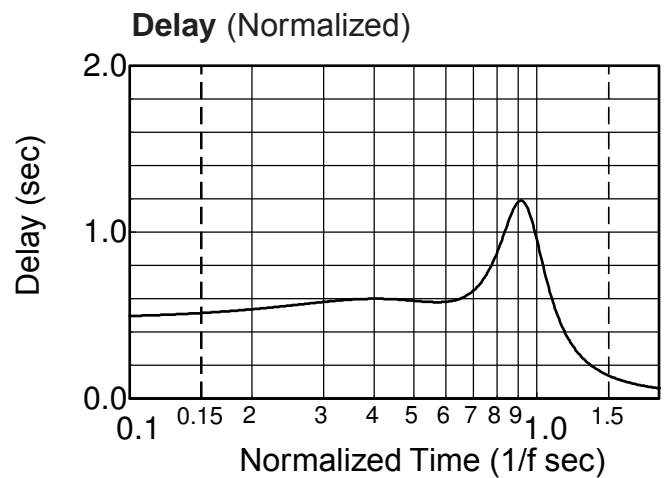
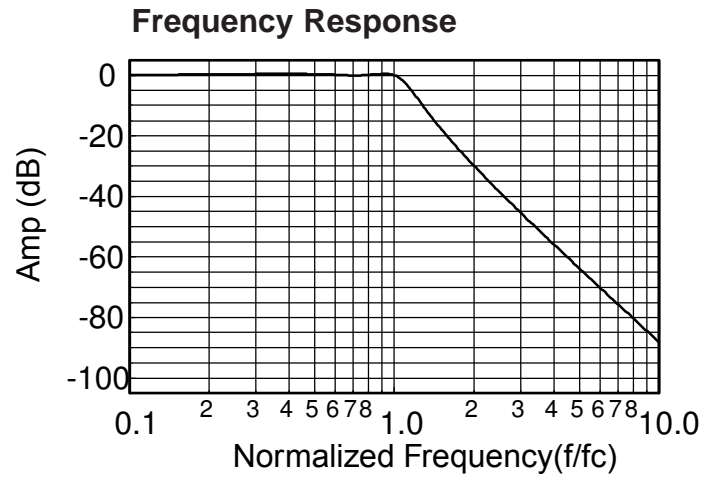

1. Normalized Group Delay:

The above delay data is normalized to a corner frequency of 1.0Hz. The actual delay is the normalized delay divided by the actual corner frequency (fc).

$$\text{Actual Delay} = \frac{\text{Normalized Delay}}{\text{Actual Corner Frequency (fc) in Hz}}$$



Appendix A

Theoretical Transfer Characteristics

f/fc (Hz)	Amp (dB)	Phase (deg)	Delay ¹ (sec)
0.10	-80.0	345	.418
0.20	-55.9	330	.423
0.30	-41.8	314	.433
0.40	-31.8	299	.449
0.50	-24.1	282	.474
0.60	-17.8	264	.511
0.70	-12.6	245	.558
0.80	-8.43	224	.604
0.85	-6.69	213	.619
0.90	-5.22	202	.622
0.95	-3.99	191	.612
1.00	-3.01	180	.588
1.20	-0.908	143	.427
1.40	-0.285	118	.289
1.60	-0.100	100	.204
1.80	-0.039	87.6	.152
2.00	-0.017	78.0	.119
2.50	-0.003	61.4	.072
3.00	-0.001	50.7	.049
4.00	0.00	37.8	.027
5.00	0.00	30.1	.017
6.00	0.00	25.1	.012
7.00	0.00	21.4	.009
8.00	0.00	18.8	.007
9.00	0.00	16.7	.005
10.0	0.00	15.0	.004

Frequency Response

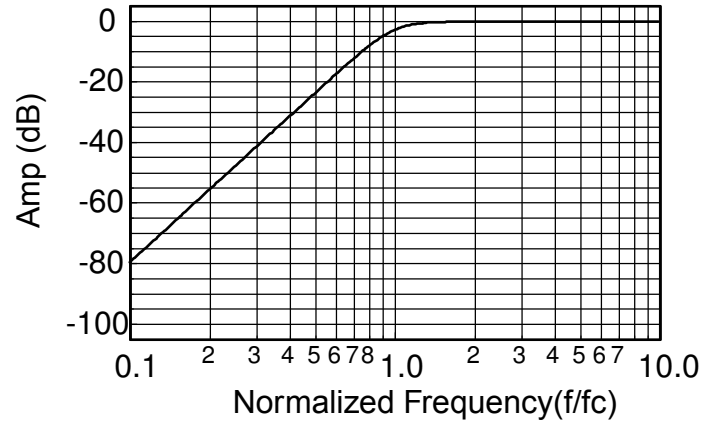

1. Normalized Group Delay:

The above delay data is normalized to a corner frequency of 1.0Hz. The actual delay is the normalized delay divided by the actual corner frequency (fc).

$$\text{Actual Delay} = \frac{\text{Normalized Delay}}{\text{Actual Corner Frequency (fc) in Hz}}$$



Appendix A

Theoretical Transfer Characteristics

f/fc (Hz)	Amp (dB)	Phase (deg)	Delay¹ (sec)
0.10	-89.8	352	.212
0.20	-65.1	345	.218
0.30	-51.1	337	.228
0.40	-40.6	328	.245
0.50	-32.2	319	.272
0.60	-25.0	308	.314
0.70	-18.6	296	.383
0.80	-12.7	280	.500
0.90	-7.34	259	.686
1.00	-3.01	231	.873
1.20	.140	172	.633
1.50	.031	128	.275
1.70	.003	111	.197
2.00	.074	93.2	.138
2.50	.174	73.4	.088
3.00	.200	60.4	.060
4.00	.170	44.5	.033
5.00	.129	35.2	.020
6.00	.098	29.2	.014
7.00	.076	24.9	.010
8.00	.060	21.7	.008
9.00	.048	19.3	.006
10.0	.040	17.3	.005

Frequency Response

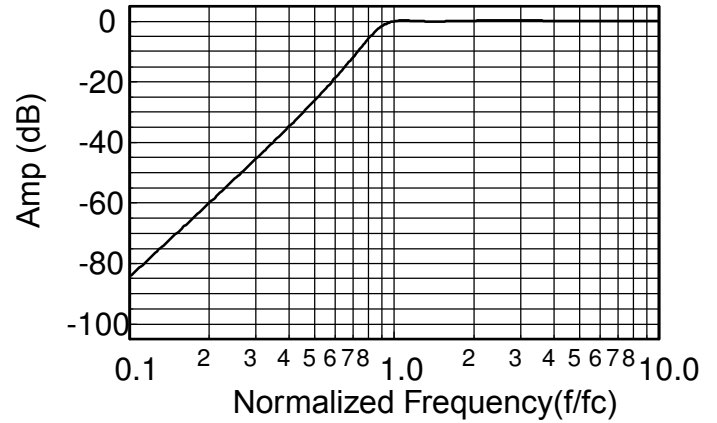

1. Normalized Group Delay:

The above delay data is normalized to a corner frequency of 1.0Hz. The actual delay is the normalized delay divided by the actual corner frequency (fc).

$$\text{Actual Delay} = \frac{\text{Normalized Delay}}{\text{Actual Corner Frequency (fc) in Hz}}$$



Appendix A

Theoretical Transfer Characteristics

f/fc (Hz)	Amp (dB)	Phase (deg)	Delay¹ (sec)
0.10	-91.9	354	.174
0.20	-67.6	347	.179
0.30	-53.1	341	.188
0.40	-42.6	334	.203
0.50	-34.1	326	.226
0.60	-26.8	317	.263
0.70	-20.2	307	.326
0.80	-14.0	293	.440
0.90	-8.13	274	.651
1.00	-3.01	245	.946
1.20	.500	179	.693
1.50	.014	133	.271
1.70	.043	117	.199
2.00	.249	98.2	.146
2.50	.469	76.9	.095
3.00	.498	62.7	.065
4.00	.401	45.5	.035
5.00	.296	35.7	.021
6.00	.221	29.4	.014
7.00	.169	25.0	.010
8.00	.133	21.8	.008
9.00	.107	19.3	.006
10.0	.088	17.3	.005

Frequency Response

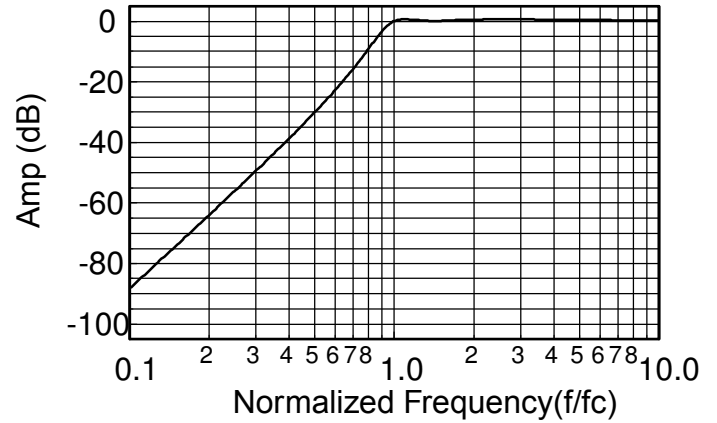

1. Normalized Group Delay:

The above delay data is normalized to a corner frequency of 1.0Hz. The actual delay is the normalized delay divided by the actual corner frequency (fc).

$$\text{Actual Delay} = \frac{\text{Normalized Delay}}{\text{Actual Corner Frequency (fc) in Hz}}$$