



1.0 Hz to 100 kHz  
Fixed Frequency

32-Pin DIP  
4 - Pole Filters

## Description

The D64 and DP64 Series of small 4-pole fixed-frequency, precision active filters provide high performance linear active filtering in a compact 32-pin DIP package, with a broad range of corner frequencies and a choice of transfer functions. Individual D64 filters can serve in low-pass or high-pass applications (DP64, low-pass only) or be combined to create custom band-pass or band-reject filters. These fully self-contained units require no external components or adjustments. Each model comes factory tuned to a user-specified corner frequency between 1 Hz and 100 kHz (DP64, 1 Hz to 5 kHz) and operate with low total harmonic distortion over a wide dynamic input voltage range from non-critical +/-5V to +/-18V power supplies.

## Features/Benefits:

- Low harmonic distortion and wide signal-to-noise ratio
- Compact 1.8"L x 0.8"W x 0.3"H minimizes board space requirements.
- Plug-in ready-to-use, reducing engineering design and manufacturing cycle time.
- Factory tuned, no external clocks or adjustments needed
- Broad range of transfer characteristics and corner frequencies to meet a wide range of applications.

## Applications

- Anti-alias filtering
- Data acquisition systems
- Communication systems and electronics
- Medical electronics equipment and research
- Aerospace, navigation and sonar applications
- Sound and vibration testing
- Acoustic and vibration analysis and control
- Noise elimination
- Signal reconstruction



Available Low-Pass Models:		Page
<b>D64L4B &amp; DP64L4B</b>	4-pole Butterworth	.....2
<b>D64L4L &amp; DP64L4L</b>	4-pole Bessel	.....2
<b>D64L4Y2 &amp; DP64L4Y2</b>	4-pole Cheby (0.2 dB Ripple)	.....2
<b>D64L4Y5 &amp; DP64L4Y5</b>	4-pole Cheby (0.5 dB Ripple)	.....2

Available High-Pass Models:		
<b>D64H4B</b>	4-pole Butterworth	.....3
<b>D64H4Y2</b>	4-pole Cheby (0.2 dB Ripple)	.....3
<b>D64H4Y5</b>	4-pole Cheby (0.5 dB Ripple)	.....3

## General Specifications:

Pin-out/package data & ordering information . . . .4



## Fixed Frequency

## 4-Pole Low-Pass Filters

Model	D64L4B & DP64L4B	D64L4L & DP64L4L	D64L4Y2 & DP64L4Y2	D64L4Y5 & DP64L4Y5
<b>Product Specifications</b>				
<b>Transfer Function</b>	4-Pole, Butterworth	4-Pole, Bessel	4-Pole, Chebychev,	4-Pole, Chebychev, 0.5 dB Ripple
<b>Size</b>	1.8" x 0.8" x 0.3"	1.8" x 0.8" x 0.3"	1.8" x 0.8" x 0.3"	1.8" x 0.8" x 0.3"
<b>Range f<sub>c</sub></b> <b>D64</b> <b>DP64</b>	1 Hz to 100 kHz 1 Hz to 5 kHz	1 Hz to 100 kHz 1 Hz to 5 kHz	1 Hz to 100 kHz 1 Hz to 5 kHz	1 Hz to 100 kHz 1 Hz to 5 kHz
<b>Theoretical Transfer Characteristics</b>	Appendix A Page 7	Appendix A Page 2	Appendix A Page 12	Appendix A Page 15
<b>Passband Ripple</b> (theoretical)	0.0 dB	0.0 dB	0.20 dB	0.50 dB
<b>DC Voltage Gain</b> (non-inverting)	0 ± 0.1 dB max. 0 ± 0.05 dB typ.	0 ± 0.1 dB max. 0 ± 0.05 dB typ.	0 ± 0.1 dB max. 0 ± 0.05 dB typ.	0 ± 0.1 dB max. 0 ± 0.05 dB typ.
<b>Stopband Attenuation Rate</b>	24 dB/octave	24 dB/octave	24 dB/octave	24 dB/octave
<b>Cutoff Frequency Stability</b> <b>Amplitude</b> <b>Phase</b>	f <sub>c</sub> ± 1% max. ± 0.01% /°C -3dB -180°	f <sub>c</sub> ± 1% max. ± 0.01% /°C -3dB -121°	f <sub>c</sub> ± 1% max. ± 0.01% /°C -3dB -231°	f <sub>c</sub> ± 1% max. ± 0.01% /°C -3dB -245°
<b>Filter Attenuation</b> (theoretical)	0.67 dB      0.80 f <sub>c</sub> 3.01 dB      1.00 f <sub>c</sub> 30.0 dB      2.37 f <sub>c</sub> 40.0 dB      3.16 f <sub>c</sub>	1.86 dB      0.80 f <sub>c</sub> 3.01 dB      1.00 f <sub>c</sub> 30.0 dB      3.50 f <sub>c</sub> 40.0 dB      4.72 f <sub>c</sub>	-0.20 dB      0.80 f <sub>c</sub> 3.01 dB      1.00 f <sub>c</sub> 30.0 dB      1.89 f <sub>c</sub> 40.0 dB      2.46 f <sub>c</sub>	-0.43 dB      0.80 f <sub>c</sub> 3.01 dB      1.00 f <sub>c</sub> 30.0 dB      1.80 f <sub>c</sub> 40.0 dB      2.33 f <sub>c</sub>
<b>Phase Match<sup>1</sup></b>	0 - 0.8 f <sub>c</sub> ± 2° max. ± 1° typ. 0.8 f <sub>c</sub> - 1.0 f <sub>c</sub> ± 3° max. ± 1.5° typ.	0 - f <sub>c</sub> ± 2° max. ± 1° typ.	0 - 0.8 f <sub>c</sub> ± 2° max. ± 1° typ. 0.8 f <sub>c</sub> - 1.0 f <sub>c</sub> ± 3° max. ± 1.5° typ.	0 - 0.8 f <sub>c</sub> ± 2° max. ± 1° typ. 0.8 f <sub>c</sub> - 1.0 f <sub>c</sub> ± 3° max. ± 1.5° typ.
<b>Amplitude Accuracy</b> (theoretical)	0 - 0.8 f <sub>c</sub> ± 0.2 dB max. ± 0.1 dB typ. 0.8 f <sub>c</sub> - 1.0 f <sub>c</sub> ± 0.3 dB max. ± 0.15 dB typ.	0 - f <sub>c</sub> ± 0.2 dB max. ± 0.1 dB typ.	0 - 0.8 f <sub>c</sub> ± 0.2 dB max. ± 0.1 dB typ. 0.8 f <sub>c</sub> - 1.0 f <sub>c</sub> ± 0.3 dB max. ± 0.15 dB typ.	0 - 0.8 f <sub>c</sub> ± 0.2 dB max. ± 0.1 dB typ. 0.8 - 1.0 f <sub>c</sub> ± 0.3 dB max. ± 0.15 dB typ.
<b>Total Harmonic Distortion @ 1 kHz</b> <b>D64</b> <b>DP64</b>	<-100 dB <-80 dB	<-100 dB <-80 dB	<-88 dB <-80 dB	<-88 dB <-80 dB
<b>Wide Band Noise</b> (5 Hz - 2 MHz)	200 μVrms typ.	200 μVrms typ.	200 μVrms typ.	200 μVrms typ.
<b>Narrow Band Noise</b> (20 Hz - 100 kHz)	50 μVrms typ.	50 μVrms typ.	50 μVrms typ.	50 μVrms typ.
<b>Filter Mounting Assembly</b>	FMA-01S	FMA-01S	FMA-01S	FMA-01S

1. Unit to unit match for the same transfer function, set to the same frequency and operating configuration, and from the same manufacturing lot.



## Fixed Frequency

## 4-Pole High-Pass Filters

Model	D64H4B	64H4Y2	D64H4Y5
<b>Product Specifications</b>			
<b>Transfer Function</b>	4-Pole, Butterworth	4-Pole, Chebychev, 0.2 dB Ripple	4-Pole, Chebychev, 0.5 dB Ripple
<b>Size</b>	1.8" x 0.8" x 0.3"	1.8" x 0.8" x 0.3"	1.8" x 0.8" x 0.3"
<b>Range <math>f_c</math></b> <b>D64</b> <b>DP64</b>	1 Hz to 100 kHz Not Available	1 Hz to 100 kHz Not Available	1 Hz to 100 kHz Not Available
<b>Theoretical Transfer Characteristics</b>	Appendix A Page 27	Appendix A Page 31	Appendix A Page 33
<b>Passband Ripple</b> (theoretical)	0.0 dB	0.20 dB	0.50 dB
<b>Voltage Gain</b> (non-inverting)	0 ± 0.2 dB to 100 kHz 0 ± 0.5 dB to 120 kHz	0 ± 0.2 dB to 100 kHz 0 ± 0.5 dB to 120 kHz	0 ± 0.2 dB to 100 kHz 0 ± 0.5 dB to 120 kHz
<b>Power Bandwidth</b>	120 kHz	120 kHz	120 kHz
<b>Small Signal Bandwidth</b>	(-6dB) 1 MHz	(-6dB) 1 MHz	(-6dB) 1 MHz
<b>Stopband Attenuation Rate</b>	24 dB/octave	24 dB/octave	24 dB/octave
<b>Cutoff Frequency Stability</b> <b>Amplitude</b> <b>Phase</b>	$f_c$ ± 1% max. ± 0.01% /°C -3dB -180°	$f_c$ ± 1% max. ± 0.01% /°C -3dB -231°	$f_c$ ± 1% max. ± 0.01% /°C -3dB -245°
<b>Filter Attenuation</b> (theoretical)	40 dB      0.31 $f_c$ 30 dB      0.42 $f_c$ 3.01 dB    1.00 $f_c$ 0.02 dB    2.00 $f_c$	40 dB      0.41 $f_c$ 30 dB      0.53 $f_c$ 3.01 dB    1.00 $f_c$ -0.07 dB   2.00 $f_c$	40 dB      0.43 $f_c$ 30 dB      0.56 $f_c$ 3.01 dB    1.00 $f_c$ -0.25 dB   2.00 $f_c$
<b>Phase Match<sup>1</sup></b>	$f_c$ - 100 kHz    ± 3° max. ± 1.5° typ.	$f_c$ - 100 kHz    ± 3° max. ± 1.5° typ.	$f_c$ - 100 kHz    ± 3° max. ± 1.5° typ.
<b>Amplitude Accuracy</b> (theoretical)	1.0 - 1.25 $f_c$ ± 0.30 dB max. ± 0.15 dB typ. 1.25 $f_c$ - 100 kHz ± 0.20 dB max. ± 0.10 dB typ.	1.0 - 1.25 $f_c$ ± 0.30 dB max. ± 0.15 dB typ. 1.25 $f_c$ - 100 kHz ± 0.20 dB max. ± 0.10 dB typ.	1.0 - 1.25 $f_c$ ± 0.30 dB max. ± 0.15 dB typ. 1.25 $f_c$ - 100 kHz ± 0.20 dB max. ± 0.10 dB typ.
<b>Total Harmonic Distortion @ 1 kHz</b> <b>D64</b>	<-88 dB	<-88dB	<-88 dB
<b>Wide Band Noise</b> (5 Hz - 2 MHz)	400 $\mu$ Vrms typ.	400 $\mu$ Vrms typ.	400 $\mu$ Vrms typ.
<b>Narrow Band Noise</b> (20 Hz - 100 kHz)	100 $\mu$ Vrms typ.	100 $\mu$ Vrms typ.	100 $\mu$ Vrms typ.
<b>Filter Mounting Assembly</b>	FMA-01S	FMA-01S	FMA-01S

1. Unit to unit match for the same transfer function, set to the same frequency and operating configuration, and from the same manufacturing lot.



## Specification

(25°C and  $V_s \pm 15$  Vdc)

## Pin-Out and Package Data Ordering Information

### Analog Input Characteristics<sup>1</sup>

Impedance	10 k $\Omega$ min.
Voltage Range	$\pm 10$ Vpeak
Max. Safe Voltage	$\pm V_s$

### Analog Output Characteristics

Impedance(Closed Loop)	1 $\Omega$ typ. 10 $\Omega$ max.
Linear Operating Range	$\pm 10$ V
Maximum Current <sup>2</sup>	$\pm 2$ mA
Offset Voltage <sup>3</sup>	2 mV typ. 10 mV max.
Offset Temp. Coeff.	50 $\mu$ V / °C

### Power Supply ( $\pm V$ )

Rated Voltage	$\pm 15$ Vdc
Operating Range	$\pm 5$ to $\pm 18$ Vdc
Maximum Safe Voltage	$\pm 18$ Vdc
Quiescent Current D64	$\pm 12.5$ mA typ. $\pm 20$ mA max.
DP64	$\pm 3.5$ mA typ. $\pm 5$ mA max.

### Temperature

Operating	0 to + 70 °C
Storage	- 25 to + 85 °C

#### Notes:

- Input and output signal voltage referenced to supply common.
- Output is short circuit protected to common.  
DO NOT CONNECT TO  $\pm V_s$ .
- Adjustable to zero.

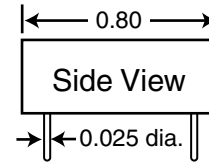
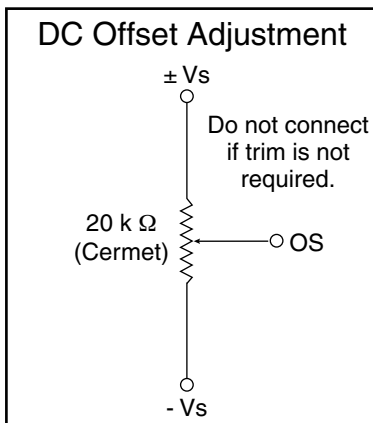

All dimensions are in inches  
All case dimensions  $\pm 0.01$ "

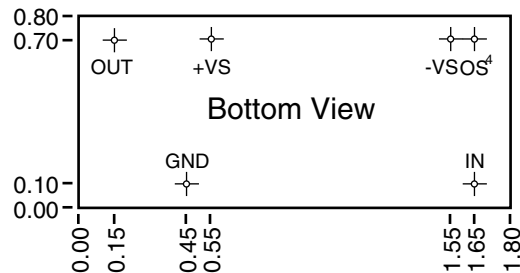
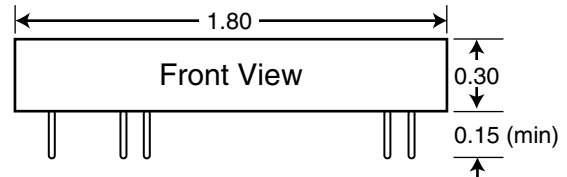

Filter Mounting Assembly-See FMA-01A

## Ordering Information

### Filter Type

- L - Low Pass
- H - High Pass

### Transfer Function

- B - Butterworth
- L - Bessel
- Y2 - 0.2 Ripple Chebychev
- Y5 - 0.5 Ripple Chebychev

## D64L4B-849 Hz

### Power Level

- D - Standard Power
- DP - Low Power

### - 3 dB Corner Frequency<sup>5</sup>

- e.g., 849 Hz
- 2.50 kHz
- 33.3 kHz

4. Units operate with or with out offset pin connected.

5. How to Specify Corner Frequency:

Corner frequencies are specified by attaching a three digit frequency designator to the basic model number. Corner frequencies can range from 1.00 Hz to 100 kHz.



**Appendix A**

**Theoretical Transfer Characteristics**

f/fc (Hz)	Amp (dB)	Phase (deg)	Delay <sup>1</sup> (sec)
0.00	0.00	0.00	.336
0.10	-0.028	-12.1	.336
0.20	-0.111	-24.2	.336
0.30	-0.251	-36.3	.336
0.40	-0.448	-48.4	.336
0.50	-0.705	-60.6	.336
0.60	-1.02	-72.7	.336
0.70	-1.41	-84.8	.336
0.80	-1.86	-96.8	.335
0.85	-2.11	-103	.334
0.90	-2.40	-109	.333
0.95	-2.69	-115	.332
1.00	-3.01	-121	.330
1.10	-3.71	-133	.325
1.20	-4.51	-144	.318
1.30	-5.39	-156	.308
1.40	-6.37	-166	.295
1.50	-7.42	-177	.280
1.60	-8.54	-187	.263
1.70	-9.71	-195	.246
1.80	-10.9	-204	.228
1.90	-12.2	-212	.211
2.00	-13.4	-219	.194
2.25	-16.5	-235	.158
2.50	-19.5	-248	.129
2.75	-22.4	-259	.107
3.00	-25.1	-267	.089
3.25	-27.6	-275	.076
3.50	-30.0	-281	.065
4.00	-34.4	-291	.049
5.00	-41.9	-305	.031
6.00	-48.1	-315	.021
7.00	-53.4	-321	.016
8.00	-58.0	-326	.012
9.00	-62.0	-330	.009
10.0	-65.7	-333	.008

**Frequency Response**

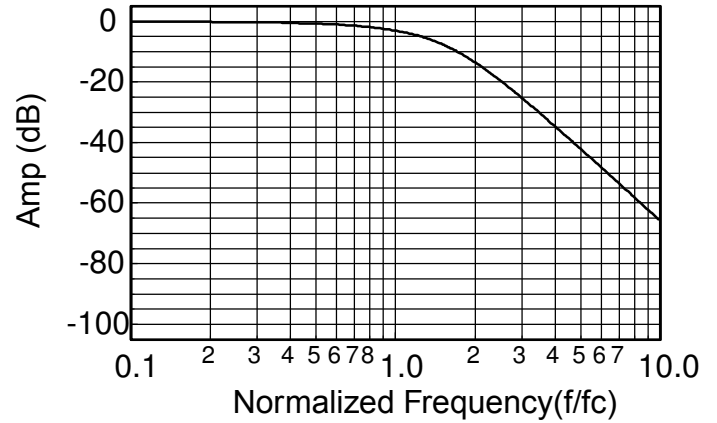

**Delay (Normalized)**

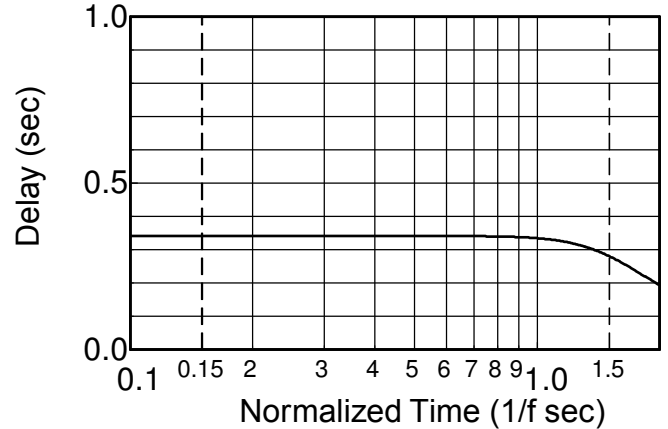

**Step Response**

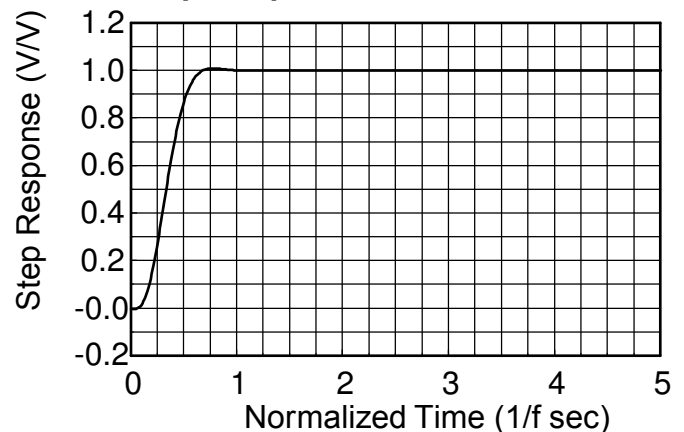

**1. Normalized Group Delay:**

The above delay data is normalized to a corner frequency of 1.0Hz. The actual delay is the normalized delay divided by the actual corner frequency (fc).

$$\text{Actual Delay} = \frac{\text{Normalized Delay}}{\text{Actual Corner Frequency (fc) in Hz}}$$



**Appendix A**

**Theoretical Transfer Characteristics**

f/fc (Hz)	Amp (dB)	Phase (deg)	Delay <sup>1</sup> (sec)
0.00	0.00	0.00	.416
0.10	0.00	-15.0	.418
0.20	0.00	-30.1	.423
0.30	-0.00	-45.5	.433
0.40	-0.003	-61.4	.449
0.50	-0.017	-78.0	.474
0.60	-0.072	-95.7	.511
0.70	-0.243	-115	.558
0.80	-0.674	-136	.604
0.85	-1.047	-147	.619
0.90	-1.555	-158	.622
0.95	-2.21	-169	.612
1.00	-3.01	-180	.588
1.10	-4.97	-200	.513
1.20	-7.24	-217	.427
1.30	-9.62	-231	.350
1.40	-12.0	-242	.289
1.50	-14.3	-252	.241
1.60	-16.4	-260	.204
1.70	-18.5	-266	.175
1.80	-20.5	-272	.152
1.90	-22.3	-277	.134
2.00	-24.1	-282	.119
2.25	-28.2	-291	.091
2.50	-31.8	-299	.072
2.75	-35.1	-304	.059
3.00	-38.2	-309	.049
3.25	-41.0	-313	.041
3.50	-43.5	-317	.035
4.00	-48.2	-322	.027
5.00	-55.9	-330	.017
6.00	-62.3	-335	.012
7.00	-67.6	-339	.009
8.00	-72.2	-341	.007
9.00	-76.3	-343	.005
10.0	-80.0	-345	.004

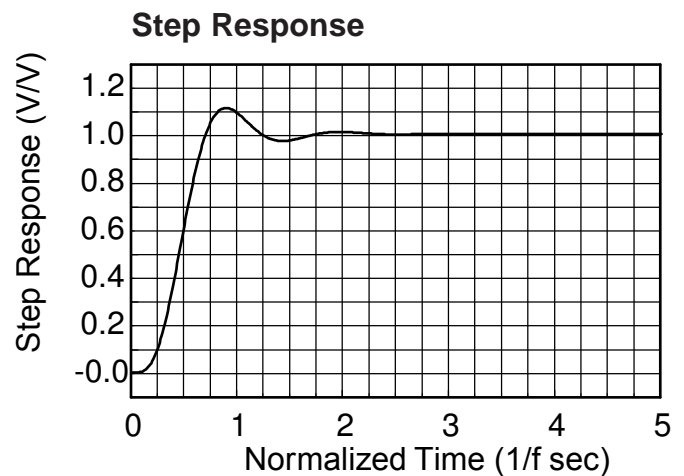
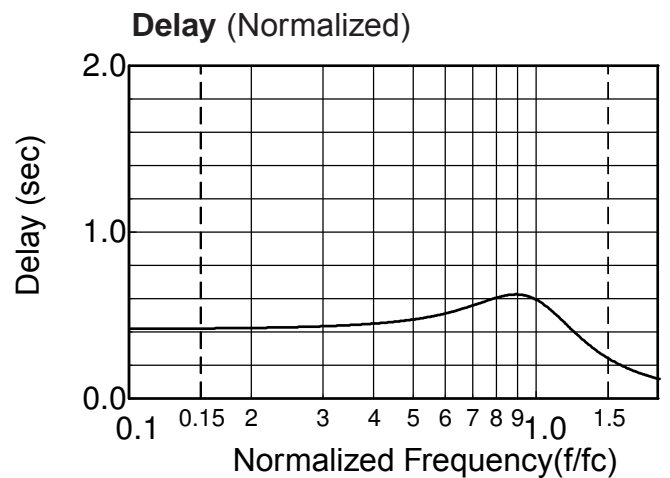
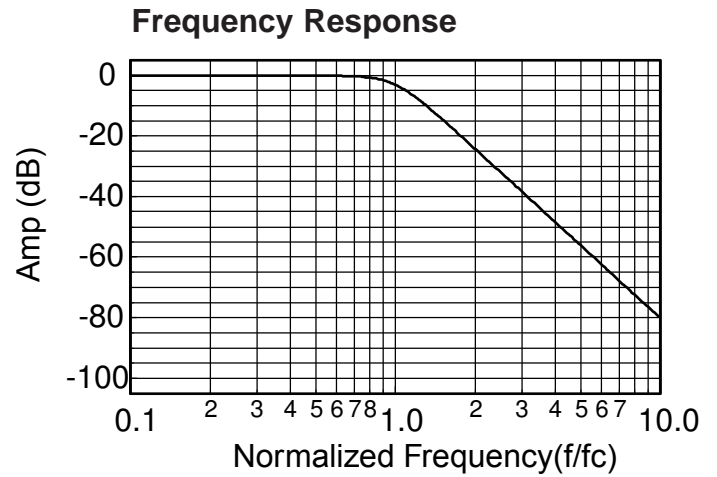

**1. Normalized Group Delay:**

The above delay data is normalized to a corner frequency of 1.0Hz. The actual delay is the normalized delay divided by the actual corner frequency (fc).

$$\text{Actual Delay} = \frac{\text{Normalized Delay}}{\text{Actual Corner Frequency (fc) in Hz}}$$



**Appendix A**

**Theoretical Transfer Characteristics**

f/fc (Hz)	Amp (dB)	Phase (deg)	Delay <sup>1</sup> (sec)
0.00	0.000	0.00	.478
0.10	0.039	-17.3	.487
0.20	0.129	-35.2	.509
0.30	0.195	-54.0	.533
0.40	0.174	-73.4	.547
0.50	0.074	-93.2	.553
0.60	0.000	-113	.575
0.70	0.074	-135	.654
0.80	0.199	-162	.836
0.85	0.063	-178	.947
0.90	-0.443	-196	1.02
0.95	-1.47	-214	.989
1.00	-3.01	-231	.873
1.10	-6.89	-257	.583
1.20	-10.8	-274	.385
1.30	-14.5	-286	.271
1.40	-17.7	-294	.202
1.50	-20.7	-300	.158
1.60	-23.4	-306	.128
1.70	-25.8	-310	.107
1.80	-28.1	-313	.090
1.90	-30.2	-316	.078
2.00	-32.2	-319	.068
2.25	-36.7	-324	.051
2.50	-40.6	-328	.039
2.75	-44.1	-331	.032
3.00	-47.3	-334	.026
3.25	-50.2	-336	.022
3.50	-52.8	-338	.018
4.00	-57.6	-341	.014
5.00	-65.5	-345	.009
6.00	-71.9	-347	.006
7.00	-77.3	-349	.004
8.00	-82.0	-351	.003
9.00	-86.1	-352	.003
10.0	-89.8	-352	.002

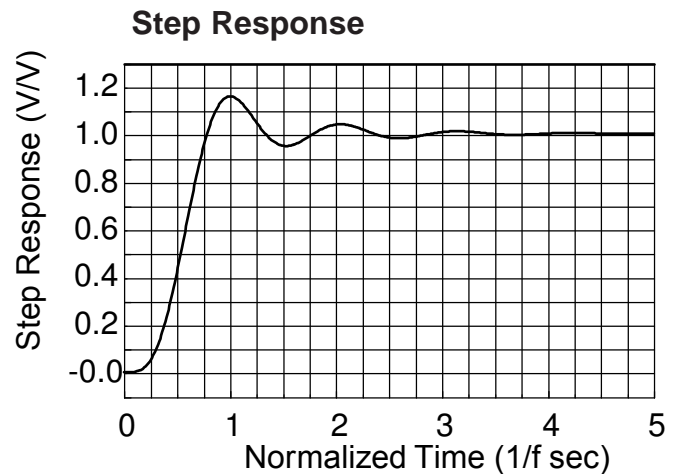
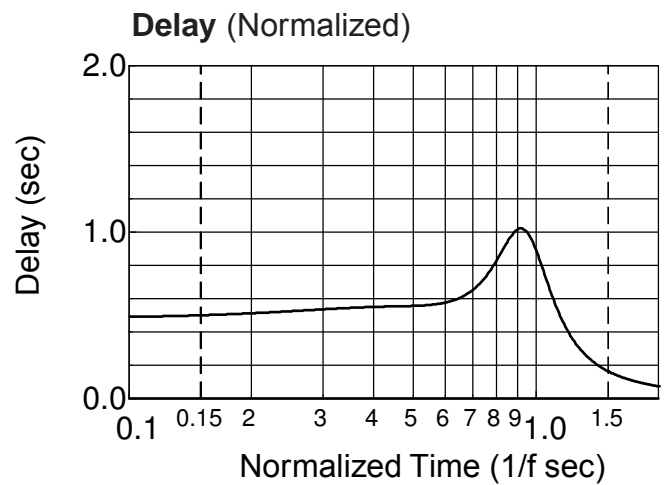
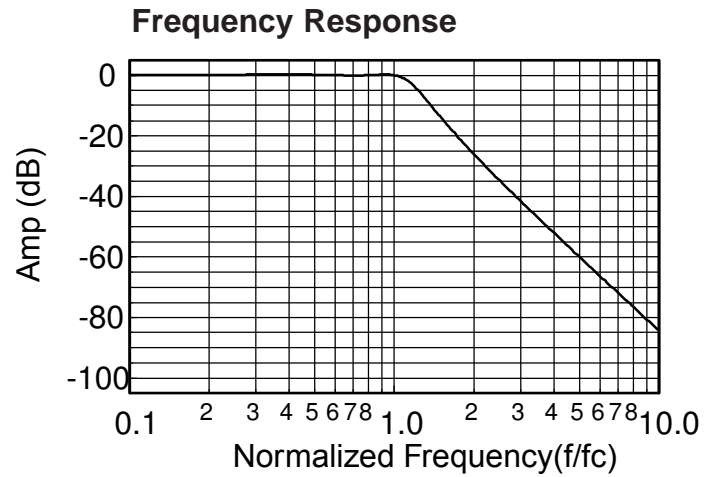

**1. Normalized Group Delay:**

The above delay data is normalized to a corner frequency of 1.0Hz. The actual delay is the normalized delay divided by the actual corner frequency (fc).

$$\text{Actual Delay} = \frac{\text{Normalized Delay}}{\text{Actual Corner Frequency (fc) in Hz}}$$



**Appendix A**

**Theoretical Transfer Characteristics**

f/fc (Hz)	Amp (dB)	Phase (deg)	Delay <sup>1</sup> (sec)
0.00	0.00	0.00	.476
0.10	0.087	-17.3	.492
0.20	0.295	-35.7	.533
0.30	0.474	-55.7	.577
0.40	0.463	-76.9	.596
0.50	0.248	-98.2	.583
0.60	0.025	-119	.578
0.70	0.072	-141	.647
0.80	0.432	-168	.881
0.85	0.482	-185	1.06
0.90	0.062	-205	1.18
0.95	-1.12	-226	1.13
1.00	-3.01	-245	.946
1.10	-7.61	-272	.559
1.20	-12.0	-288	.345
1.30	-15.9	-298	.235
1.40	-19.3	-305	.173
1.50	-22.4	-311	.134
1.60	-25.1	-315	.108
1.70	-27.6	-318	.089
1.80	-29.9	-321	.075
1.90	-32.1	-324	.065
2.00	-34.1	-326	.057
2.25	-38.6	-301	.042
2.50	-42.6	-334	.033
2.75	-46.1	-336	.026
3.00	-49.3	-339	.021
3.25	-52.2	-340	.018
3.50	-54.9	-342	.015
4.00	-59.7	-344	.011
5.00	-67.6	-347	.007
6.00	-74.0	-350	.005
7.00	-79.4	-351	.004
8.00	-84.1	-352	.003
9.00	-88.2	-353	.002
10.0	-91.9	-354	.002

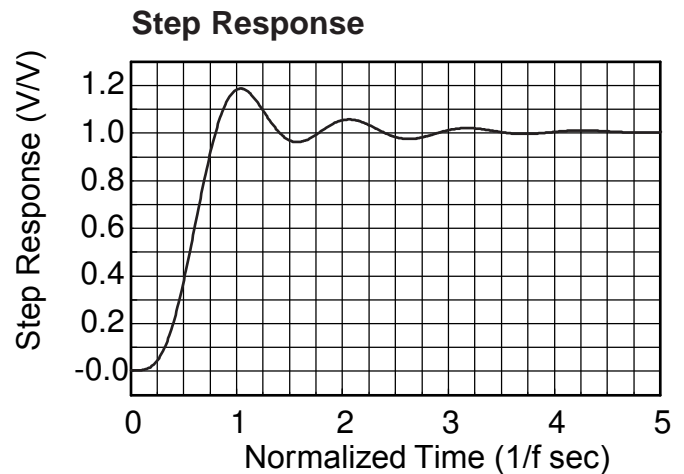
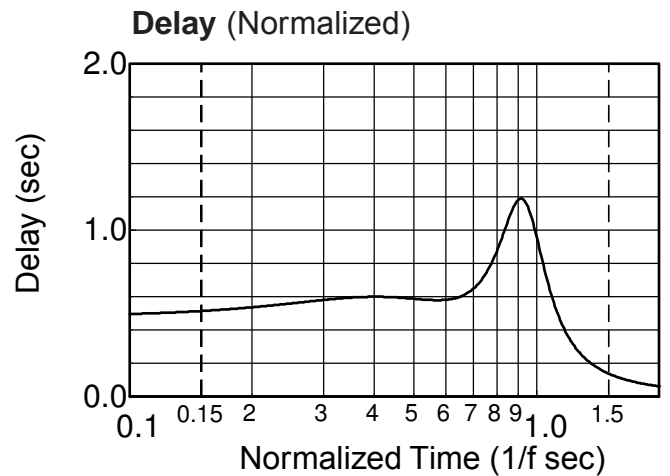
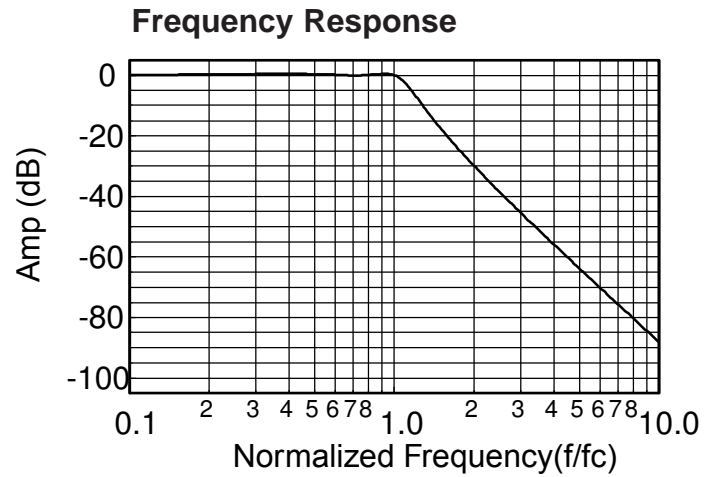

**1. Normalized Group Delay:**

The above delay data is normalized to a corner frequency of 1.0Hz. The actual delay is the normalized delay divided by the actual corner frequency (fc).

$$\text{Actual Delay} = \frac{\text{Normalized Delay}}{\text{Actual Corner Frequency (fc) in Hz}}$$



**Theoretical Transfer Characteristics**

<b>f/fc (Hz)</b>	<b>Amp (dB)</b>	<b>Phase (deg)</b>	<b>Delay<sup>1</sup> (sec)</b>
0.10	-80.0	345	.418
0.20	-55.9	330	.423
0.30	-41.8	314	.433
0.40	-31.8	299	.449
0.50	-24.1	282	.474
0.60	-17.8	264	.511
0.70	-12.6	245	.558
0.80	-8.43	224	.604
0.85	-6.69	213	.619
0.90	-5.22	202	.622
0.95	-3.99	191	.612
1.00	-3.01	180	.588
1.20	-0.908	143	.427
1.40	-0.285	118	.289
1.60	-0.100	100	.204
1.80	-0.039	87.6	.152
2.00	-0.017	78.0	.119
2.50	-0.003	61.4	.072
3.00	-0.001	50.7	.049
4.00	0.00	37.8	.027
5.00	0.00	30.1	.017
6.00	0.00	25.1	.012
7.00	0.00	21.4	.009
8.00	0.00	18.8	.007
9.00	0.00	16.7	.005
10.0	0.00	15.0	.004

**Frequency Response**

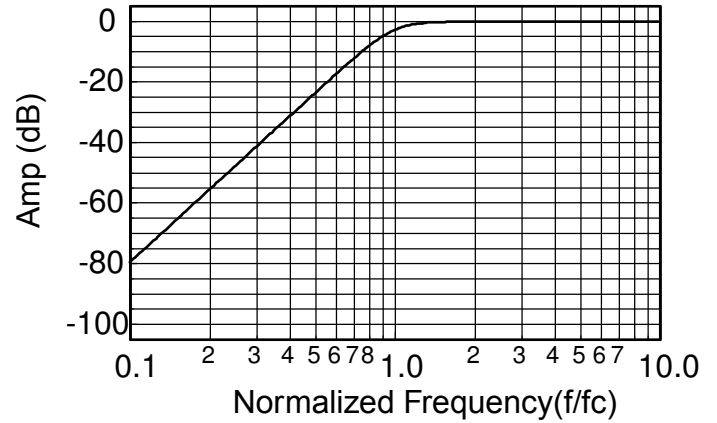

**1. Normalized Group Delay:**

The above delay data is normalized to a corner frequency of 1.0Hz. The actual delay is the normalized delay divided by the actual corner frequency (fc).

$$\text{Actual Delay} = \frac{\text{Normalized Delay}}{\text{Actual Corner Frequency (fc) in Hz}}$$



**Appendix A**

**Theoretical Transfer Characteristics**

f/fc (Hz)	Amp (dB)	Phase (deg)	Delay <sup>1</sup> (sec)
0.10	-89.8	352	.212
0.20	-65.1	345	.218
0.30	-51.1	337	.228
0.40	-40.6	328	.245
0.50	-32.2	319	.272
0.60	-25.0	308	.314
0.70	-18.6	296	.383
0.80	-12.7	280	.500
0.90	-7.34	259	.686
1.00	-3.01	231	.873
1.20	.140	172	.633
1.50	.031	128	.275
1.70	.003	111	.197
2.00	.074	93.2	.138
2.50	.174	73.4	.088
3.00	.200	60.4	.060
4.00	.170	44.5	.033
5.00	.129	35.2	.020
6.00	.098	29.2	.014
7.00	.076	24.9	.010
8.00	.060	21.7	.008
9.00	.048	19.3	.006
10.0	.040	17.3	.005

**Frequency Response**

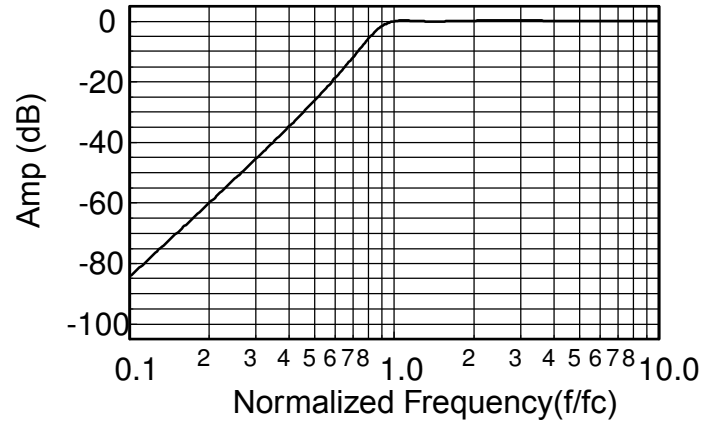

**1. Normalized Group Delay:**

The above delay data is normalized to a corner frequency of 1.0Hz. The actual delay is the normalized delay divided by the actual corner frequency (fc).

$$\text{Actual Delay} = \frac{\text{Normalized Delay}}{\text{Actual Corner Frequency (fc) in Hz}}$$



**Appendix A**

**Theoretical Transfer Characteristics**

<b>f/fc (Hz)</b>	<b>Amp (dB)</b>	<b>Phase (deg)</b>	<b>Delay<sup>1</sup> (sec)</b>
0.10	-91.9	354	.174
0.20	-67.6	347	.179
0.30	-53.1	341	.188
0.40	-42.6	334	.203
0.50	-34.1	326	.226
0.60	-26.8	317	.263
0.70	-20.2	307	.326
0.80	-14.0	293	.440
0.90	-8.13	274	.651
1.00	-3.01	245	.946
1.20	.500	179	.693
1.50	.014	133	.271
1.70	.043	117	.199
2.00	.249	98.2	.146
2.50	.469	76.9	.095
3.00	.498	62.7	.065
4.00	.401	45.5	.035
5.00	.296	35.7	.021
6.00	.221	29.4	.014
7.00	.169	25.0	.010
8.00	.133	21.8	.008
9.00	.107	19.3	.006
10.0	.088	17.3	.005

**Frequency Response**

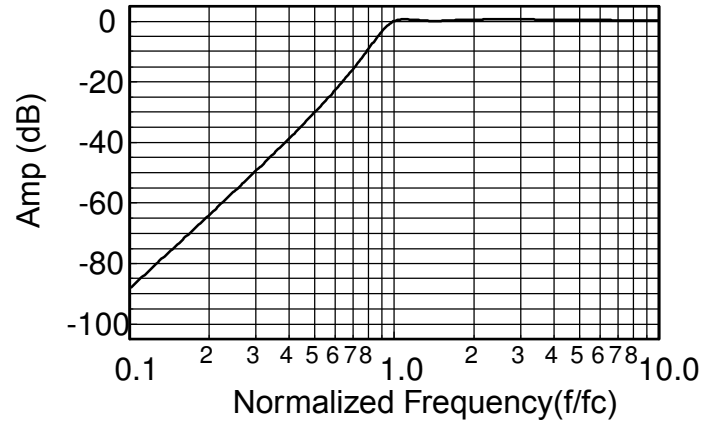

**1. Normalized Group Delay:**

The above delay data is normalized to a corner frequency of 1.0Hz. The actual delay is the normalized delay divided by the actual corner frequency (fc).

$$\text{Actual Delay} = \frac{\text{Normalized Delay}}{\text{Actual Corner Frequency (fc) in Hz}}$$