

4-Level Gray Scale 64×16 LCD Controller for I/O MCU

PATENTED
PAT No. : TW 099352

Technical Document

- [Tools Information](#)
- [FAQs](#)
- [Application Note](#)

Features

- Operating voltage: 2.7V~5.2V
- Built-in 32kHz RC oscillator
- External 32.768kHz crystal oscillator or 32kHz frequency source input
- Standby current: < 1μA at 3V, < 2μA at 5V
- Internal resistor type: 1/5 bias or 1/4 bias, 1/16 duty
- Two selectable LCD frame frequencies: 89Hz or 170Hz
- Max. 64×16 patterns, 64 segments and 16 commons
- Built-in bit-map display RAM: 2048 bits (=64×16×2 bits)
- Built-in internal resistor type bias generator
- Six-wire interface (four data wires)
- Eight kinds of time base/WDT selection
- Time base or WDT overflow output
- R/W address auto increment
- Built-in buzzer driver (2kHz/4kHz)
- Power down command reduces power consumption
- Software configuration feature
- Data mode and Command mode instructions
- Three data accessing modes
- Provides VLCD pin to adjust LCD operating voltage
- Provides three kinds of bias current programming
- Control of TN-type, STN-type LCDs and ECB-type LCDs
- Four-level gray scale output for TN-type, STN-type LCDs panel
- Four-color output for ECB-type LCDs panel
- 100-pin LQFP package and in chip form

Applications

- Leisure products
- Games
- Personal digital assistant
- Cellular phone
- Global positioning system
- Consumer electronics

General Description

HT1647 is a peripheral device specially designed for I/O type MCU used to expand the display capability. The max. display segment of the device are 1024 patterns (64 segments and 16 commons). It also supports four data bits interface, buzzer sound, Watchdog Timer or time base timer functions. The HT1647 is a memory mapping and multi-function LCD controller. Since the HT1647 can control ECB-type (Electrically Controlled Birefringence) LCDs in addition to current TN-type (Twisted Nematic) or STN-type (Super Twisted Nematic) LCDs, it can support 4-color display as well as

4-level gray scale display. It displays 4-level gray scale output when the HT1647 drives a TN-type, STN-type LCDs. It displays four color output when the HT1647 drives an ECB-type. HT1647 uses PWM (Pulse Width Modulation) technique. The software configuration feature of the HT1647 make it suitable for multiple LCD applications including LCD modules and display subsystems. Only six lines (\overline{CS} , \overline{WR} , DB0~DB3) are required for the interface between the host controller and the HT1647.

Pad Assignment

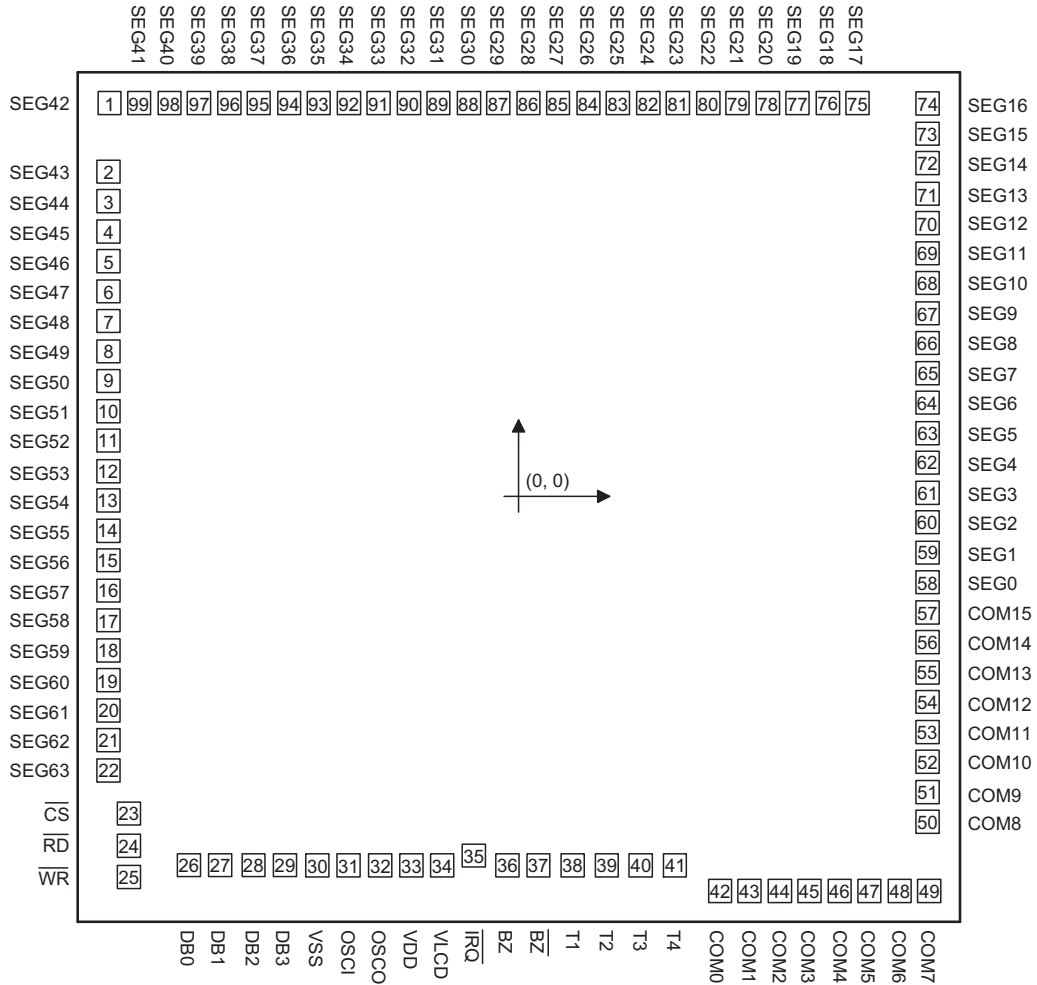

Chip size: 3865 × 3770 (μm)²

* The IC substrate should be connected to VSS in the PCB layout artwork.

Pad Coordinates

Unit: μm

Pad No.	X	Y	Pad No.	X	Y	Pad No.	X	Y
1	-1774.50	1708.30	34	-331.40	-1600.00	67	1775.70	795.30
2	-1779.30	1409.80	35	-194.50	-1558.30	68	1775.70	927.10
3	-1779.30	1281.80	36	-48.00	-1600.00	69	1775.70	1055.10
4	-1779.30	1150.00	37	87.40	-1600.00	70	1775.70	1186.90
5	-1779.30	1022.00	38	235.20	-1600.00	71	1775.70	1314.90
6	-1779.30	890.20	39	383.40	-1600.00	72	1775.70	1446.70
7	-1779.30	762.20	40	530.40	-1600.00	73	1775.70	1574.70
8	-1779.30	630.40	41	678.60	-1600.00	74	1775.70	1706.50
9	-1779.30	502.40	42	875.00	-1712.30	75	1471.10	1708.30
10	-1779.30	370.60	43	1003.00	-1712.30	76	1343.10	1708.30
11	-1779.30	242.60	44	1134.80	-1712.30	77	1211.30	1708.30
12	-1779.30	110.80	45	1262.80	-1712.30	78	1083.30	1708.30
13	-1779.30	-17.20	46	1394.60	-1712.30	79	951.50	1708.30

Pad No.	X	Y	Pad No.	X	Y	Pad No.	X	Y
14	-1779.30	-149.00	47	1522.60	-1712.30	80	823.50	1708.30
15	-1779.30	-277.00	48	1654.40	-1712.30	81	691.70	1708.30
16	-1779.30	-408.80	49	1782.40	-1712.30	82	563.70	1708.30
17	-1779.30	-536.80	50	1775.70	-1411.10	83	431.90	1708.30
18	-1779.30	-668.60	51	1775.70	-1283.10	84	303.90	1708.30
19	-1779.30	-796.60	52	1775.70	-1151.30	85	172.10	1708.30
20	-1779.30	-928.80	53	1775.70	-1023.30	86	44.10	1708.30
21	-1779.30	-1056.80	54	1775.70	-891.50	87	-87.70	1708.30
22	-1779.30	-1189.00	55	1775.70	-763.50	88	-215.70	1708.30
23	-1690.00	-1375.40	56	1775.70	-631.70	89	-347.50	1708.30
24	-1690.00	-1515.40	57	1775.70	-503.70	90	-475.50	1708.30
25	-1690.00	-1651.00	58	1775.70	-371.90	91	-607.30	1708.30
26	-1430.20	-1599.90	59	1775.70	-243.90	92	-735.30	1708.30
27	-1294.80	-1599.90	60	1775.70	-112.10	93	-867.10	1708.30
28	-1149.50	-1599.90	61	1775.70	15.90	94	-995.10	1708.30
29	-1013.90	-1599.90	62	1775.70	147.70	95	-1126.90	1708.30
30	-872.80	-1600.00	63	1775.70	275.70	96	-1254.90	1708.30
31	-738.30	-1600.00	64	1775.70	407.50	97	-1386.70	1708.30
32	-600.10	-1600.00	65	1775.70	535.50	98	-1514.70	1708.30
33	-465.60	-1600.00	66	1775.70	667.30	99	-1646.50	1708.30

Pad Description

Pad No.	Pad Name	I/O	Description
23	\overline{CS}	I	Chip selection input with pull-high resistor. When the \overline{CS} is logic high, the data and command read from or write to the HT1647 are disabled. The serial interface circuit is also reset. But if the \overline{CS} is at a logic low level and is input to the \overline{CS} pad, the data and command transmission between the host controller and the HT1647 are all enabled.
24	\overline{RD}	I	READ clock input with pull-high resistor. Data in the RAM of the HT1647 are clocked out on the rising edge of the \overline{RD} signal. The clocked out data will appear on the data line. The host controller can use the next falling edge to latch the clocked out data.
25	\overline{WR}	I	WRITE clock input with pull-high resistor. Data on the DATA line are latched into the HT1647 on the rising edge of the \overline{WR} signal.
26~29	DB0~DB3	I/O	Parallel data input/output with a pull-high resistor
30	VSS	—	Negative power supply for logic circuit, ground
31	OSCI	I	The OSCI and OSCO pads are connected to a 32.768kHz crystal in order to generate a system clock. If the system clock comes from an external clock source, the external clock source should be connected to the OSCI pad. But if an on-chip RC oscillator is selected, the OSCI and OSCO pads can be left open.
32	OSCO	O	
33	VDD	—	Positive power supply for logic circuit
34	VLCD	I	Power supply for LCD driver circuit
35	\overline{IRQ}	O	Time base or Watchdog Timer overflow flag, NMOS open drain output.
36, 37	BZ, \overline{BZ}	O	2kHz or 4kHz frequency output pair (tristate output buffer)
38~41	T1~T4	I	Not connected
42~57	COM0~COM15	O	LCD common outputs
58~99, 1~22	SEG0~SEG63	O	LCD segment outputs

Absolute Maximum Ratings

Supply Voltage $V_{SS}-0.3V$ to $V_{SS}+5.5V$ Storage Temperature $-50^{\circ}C$ to $125^{\circ}C$
 Input Voltage $V_{SS}-0.3V$ to $V_{DD}+0.3V$ Operating Temperature $-25^{\circ}C$ to $75^{\circ}C$

Note: These are stress ratings only. Stresses exceeding the range specified under "Absolute Maximum Ratings" may cause substantial damage to the device. Functional operation of this device at other conditions beyond those listed in the specification is not implied and prolonged exposure to extreme conditions may affect device reliability.

D.C. Characteristics

$T_a=25^{\circ}C$

Symbol	Parameter	Test Conditions		Min.	Typ.	Max.	Unit
		V _{DD}	Conditions				
V _{DD}	Operating Voltage	—	—	2.7	—	5.2	V
I _{DD1}	Operating Current	3V	No load/LCD ON	—	150	250	μA
		5V	On-chip RC oscillator	—	250	370	μA
I _{DD2}	Operating Current	3V	No load/LCD ON	—	135	200	μA
		5V	Crystal oscillator	—	200	300	μA
I _{DD11}	Operating Current	3V	No load/LCD OFF	—	15	30	μA
		5V	On-chip RC oscillator	—	50	70	μA
I _{DD22}	Operating Current	3V	No load/LCD OFF	—	2	10	μA
		5V	Crystal oscillator	—	3	10	μA
I _{STB}	Standby Current	3V	No load, Power down mode	—	—	1	μA
		5V		—	—	2	μA
V _{IL}	Input Low Voltage	3V	DB0~DB3, \overline{WR} , \overline{CS} , \overline{RD}	0	—	0.6	V
		5V		0	—	1.0	V
V _{IH}	Input High Voltage	3V	DB0~DB3, \overline{WR} , \overline{CS} , \overline{RD}	2.4	—	3	V
		5V		4.0	—	5	V
I _{OL1}	BZ, \overline{BZ} , \overline{IRQ} Sink Current	3V	V _{OL} =0.3V	1.2	2.5	—	mA
		5V	V _{OL} =0.5V	3	6	—	mA
I _{OH1}	BZ, \overline{BZ} Source Current	3V	V _{OH} =2.7V	-0.9	-1.8	—	mA
		5V	V _{OH} =4.5V	-2	-4	—	mA
I _{OL2}	DB0~DB3 Sink Current	3V	V _{OL} =0.3V	1.2	2.5	—	mA
		5V	V _{OL} =0.5V	3	6	—	mA
I _{OH2}	DB0~DB3 Source Current	3V	V _{OH} =2.7V	-0.9	-1.8	—	mA
		5V	V _{OH} =4.5V	-2	-4	—	mA
I _{OL3}	LCD Common Sink Current	3V	V _{OL} =0.3V	80	160	—	μA
		5V	V _{OL} =0.5V	180	360	—	μA
I _{OH3}	LCD Common Source Current	3V	V _{OH} =2.7V	-40	-80	—	μA
		5V	V _{OH} =4.5V	-90	-180	—	μA
I _{OL4}	LCD Segment Sink Current	3V	V _{OL} =0.3V	50	100	—	μA
		5V	V _{OL} =0.5V	120	240	—	μA
I _{OH4}	LCD Segment Source Current	3V	V _{OH} =2.7V	-30	-60	—	μA
		5V	V _{OH} =4.5V	-70	-140	—	μA
R _{PH}	Pull-high Resistor	3V	DB0~DB3, \overline{WR} , \overline{CS} , \overline{RD}	150	250	410	kΩ
		5V		60	125	210	kΩ

A.C. Characteristics

Ta=25°C

Symbol	Parameter	Test Conditions		Min.	Typ.	Max.	Unit
		V _{DD}	Conditions				
f _{SYS1}	System Clock	3V	On-chip RC oscillator	22	32	40	kHz
		5V		24	32	40	
f _{SYS2}	System Clock	3V	Crystal oscillator	—	32.768	—	kHz
		5V		—	32.768	—	
f _{SYS3}	System Clock	3V	External clock source	—	32	—	kHz
		5V		—	32	—	
f _{LCD1}	LCD Frame Frequency	3V	On-chip RC oscillator	61/117	89/170	111/213	Hz
		5V		61/117	89/170	111/213	
f _{LCD2}	LCD Frame Frequency	3V	Crystal oscillator	—	64	—	Hz
		5V		—	64	—	
f _{LCD3}	LCD Frame Frequency	3V	External clock source	—	64	—	Hz
		5V		—	64	—	
t _{COM}	LCD Common Period	—	n: Number of COM	—	n/f _{LCD}	—	sec
f _{CLK1}	4-Bit Data Clock (\overline{WR} Pin)	3V	Duty cycle 50%	—	—	150	kHz
		5V		—	—	300	
f _{CLK2}	4-Bit Data Clock (\overline{RD} Pin)	3V	Duty cycle 50%	—	—	75	kHz
		5V		—	—	150	
t _{CS}	4-Bit Interface Reset Pulse Width (Figure 3)	—	\overline{CS}	—	250	—	ns
t _{CLK}	\overline{WR} , \overline{RD} Input Pulse Width (Figure 1)	3V	Write mode	3.34	—	—	μ s
			Read mode	6.67			
		5V	Write mode	1.67	—	—	μ s
			Read mode	3.34			
t _r , t _f	Rise/Fall Time Serial Data Clock Width (Figure 1)	3V	—	—	120	—	ns
		5V					
t _{su}	Setup Time for DB to \overline{WR} , \overline{RD} Clock Width (Figure 2)	3V	—	—	120	—	ns
		5V					
t _h	Hold Time for DB to \overline{WR} , \overline{RD} Clock Width (Figure 2)	3V	—	—	120	—	ns
		5V					
t _{su1}	Setup Time for \overline{CS} to \overline{WR} , \overline{RD} Clock Width (Figure 3)	3V	—	—	100	—	ns
		5V					
t _{h1}	Hold Time for \overline{CS} to \overline{WR} , \overline{RD} Clock Width (Figure 3)	3V	—	—	100	—	ns
		5V					

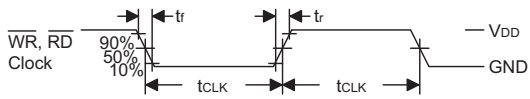

Figure 1

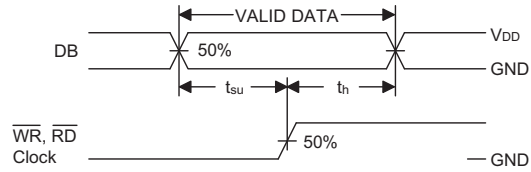

Figure 2

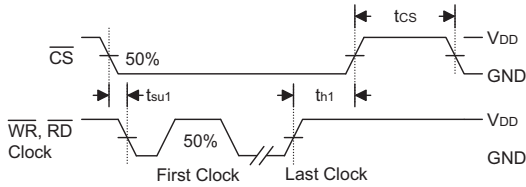

Figure 3

Functional Description

System Oscillator

The HT1647 system clock is used to generate the time base/Watchdog Timer (WDT) clock frequency, LCD driving clock, and tone frequency. The clock source may be from an on-chip RC oscillator (32kHz), a crystal oscillator (32.768kHz), or an external 32kHz clock by the S/W setting. The configuration of the system oscillator is as shown. After the SYS DIS command is executed, the system clock will stop and the LCD bias generator will turn off. That command is available only for the on-chip RC oscillator or for the crystal oscillator. Once the system clock stops, the LCD display will become blank, and the time base/WDT loses its function as well.

The LCD OFF command is used to turn the LCD bias generator off. After the LCD bias generator switches off by issuing the LCD OFF command, using the SYS DIS command reduces power consumption, thus serving as

a system power down command. But if the external clock source is chosen as the system clock, using the SYS DIS command can neither turn the oscillator off nor carry out the power down mode. The crystal oscillator option can be applied to connect an external frequency source of 32kHz to the OSC1 pin. In this case, the system fails to enter the power down mode, similar to the case in the external 32kHz clock source operation. At the initial system power on, the HT1647 is at the SYS DIS state.

Display Memory – RAM Structure

The static display RAM is organized into 512×4 bits and stores the display data. The contents of the RAM are directly mapped to the contents of the LCD driver. Data in the RAM can be accessed by the READ, WRITE and READ-MODIFY-WRITE commands. The following is a mapping from the RAM to the LCD patterns.

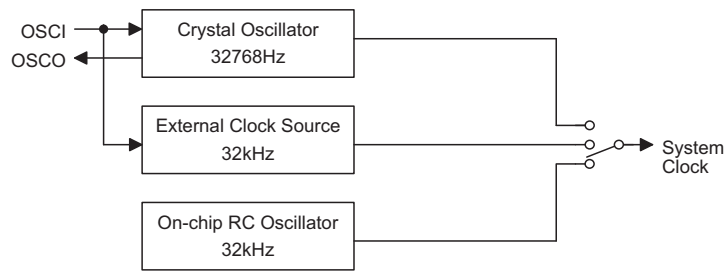

System Oscillator Configuration

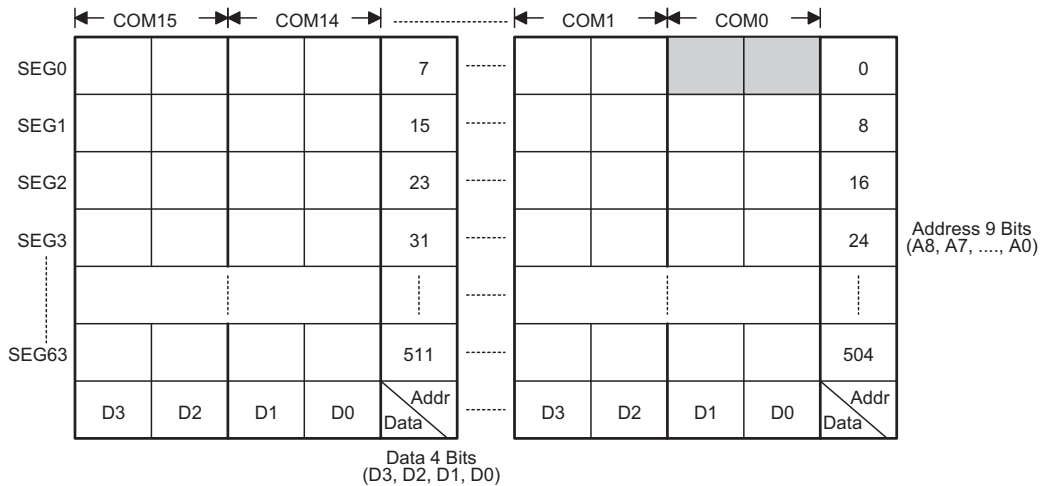

 : Two bits of RAM map to LCD's one pixel and decide 4-level gray scale or 4-color display concurrently.

Display Memory – RAM Structure

Gray Scale Level Decision

HT1647 uses PWM technique to provide 4-level gray scale display. Two bits of RAM data code ((D3, D2) or (D1, D0)) decide one pixel level of LCDs, level 1~level divided by 4. Every level must be defined as one kind of gray scale by PWM data (namely B4~B0) previously.

RAM Data Code (D3, D2) or (D1, D0)	Choice Gray Scale Level
(1, 1)	Level 1
(1, 0)	Level 2
(0, 1)	Level 3
(0, 0)	Level 4

RAM Data Defined Gray Scale Level

Frame Frequency

HT1647 provides two kinds of frame frequency option by command code; 89Hz and 170Hz respectively. FRAME 89Hz provides 89Hz frame frequency and active segment signal width can be divided into 24 sections concurrently. FRAME 170Hz provides 170Hz frame frequency and active segment signal width can be divided into 13 sections concurrently. The 24 sections display a particularly gray scale more than the 13 sections by PWM data. The default is FRAME 89Hz.

Name	Command Code	Function
FRAME 170Hz	X100-0001-1000-XXXX	Select 170Hz frame frequency and active segment signal width can be divided into 13 sections
FRAME 89Hz	X100-0001-1101-XXXX	Select 89Hz frame frequency and active segment signal width can be divided into 24 sections

Frame Frequency Selection Command Code

Gray Scale Display

If the user choose 89Hz frame frequency, a max. of 24 sections can be programmed to suit a satisfactory gray scale in every level. Similarly, if the user choose 170Hz frame frequency, a max. of 13 sections can be programmed to suit a satisfactory gray scale in every level. HT1647 provides 5-bit PWM data to control the length of the section. In other words, a max. Of 24 gray scales are generated by 5-bit binary PWM data. At FRAME 89Hz mode, the HT1647 only provides a max. of 24 adjustable gray scales although 32 is the expressed max. value by 5 bits binary code. When 5 bits binary code value is more than 23, the PWM control circuit uniformly regards 23. To increase PWM data indicates to increase the length of the active segment signal. The varied length of the active segment signal displays varied gray scale in TN-type, STN-type LCDs (refer to table 1). Similarly, it displays varied color in ECB-type LCDs. The color display is derived from ECB-type LCD specification. At FRAME 170Hz mode, the HT1647 only provides a max. of 13 adjustable gray scales although 32 is the expressed max. value by 5 bits binary code. When the 5 bits binary code value is more than 12, the PWM control circuit uniformly regards 12. The user must appoint four kinds of PWM data to four kinds of different gray scale level by commanding PWM data (refer to table 2).

Relationship Table between PWM Data and Gray Scale

Value	5 bits PWM data					PWM (ON width)	Gray Scale
	B4	B3	B2	B1	B0		
0	0	0	0	0	0	0 (0/23)	
1	0	0	0	0	1	1/23	
2	0	0	0	1	0	2/23	
3	0	0	0	1	1	3/23	
4	0	0	1	0	0	4/23	
5	0	0	1	0	1	5/23	
6	0	0	1	1	0	6/23	
7	0	0	1	1	1	7/23	
8	0	1	0	0	0	8/23	
9	0	1	0	0	1	9/23	
10	0	1	0	1	0	10/23	
11	0	1	0	1	1	11/23	
12	0	1	1	0	0	12/23	
13	0	1	1	0	1	13/23	
14	0	1	1	1	0	14/23	
15	0	1	1	1	1	15/23	
16	1	0	0	0	0	16/23	
17	1	0	0	0	1	17/23	
18	1	0	0	1	0	18/23	
19	1	0	0	1	1	19/23	
20	1	0	1	0	0	20/23	
21	1	0	1	0	1	21/23	
22	1	0	1	1	0	22/23	
23	1	0	1	1	1	1 (23/23)	
24	1	1	0	0	0	1 (24/23)	
...	
31	1	1	1	1	1	1 (31/23)	

Table 1: FRAME 89Hz Mode

Value	5 bits PWM data					PWM (ON width)	Gray Scale
	B4	B3	B2	B1	B0		
0	0	0	0	0	0	0 (0/12)	
1	0	0	0	0	1	1/12	
2	0	0	0	1	0	2/12	
3	0	0	0	1	1	3/12	
4	0	0	1	0	0	4/12	
5	0	0	1	0	1	5/12	
6	0	0	1	1	0	6/12	
7	0	0	1	1	1	7/12	
8	0	1	0	0	0	8/12	
9	0	1	0	0	1	9/12	
10	0	1	0	1	0	10/12	
11	0	1	0	1	1	11/12	
12	0	1	1	0	0	1 (12/12)	
13	0	1	1	0	1	1 (13/12)	
...	
31	1	1	1	1	1	1 (31/12)	

Table 2: FRAME 170Hz Mode

Note: The varied PWM data displays various gray scale in TN-type, STN-type LCDs.

The color display derives from ECB-type LCD's specification.

Name	Command Code	Function
GRS LEVEL 1	X100-001 B4-B3 B2 B1 B0-XXXX	Set PWM data in gray scale level 1
GRS LEVEL 2	X100-010 B4-B3 B2 B1 B0-XXXX	Set PWM data in gray scale level 2
GRS LEVEL 3	X100-011 B4-B3 B2 B1 B0-XXXX	Set PWM data in gray scale level 3
GRS LEVEL 4	X100-100 B4-B3 B2 B1 B0-XXXX	Set PWM data in gray scale level 4

Four Kinds of Gray Scale Level Command Code

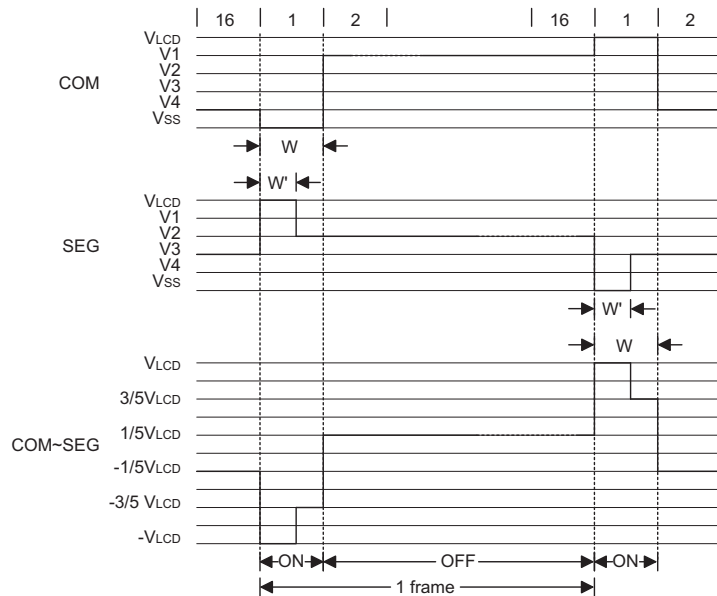

Note: "W" Real active segment signal width (adjustable width by PWM data)
 "W" Max. active segment signal width
 PWM (ON width): W/W, 0 ≤ W/W ≤ 1 (refer to table 1 & tabel 2)

Example of Waveform (B Type) in 1/5 Bias, 1/16 Duty Cycle Drive

Time Base and Watchdog Timer – WDT

The time base generator and WDT share the same counter which is divided by 256. The $\overline{\text{IRQ}}$ clock can be programmed as 1Hz, 2Hz, ..., 128Hz output. TIMER DIS/EN/CLR, WDT DIS/EN/CLR and $\overline{\text{IRQ}}$ EN/DIS are independent from each other. Once the WDT time-out occurs, the $\overline{\text{IRQ}}$ pin will remain at a logic low level until the CLR WDT or the $\overline{\text{IRQ}}$ DIS command is issued.

If an external clock is selected as the system frequency source, the SYS DIS command turns out invalid and the power down mode fails to be carried out until the external clock source is removed.

Buzzer Tone Output

A simple tone generator is implemented in the HT1647. The tone generator can output a pair of differential driving signals on the BZ and $\overline{\text{BZ}}$ which are used to generate a single tone.

By executing the TONE 4K and TONE 2K commands there are two tone frequency outputs selectable that can turn on the tone output. The TONE 4K and TONE 2K commands set the tone frequency to 4kHz and 2kHz, respectively. The tone output can be turned off by invoking the TONE OFF command. The tone outputs, namely BZ and $\overline{\text{BZ}}$, are a pair of differential driving outputs used to drive a piezo buzzer. Once the system is disabled or the tone output is inhibited, the BZ and the $\overline{\text{BZ}}$ outputs will remain at low level.

Command Format

The HT1647 can be configured by software setting. There are two mode commands to configure the HT1647 resource and to transfer the LCD display data.

The configuration mode of the HT1647 is called command mode, and its command mode ID is 100. The command mode consists of a system configuration command, a system frequency selection command, an LCD configuration command, a tone frequency selection command, a bias current selection command, a gray scale level selection command, a timer/WDT setting command, and an operating command. The data mode, on the other hand, includes READ, WRITE, and READ-MODIFY-WRITE operations.

The following are the data mode ID and the command mode ID:

Operation	Mode	ID
READ	Data	110
WRITE	Data	101
READ-MODIFY-WRITE	Data	101
COMMAND	Command	100

If successive commands have been issued, the command mode ID can be omitted. While the system is operating in the non-successive command or the non-successive address data mode, the CS pin should be set to "1" and the previous operation mode will also be reset. The $\overline{\text{CS}}$ pin returns to "0", so a new operation mode ID should be issued first.

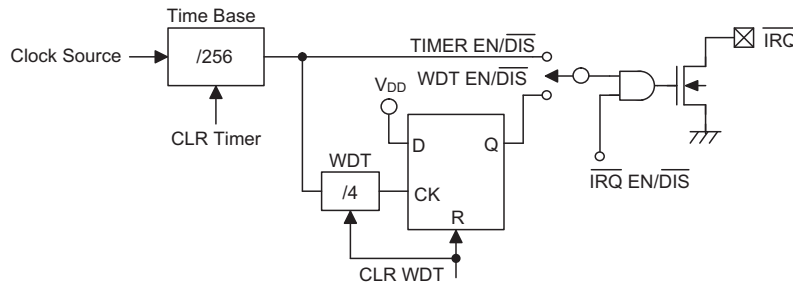

Time Base and WDT Configurations

Name	Command Code	Function
TONE OFF	X100-0000-1000-XXXX	Turn-off tone output
TONE 4K	X100-0001-0000-XXXX	Turn-on tone output, tone frequency is 4kHz
TONE 2K	X100-0001-0001-XXXX	Turn-on tone output, tone frequency is 2kHz

Buzzer Tone Output Command Code

Bias Generator

The HT1647 bias voltage belongs to internal resistor type. It provides two kinds of bias option named 1/5 bias and 1/4 bias respectively. It is recommended to select 1/5 bias to fit TN-type, STN-type LCDs and select 1/4 bias to fit ECB-type LCDs. It also provides three kinds of bias current option by programming to suitably drive an LCD panel. The three kinds of bias current are large,

middle, and small, respectively. Usually, large panel LCD can be excellently displayed by large bias current. Relatively, it consumes large current when LCD ON command is used. Small bias current provides low power consumption during On condition when the LCD is normally displayed. The following are the reference value table.

V _{LCD}	Bias	Large Bias Current	Middle Bias Current	Small Bias Current
4V	1/5	300μA	100μA	40μA
4V	1/4	375μA	125μA	50μA

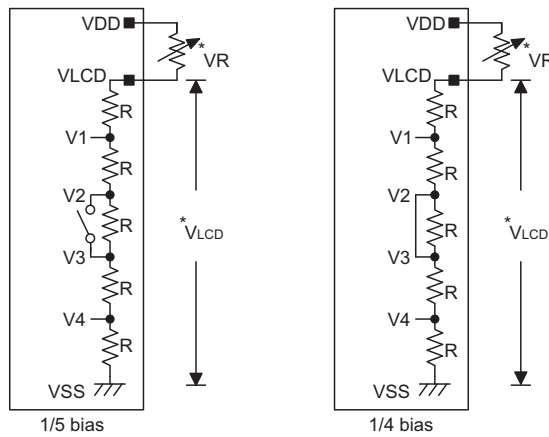

* The voltage applied to VLCD pin must be equal to or lower than VDD.
 * Adjust VR to fit LCD display, at V_{DD}=5V, V_{LCD}=4V, VR=15kΩ±20%.

Internal Resistor Type Bias Generator Configurations

Interfacing

Only six lines are required to interface with the HT1647. The CS line is used to initialize the serial interface circuit and to terminate the communication between the host controller and the HT1647. If the CS pin is set to 1, the data and command issued between the host controller and the HT1647 are first disabled and then initialized. Before issuing a mode command or mode switching, a high level pulse is required to initialize the serial interface of the HT1647. The DB0~DB3 are the 4-bit parallel data input/output lines. Data to be read or written or commands to be written have to pass through the DB0~DB3 lines. The RD line is the READ clock input. Data in the RAM are clocked out on the falling edge of the

RD signal, and the clocked out data will then appear on the DB0~DB3 lines. It is recommended that the host controller read correct data during the interval between the rising edge and the next falling edge of the RD signal. The WR line is the WRITE clock input. The data, address, and command on the DB0~DB3 lines are all clocked into the HT1647 on the rising edge of the WR signal. There is an optional IRQ line to be used as an interface between the host controller and the HT1647. The IRQ pin can be selected as a timer output or a WDT overflow flag output by the S/W setting. The host controller can perform the time base or the WDT function by connecting with the IRQ pin of the HT1647.

Timing Diagrams

READ mode (command ID code : 1 1 0)

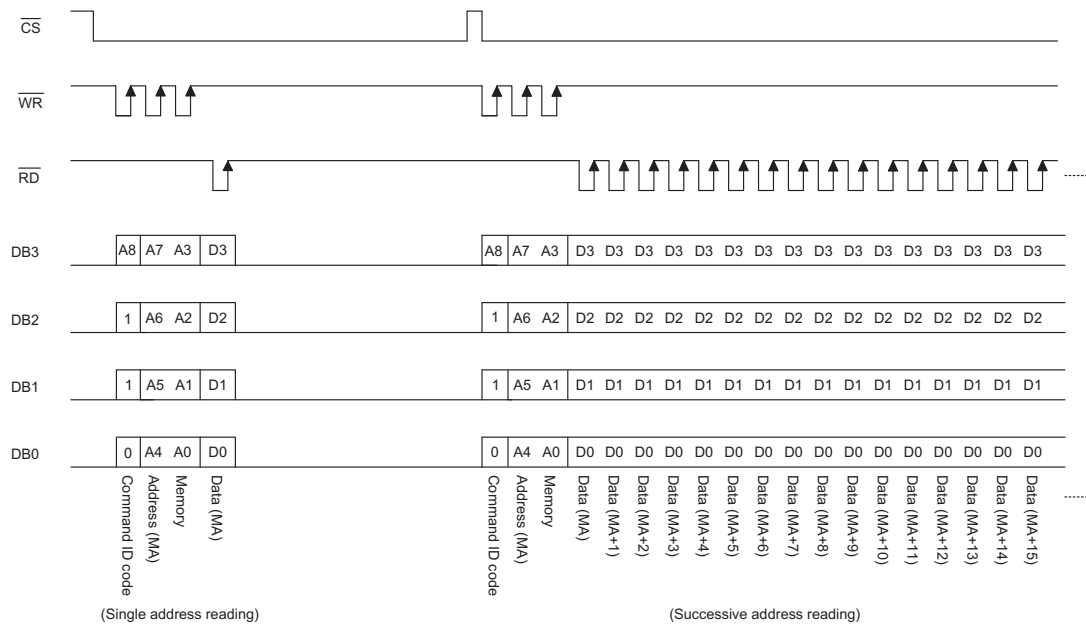

WRITE mode (command ID code : 1 0 1)

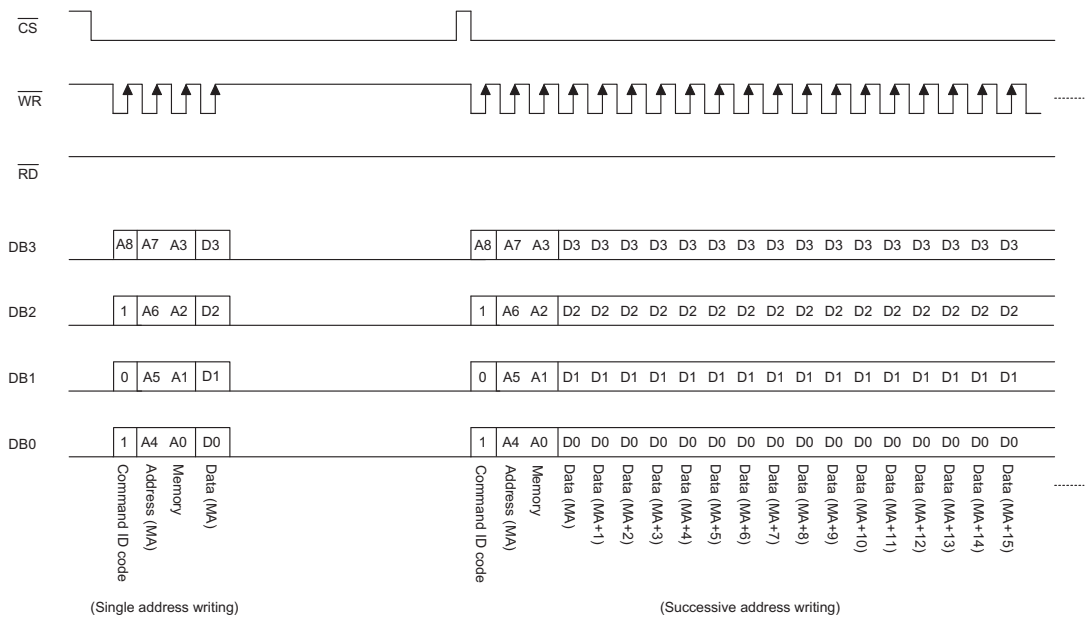

READ-MODIFY-WRITE mode (command ID code : 1 0 1)

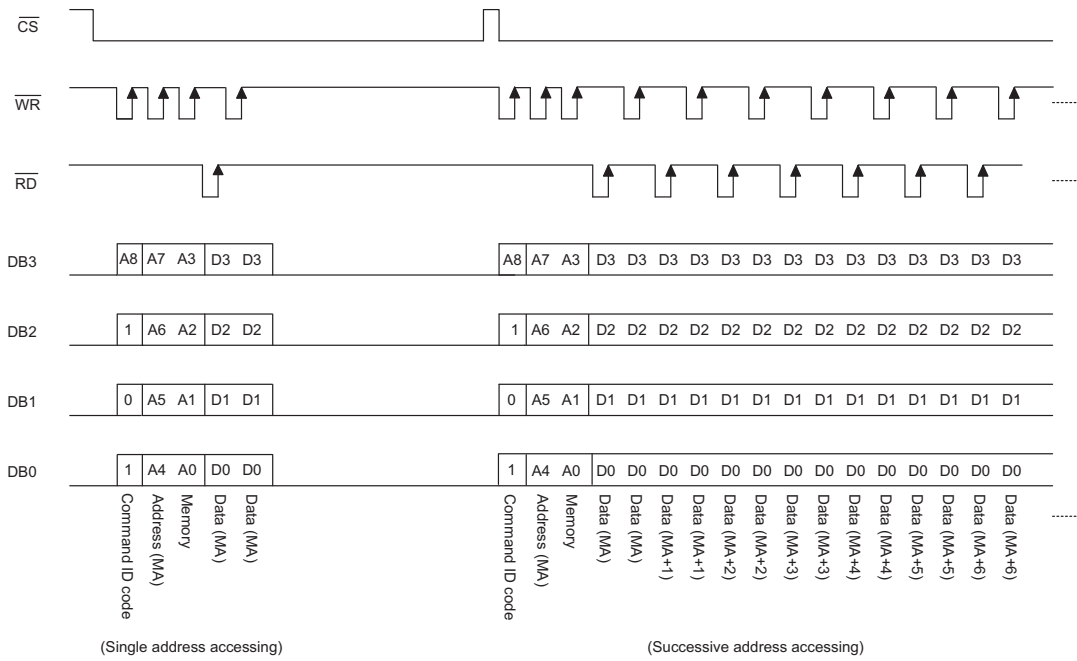

Command mode (command ID code : 1 0 0)

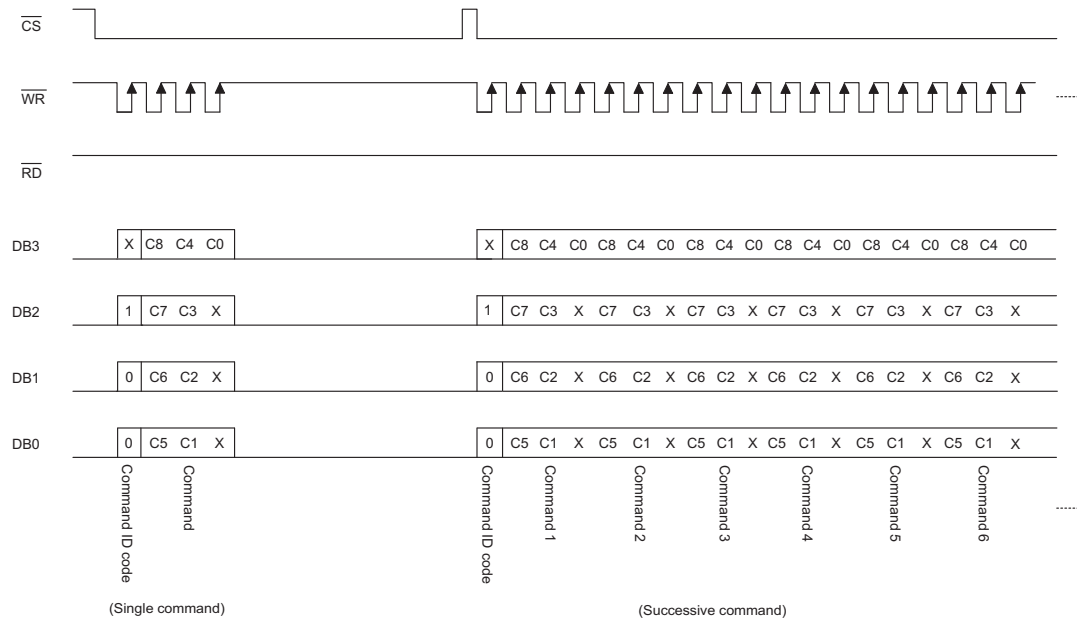

Note: "X" stands for don't care

Application Circuits

Host Controller with an HT1647 Display System

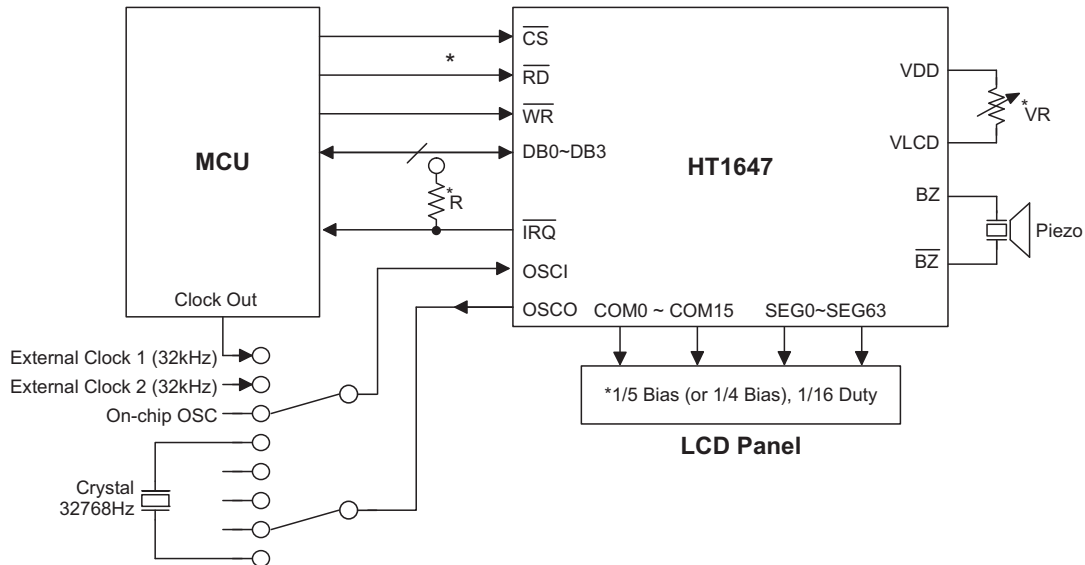

*Note: The connection of \overline{IRQ} and \overline{RD} pin can be selected depending on the MCU.

The voltage applied to V_{LCD} pin must be equal to or lower than V_{DD} .

Adjust VR to fit LCD display, at $V_{DD}=5V$, $V_{LCD}=4V$, $VR=15k\Omega \pm 20\%$.

It is recommended to select 1/5 bias to fit TN-type, STN-type LCDs and select 1/4 bias to fit ECB-type LCDs.

Adjust R (external pull high resistance) to fit user's time base clock.

Instruction Set Summary

Name	Command Code	D/C	Function	Def.
READ	A8110-A7A6A5A4A3A2A1A0D3D2D1D0	D	Read data from the RAM	
WRITE	A8101-A7A6A5A4A3A2A1A0D3D2D1D0	D	Write data to the RAM	
READ-MODIFY-WRITE	A8101-A7A6A5A4A3A2A1A0D3D2D1D0	D	Read and Write data to the RAM	
SYS DIS	X100-0000-0000-XXXX	C	Turn Off both system oscillator and LCD bias generator	Yes
SYS EN	X100-0000-0001-XXXX	C	Turn On system oscillator	
LCD OFF	X100-0000-0010-XXXX	C	Turn Off LCD display	Yes
LCD ON	X100-0000-0011-XXXX	C	Turn On LCD display	
TIMER DIS	X100-0000-0100-XXXX	C	Disable time base output	Yes
WDT DIS	X100-0000-0101-XXXX	C	Disable WDT time-out flag output	Yes
TIMER EN	X100-0000-0110-XXXX	C	Enable time base output	
WDT EN	X100-0000-0111-XXXX	C	Enable WDT time-out flag output	
TONE OFF	X100-0000-1000-XXXX	C	Turn Off tone outputs	Yes
CLR TIMER	X100-0000-1101-XXXX	C	Clear the contents of the time base generator	
CLR WDT	X100-0000-1111-XXXX	C	Clear the contents of the WDT stage	
TONE 4K	X100-0001-0000-XXXX	C	Turn on tone output, tone frequency output: 4kHz	
TONE 2K	X100-0001-0001-XXXX	C	Turn on tone output, tone frequency output: 2kHz	

Name	Command Code	D/C	Function	Def.
IRQ DIS	X 100 -0001-0010-XXXX	C	Disable $\overline{\text{IRQ}}$ output	Yes
IRQ EN	X 100 -0001-0011-XXXX	C	Enable $\overline{\text{IRQ}}$ output	
RC 32K	X 100 -0001-0100-XXXX	C	System clock source, on-chip RC oscillator	Yes
EXT (XTAL)	X 100 -0001-0101-XXXX	C	System clock source, external 32kHz clock source or crystal oscillator 32.768kHz	
LARGE BIAS	X 100 -0001-0110-XXXX	C	Large bias current option	Yes
MIDDLE BIAS	X 100 -0001-0111-XXXX	C	Middle bias current option	
SMALL BIAS	X 100 -0001-1000-XXXX	C	Small bias current option	
BIAS 1/5	X 100 -0001-1001-XXXX	C	LCD 1/5 bias option	Yes
BIAS 1/4	X 100 -0001-1010-XXXX	C	LCD 1/4 bias option	
FRAME 170Hz	X 100 -0001-1100-XXXX	C	Selects 170Hz frame frequency and active segment signal width can be divided into 13 sections	
FRAME 89Hz	X 100 -0001-1101-XXXX	C	Selects 89Hz frame frequency and active segment signal width can be divided into 24 sections	Yes
GRS LEVEL1	X 100 -001 B4-B3 B2 B1 B0-XXXX	C	Sets PWM data in gray scale level 1	
GRS LEVEL2	X 100 -010 B4-B3 B2 B1 B0-XXXX	C	Sets PWM data in gray scale level 2	
GRS LEVEL3	X 100 -011 B4-B3 B2 B1 B0-XXXX	C	Sets PWM data in gray scale level 3	
GRS LEVEL4	X 100 -100 B4-B3 B2 B1 B0-XXXX	C	Sets PWM data in gray scale level 4	
F1	X 100 -1010-0000-XXXX	C	Time base clock output: 1Hz The WDT time-out flag after: 4s	
F2	X 100 -1010-0001-XXXX	C	Time base clock output: 2Hz The WDT time-out flag after: 2s	
F4	X 100 -1010-0010-XXXX	C	Time base clock output: 4Hz The WDT time-out flag after: 1s	
F8	X 100 -1010-0011-XXXX	C	Time base clock output: 8Hz The WDT time-out flag after: 1/2s	
F16	X 100 -1010-0100-XXXX	C	Time base clock output: 16Hz The WDT time-out flag after: 1/4s	
F32	X 100 -1010-0101-XXXX	C	Time base clock output: 32Hz The WDT time-out flag after: 1/8s	
F64	X 100 -1010-0110-XXXX	C	Time base clock output: 64Hz The WDT time-out flag after: 1/16s	
F128	X 100 -1010-0111-XXXX	C	Time base clock output: 128Hz The WDT time-out flag after: 1/32s	Yes
TEST	X 100 -1111-1111-XXXX	C	Test mode, user don't use.	
NORMAL	X 100 -1111-1110-XXXX	C	Normal mode	Yes

Note: "X" stands for don't care

A8~A0: RAM address

D3~D0: RAM data

B4~B0: PWM data

D/C: Data/Command mode

Def.: Power-on reset default

All the bold forms, namely **1 1 0**, **1 0 1**, and **1 0 0**, are mode commands. Of these, **1 0 0** indicates the command mode ID. If successive commands have been issued, the command mode ID except for the first command will be omitted. The tone frequency source and the time base/WDT clock frequency source can be derived from an on-chip 32kHz RC oscillator, a 32.768kHz crystal oscillator, or an external 32kHz clock. Calculation of the frequency is based on the system frequency sources as stated above. It is recommended that the host controller should initialize the HT1647 after power-on reset, otherwise, power on reset may fail, which in turn leads to the malfunctioning of the HT1647.

Package Information

100-pin LQFP (14mm×14mm) Outline Dimensions

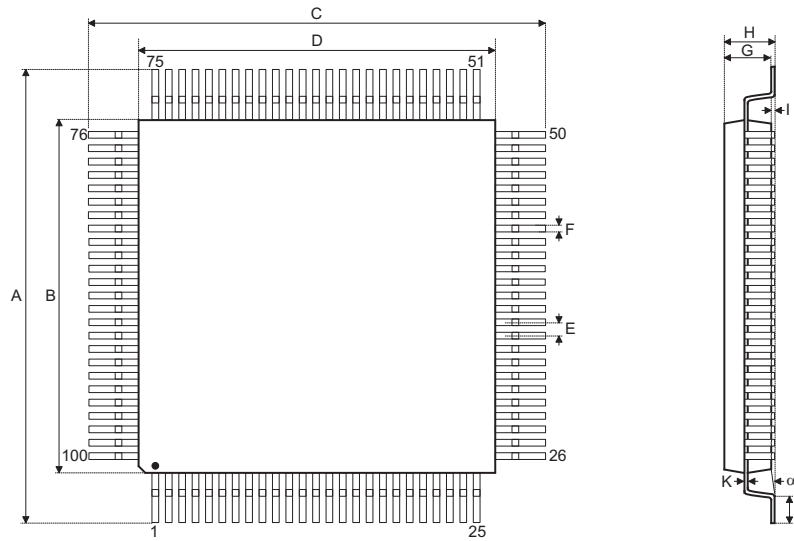

Symbol	Dimensions in inch		
	Min.	Nom.	Max.
A	0.626	—	0.634
B	0.547	—	0.555
C	0.626	—	0.634
D	0.547	—	0.555
E	—	0.020	—
F	—	0.008	—
G	0.053	—	0.057
H	—	—	0.063
I	—	0.004	—
J	0.018	—	0.030
K	0.004	—	0.008
α	0°	—	7°

Symbol	Dimensions in mm		
	Min.	Nom.	Max.
A	15.90	—	16.10
B	13.90	—	14.10
C	15.90	—	16.10
D	13.90	—	14.10
E	—	0.50	—
F	—	0.20	—
G	1.35	—	1.45
H	—	—	1.60
I	—	0.10	—
J	0.45	—	0.75
K	0.10	—	0.20
α	0°	—	7°

Copyright © 2011 by HOLTEK SEMICONDUCTOR INC.

The information appearing in this Data Sheet is believed to be accurate at the time of publication. However, Holtek assumes no responsibility arising from the use of the specifications described. The applications mentioned herein are used solely for the purpose of illustration and Holtek makes no warranty or representation that such applications will be suitable without further modification, nor recommends the use of its products for application that may present a risk to human life due to malfunction or otherwise. Holtek's products are not authorized for use as critical components in life support devices or systems. Holtek reserves the right to alter its products without prior notification. For the most up-to-date information, please visit our web site at <http://www.holtek.com.tw>.