



## SEMITOP® 1

### Antiparallel Thyristor Module

#### SK 25 KQ

#### Preliminary Data

#### Features

- Compact Design
- One screw mounting
- Heat transfer and isolation through direct copper bonded aluminium oxide ceramic (DBC)
- Glass passivated thyristor chips
- Up to 1600V reverse voltage
- UL recognized, file no. E 63 532

#### Typical Applications\*

- Soft starters
- Light control (studios, theaters...)
- Temperature control

| $V_{RSM}$<br>V | $V_{RRM}, V_{DRM}$<br>V | $I_{RMS} = 29 \text{ A A (full conduction)}$<br>( $T_s = 85^\circ \text{C}$ ) |
|----------------|-------------------------|---|
| 900            | 800                     | SK 25 KQ 08   |
| 1300           | 1200                    | SK 25 KQ 12   |
| 1700           | 1600                    | SK 25 KQ 16   |

| Symbol           | Conditions   | Values       | Units             |
|------------------|--|--------------|-------------------|
| $I_{RMS}$        | W1C ; sin. $180^\circ$ ; $T_s = 100^\circ \text{C}$                                      | 20           | A                 |
|                  | W1C ; sin. $180^\circ$ ; $T_s = 85^\circ \text{C}$                                       | 29           | A                 |
| $I_{TSM}$        | $T_{vj} = 25^\circ \text{C}$ ; 10 ms   | 320          | A                 |
|                  | $T_{vj} = 125^\circ \text{C}$ ; 10 ms  | 280          | A                 |
| $i^2t$           | $T_{vj} = 25^\circ \text{C}$ ; 8,3...10 ms   | 510          | A <sup>2</sup> s  |
|                  | $T_{vj} = 125^\circ \text{C}$ ; 8,3...10 ms  | 390          | A <sup>2</sup> s  |
| $V_T$            | $T_{vj} = 25^\circ \text{C}$ , $I_T = 75 \text{ A}$                                      | max. 2,45    | V                 |
| $V_{T(TO)}$      | $T_{vj} = 125^\circ \text{C}$  | max. 1,1     | V                 |
| $r_T$            | $T_{vj} = 125^\circ \text{C}$  | max. 20      | m $\Omega$        |
| $I_{DD}, I_{RD}$ | $T_{vj} = 125^\circ \text{C}$ , $V_{RD} = V_{RRM}$                                       | max. 8       | mA                |
| $t_{gd}$         | $T_{vj} = 25^\circ \text{C}$ , $I_G = 1 \text{ A}$ ; $di_G/dt = 1 \text{ A}/\mu\text{s}$ | 1            | $\mu\text{s}$     |
| $t_{gr}$         | $V_D = 0,67 * V_{DRM}$   | 1            | $\mu\text{s}$     |
| $(dv/dt)_{cr}$   | $T_{vj} = 125^\circ \text{C}$  | 1000         | V/ $\mu\text{s}$  |
| $(di/dt)_{cr}$   | $T_{vj} = 125^\circ \text{C}$ ; $f = 50...60 \text{ Hz}$                                 | 50           | A/ $\mu\text{s}$  |
| $t_q$            | $T_{vj} = 125^\circ \text{C}$ ; typ.   | 80           | $\mu\text{s}$     |
| $I_H$            | $T_{vj} = 25^\circ \text{C}$ ; typ. / max.   | 80 / 150     | mA                |
| $I_L$            | $T_{vj} = 25^\circ \text{C}$ ; $R_G = 33 \Omega$ ; typ. / max.                           | 150 / 300    | mA                |
| $V_{GT}$         | $T_{vj} = 25^\circ \text{C}$ ; d.c.  | min. 2       | V                 |
| $I_{GT}$         | $T_{vj} = 25^\circ \text{C}$ ; d.c.  | min. 100     | mA                |
| $V_{GD}$         | $T_{vj} = 125^\circ \text{C}$ ; d.c.   | max. 0,25    | V                 |
| $I_{GD}$         | $T_{vj} = 125^\circ \text{C}$ ; d.c.   | max. 3       | mA                |
| $R_{th(j-s)}$    | cont. per thyristor  | 1,7          | K/W               |
|                  | sin $180^\circ$ per thyristor  | 1,78         | K/W               |
| $R_{th(j-s)}$    | cont. per W1C  | 0,85         | K/W               |
|                  | sin $180^\circ$ per W1C  | 0,89         | K/W               |
| $T_{vj}$         |  | -40 ... +125 | $^\circ \text{C}$ |
| $T_{stg}$        |  | -40 ... +125 | $^\circ \text{C}$ |
| $T_{solder}$     | terminals, 10s   | 260          | $^\circ \text{C}$ |
| $V_{isol}$       | a. c. 50 Hz; r.m.s.; 1 s / 1 min.  | 3000 / 2500  | V~                |
| $M_s$            | Mounting torque to heatsink  | 1,5          | Nm                |
| $M_t$            |  |              | Nm                |
| $a$              |  |              | m/s <sup>2</sup>  |
| $m$              |  | 13           | g                 |
| Case             | SEMITOP® 1   | T 1          |                   |

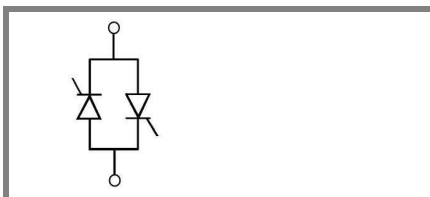

KQ

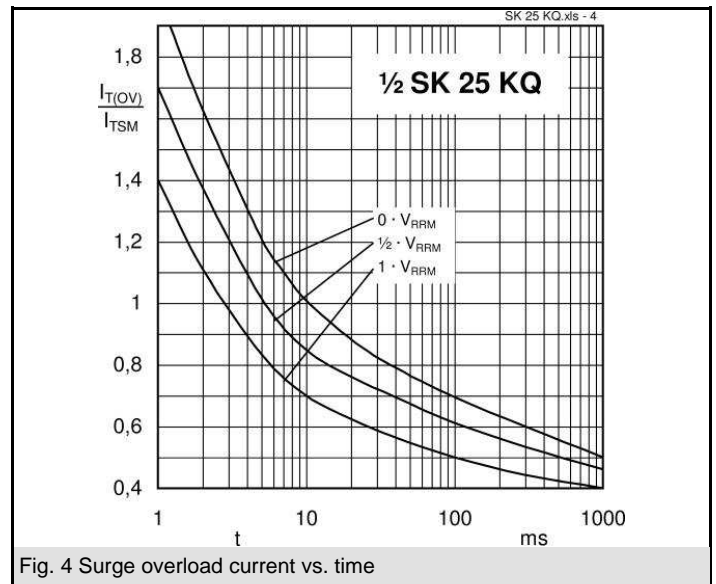
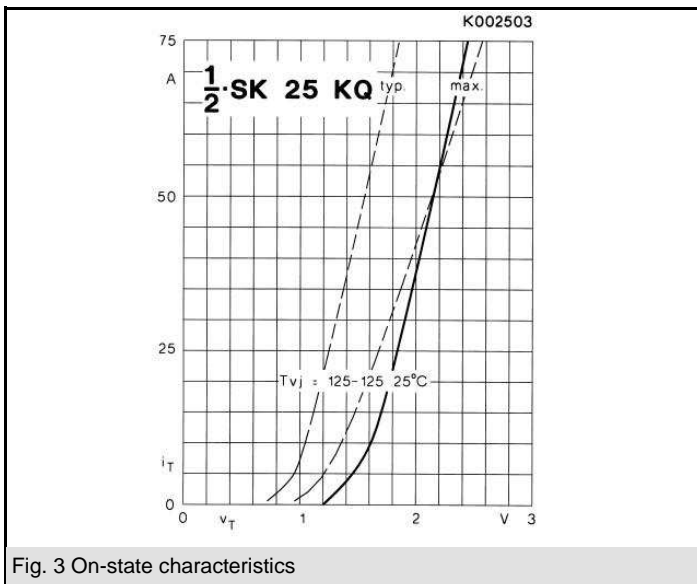
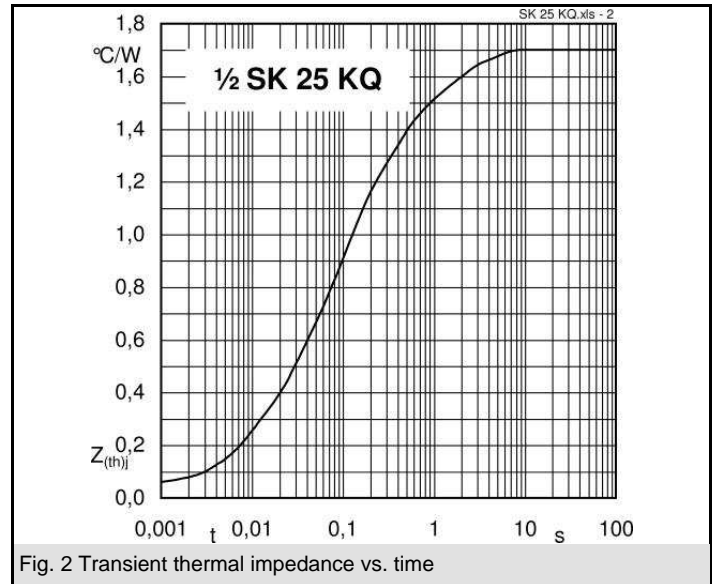
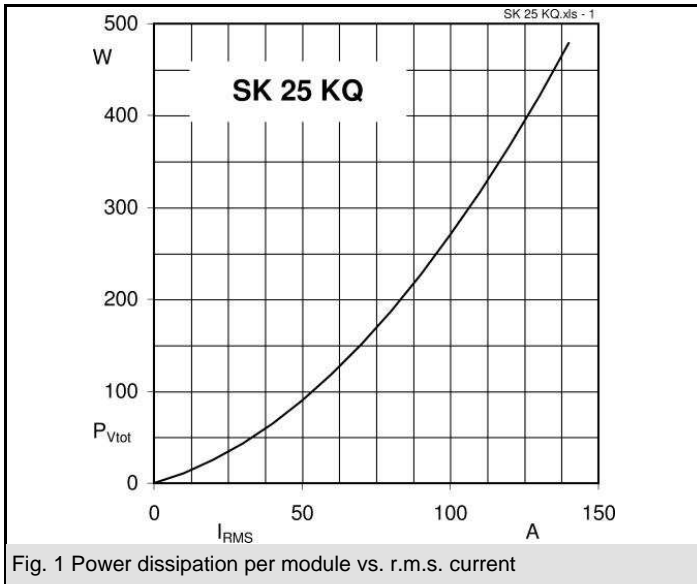

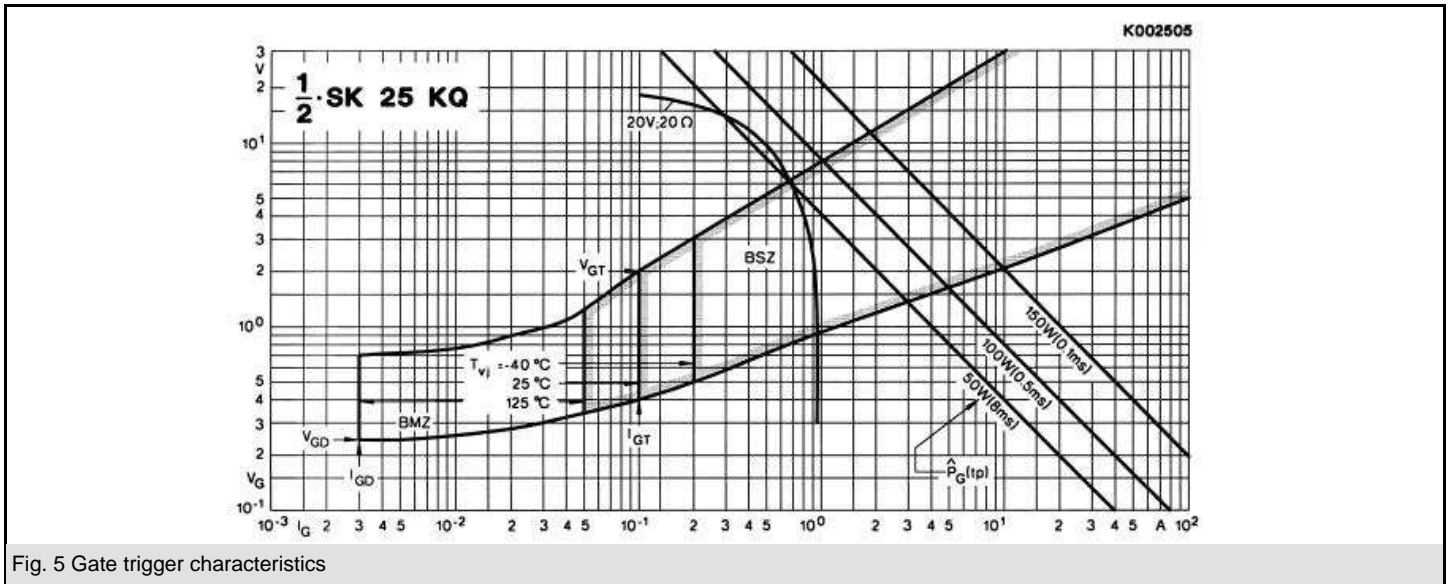
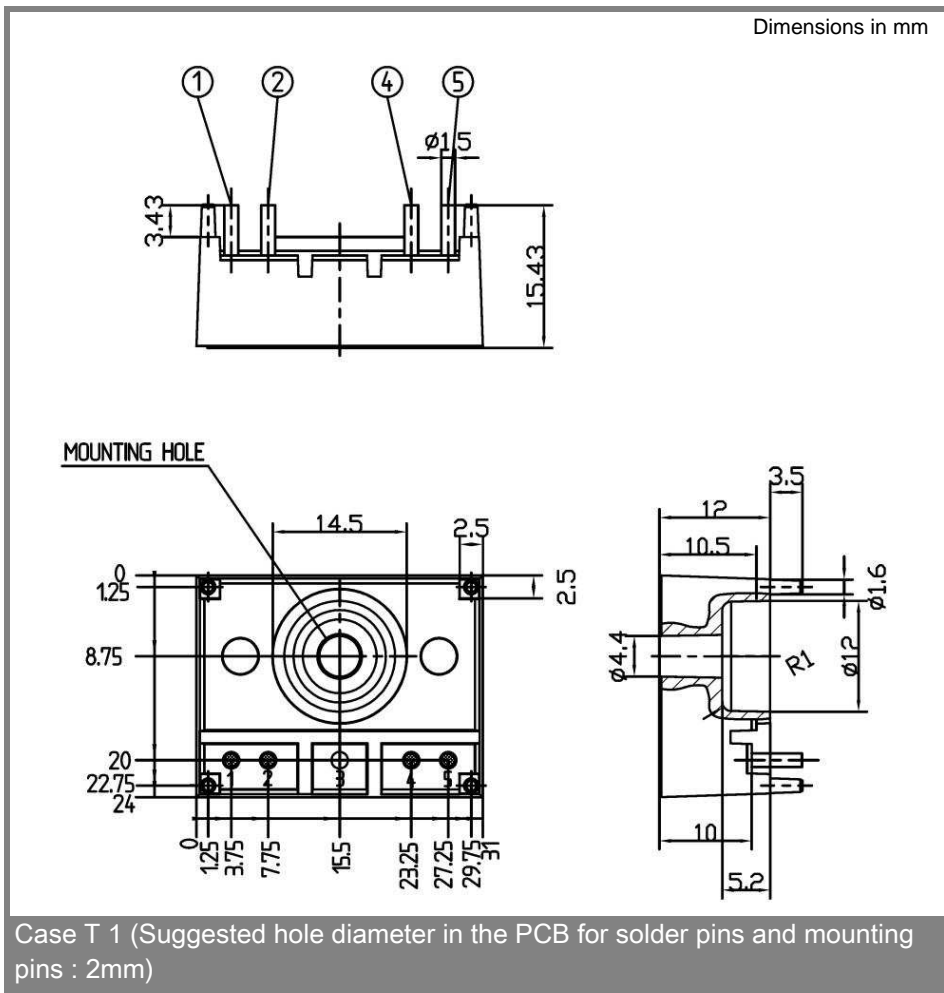
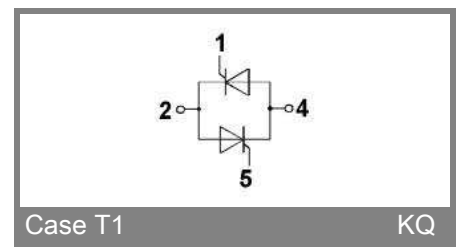

Fig. 5 Gate trigger characteristics



Case T 1 (Suggested hole diameter in the PCB for solder pins and mounting pins : 2mm)



\* The specifications of our components may not be considered as an assurance of component characteristics. Components have to be tested for the respective application. Adjustments may be necessary. The use of SEMIKRON products in life support appliances and systems is subject to prior specification and written approval by SEMIKRON. We therefore strongly recommend prior consultation of our personal.