

SKiiP 24NAB126V1

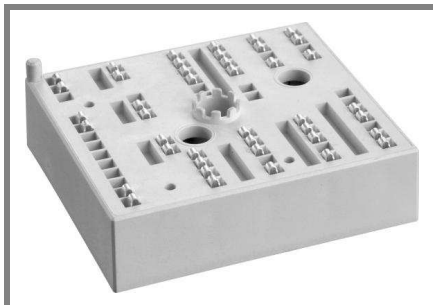

MiniSKiiP[®] 2

3-phase bridge rectifier +
brake chopper + 3-phase
bridge inverter
SKiiP 24NAB126V1

Features

- Fast Trench IGBTs
- Robust and soft freewheeling diodes in CAL technology
- Highly reliable spring contacts for electrical connections
- UL recognised file no. E63532

Typical Applications*

- Inverter up to 19 kVA
- Typical motor power 11 kW

Remarks

- V_{CEsat} , V_F = chip level value

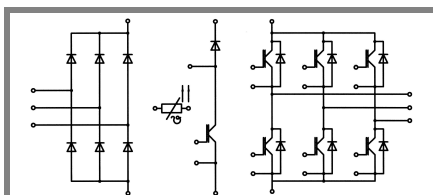

NAB

Absolute Maximum Ratings		$T_s = 25\text{ °C}$, unless otherwise specified		
Symbol	Conditions	Values	Units	
IGBT - Inverter, Chopper				
V_{CES}	$T_s = 25\text{ (70) °C}$	1200	V	
I_C		52 (40)	A	
I_{CRM}		70	A	
V_{GES}		± 20	V	
T_j		- 40 ... + 150	°C	
Diode - Inverter, Chopper				
I_F	$T_s = 25\text{ (70) °C}$	38 (29)	A	
I_{FRM}		70	A	
T_j		- 40 ... + 150	°C	
Diode - Rectifier				
V_{RRM}	$T_s = 70\text{ °C}$	1600	V	
I_F		46	A	
I_{FSM}		$t_p = 10\text{ ms, sin } 180\text{ °, } T_j = 25\text{ °C}$	370	A
i^2t		$t_p = 10\text{ ms, sin } 180\text{ °, } T_j = 25\text{ °C}$	680	A ² s
T_j		- 40 ... + 150	°C	
Module				
I_{RMS}	per power terminal (20 A / spring)	40	A	
T_{stg}		- 40 ... + 125	°C	
V_{isol}	AC, 1 min.	2500	V	

Characteristics		$T_s = 25\text{ °C}$, unless otherwise specified			
Symbol	Conditions	min.	typ.	max.	Units
IGBT - Inverter, Chopper					
V_{CEsat}	$I_{Cnom} = 35\text{ A, } T_j = 25\text{ (125) °C}$		1,7 (2)	2,1 (2,4)	V
$V_{GE(th)}$	$V_{GE} = V_{CE}, I_C = 1,5\text{ mA}$	5	5,8	6,5	V
$V_{CE(TO)}$	$T_j = 25\text{ (125) °C}$		1 (0,9)	1,2 (1,1)	V
r_T	$T_j = 25\text{ (125) °C}$		20 (31)	26 (37)	mΩ
C_{ies}	$V_{CE} = 25\text{ V, } V_{GE} = 0\text{ V, } f = 1\text{ MHz}$		2,4		nF
C_{oes}	$V_{CE} = 25\text{ V, } V_{GE} = 0\text{ V, } f = 1\text{ MHz}$		0,5		nF
C_{res}	$V_{CE} = 25\text{ V, } V_{GE} = 0\text{ V, } f = 1\text{ MHz}$		0,3		nF
$R_{th(j-s)}$	per IGBT		0,75		K/W
$t_{d(on)}$	under following conditions		80		ns
t_r	$V_{CC} = 600\text{ V, } V_{GE} = \pm 15\text{ V}$		30		ns
$t_{d(off)}$	$I_{Cnom} = 35\text{ A, } T_j = 125\text{ °C}$		410		ns
t_f	$R_{Gon} = R_{Goff} = 15\text{ Ω}$		120		ns
E_{on}	inductive load		4,6		mJ
E_{off}			4		mJ
Diode - Inverter, Chopper					
$V_F = V_{EC}$	$I_{Fnom} = 35\text{ A, } T_j = 25\text{ (125) °C}$		1,8 (1,8)	2,1 (2,2)	V
$V_{(TO)}$	$T_j = 25\text{ (125) °C}$		1 (0,8)	1,1 (0,9)	V
r_T	$T_j = 25\text{ (125) °C}$		23 (31)	29 (37)	mΩ
$R_{th(j-s)}$	per diode		1,5		K/W
I_{RRM}	under following conditions		43		A
Q_{rr}	$I_{Fnom} = 35\text{ A, } V_R = 600\text{ V}$		7		μC
E_{rr}	$V_{GE} = 0\text{ V, } T_j = 125\text{ °C}$		3,3		mJ
	$di_F/dt = 1450\text{ A/μs}$				
Diode - Rectifier					
V_F	$I_{Fnom} = 25\text{ A, } T_j = 25\text{ °C}$		1,1		V
$V_{(TO)}$	$T_j = 150\text{ °C}$		0,8		V
r_T	$T_j = 150\text{ °C}$		13		mΩ
$R_{th(j-s)}$	per diode		1,25		K/W
Temperature Sensor					
R_{ts}	3 %, $T_r = 25\text{ (100) °C}$		1000(1670)		Ω
Mechanical Data					
w			65		g
M_s	Mounting torque	2		2,5	Nm

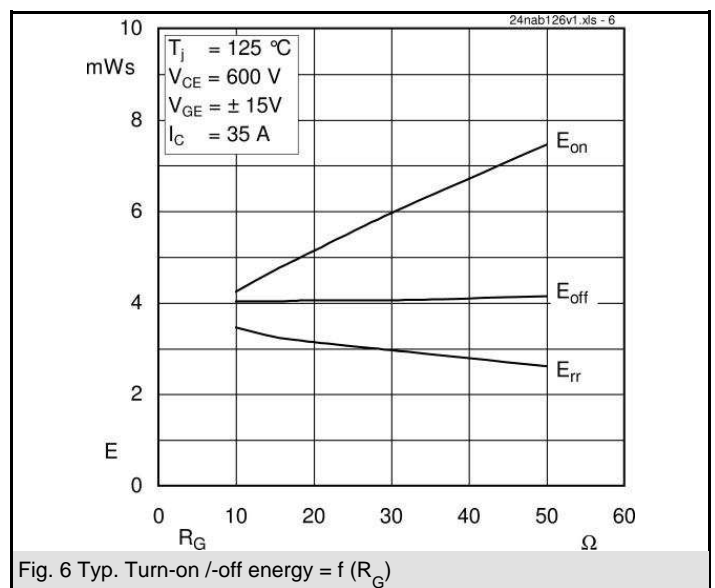
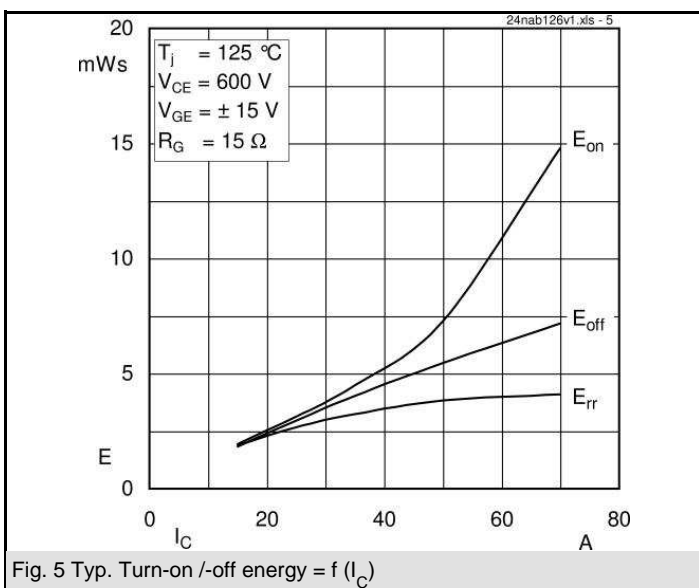
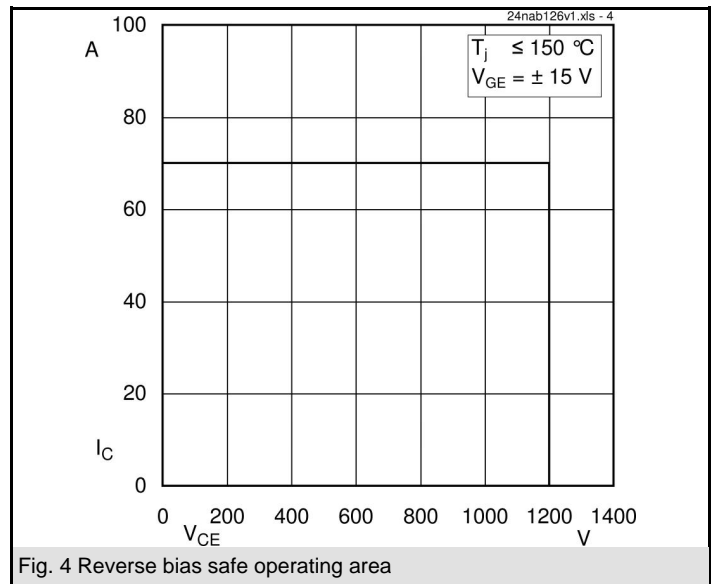
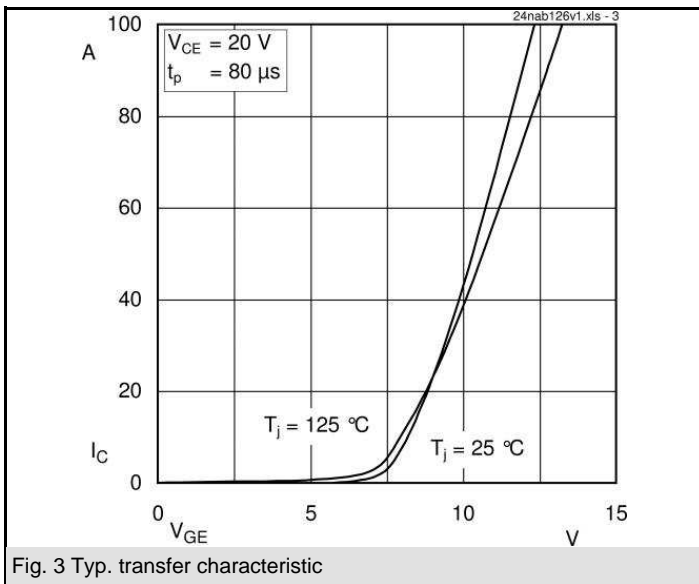
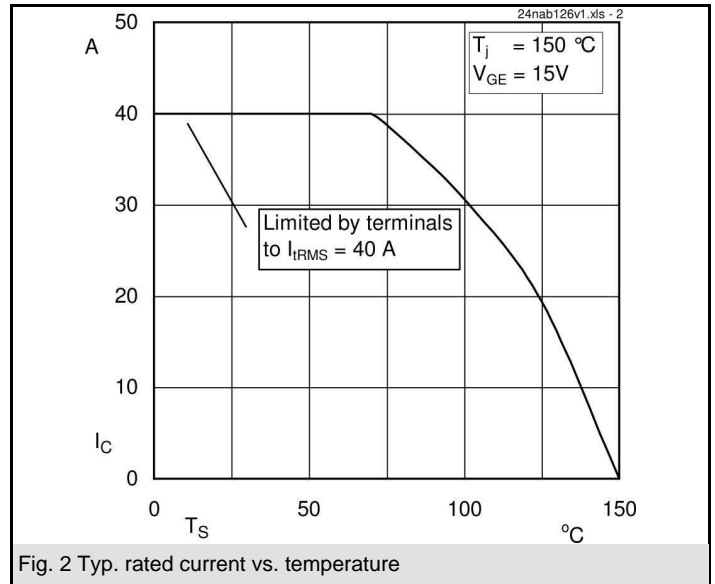
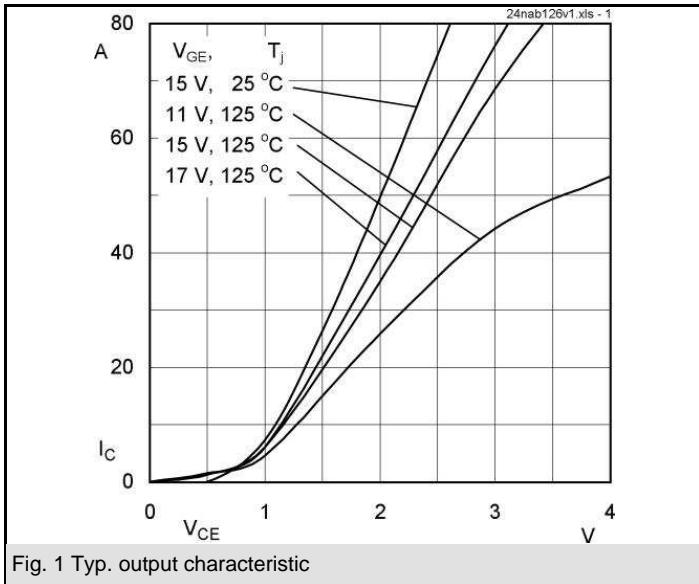

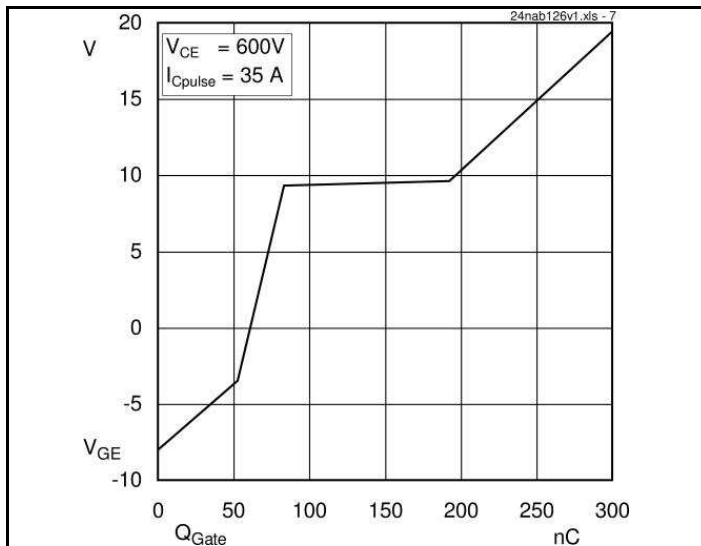

Fig. 7 Typ. gate charge characteristic

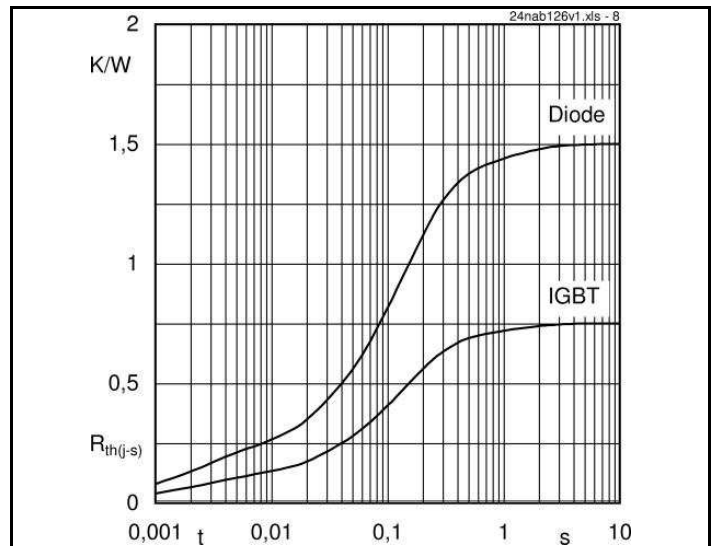

Fig. 8 Typ. thermal impedance

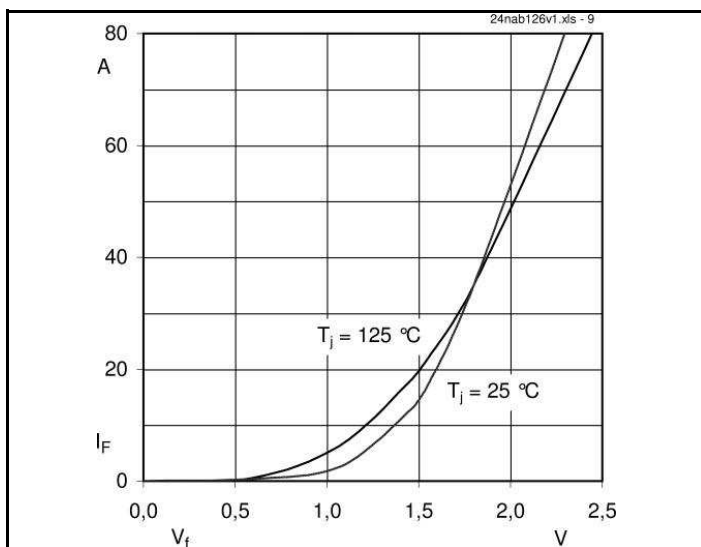

Fig. 9 Typ. freewheeling diode forward characteristic

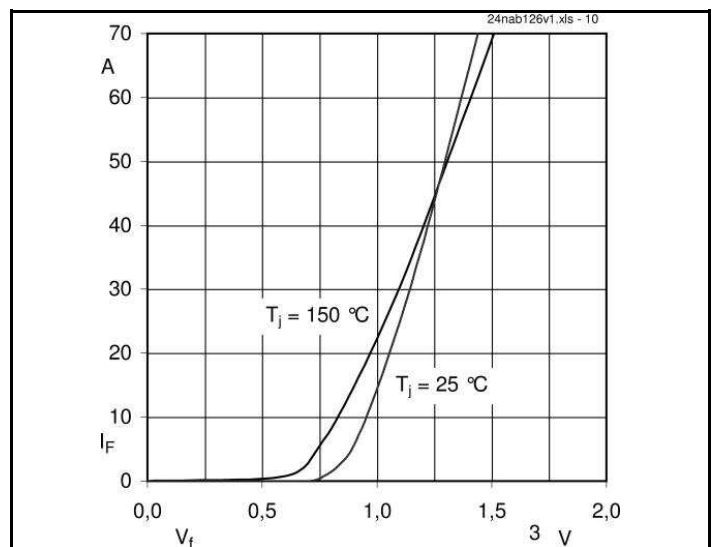
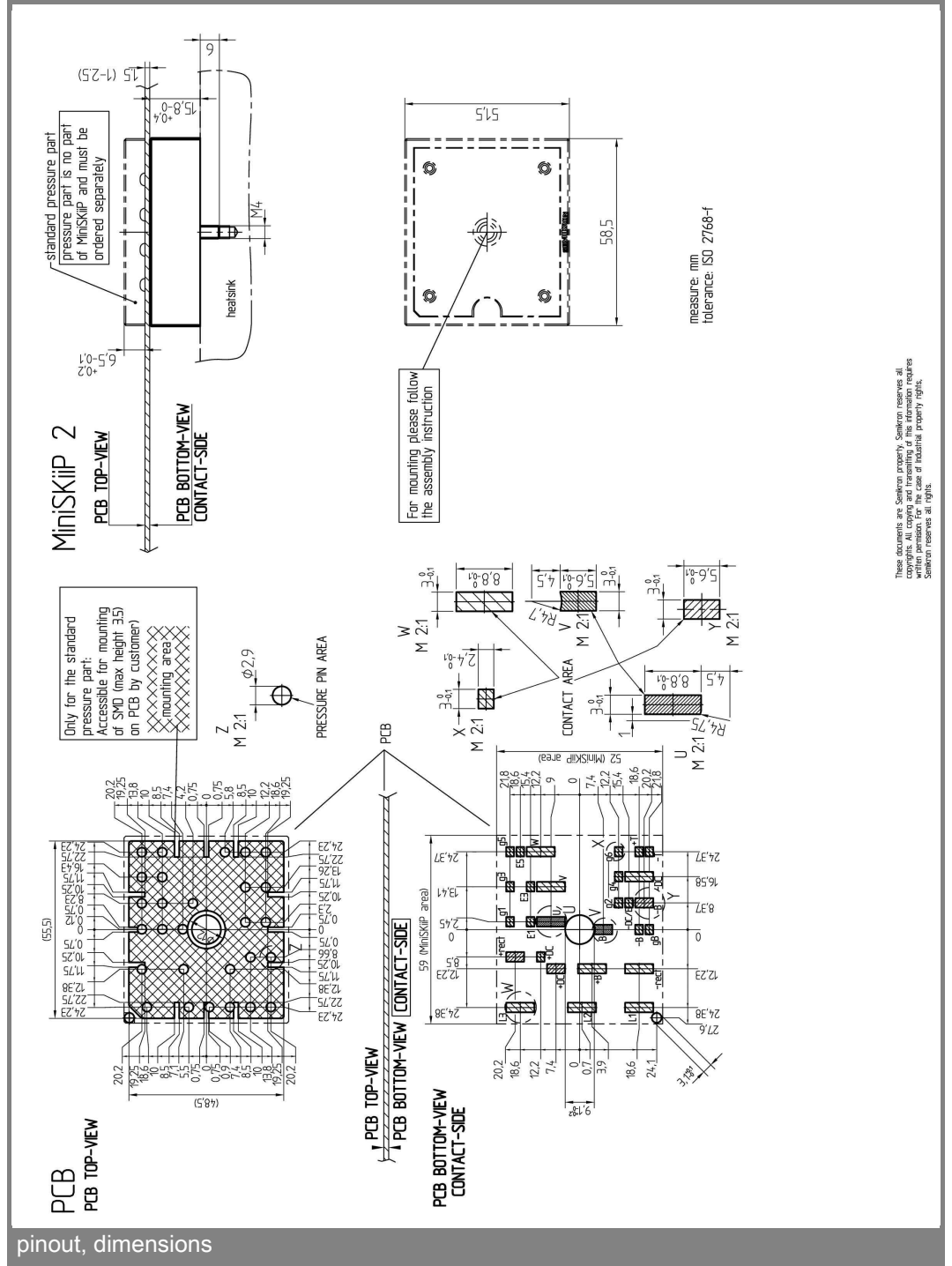
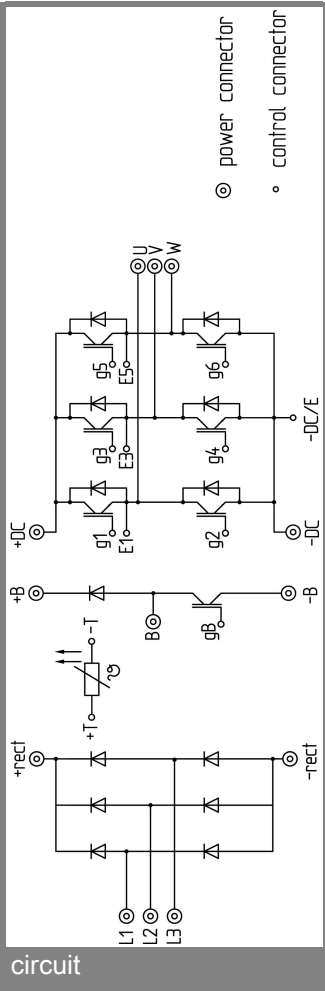

Fig. 10 Typ. input bridge forward characteristic



These documents are Semikron property. Semikron reserves all copyrights. All copying and transmitting of this information requires written permission for the case of industrial property rights. Semikron reserved all rights.

This is an electrostatic discharge sensitive device (ESDS), international standard IEC 60747-1, Chapter IX.

* The specifications of our components may not be considered as an assurance of component characteristics. Components have to be tested for the respective application. Adjustments may be necessary. The use of SEMIKRON products in life support appliances and systems is subject to prior specification and written approval by SEMIKRON. We therefore strongly recommend prior consultation of our personal.