

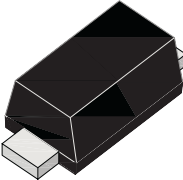



2.0 Amp. Surface Mount Schottky Barrier Rectifier

<p>SOD123W</p> 	<p>Voltage 20 V to 200V</p>	<p>Current 2.0 A</p>	
	<p>FEATURES</p> <ul style="list-style-type: none"> • Low profile package • Ideal for automated placement • Guardring for overvoltage protection • Low power losses, high efficiency • Low forward voltage drop • High forward surge current capability • Solder dip 260°C, 10s • AEC-Q101 qualified • Component in accordance to RoHS 2011/65/EU and WEEE 2002/96/EC • Meets MSL level 1, per J-STD-020, LF maximum peak of 260° C • Low leakage current 		   RoHS COMPLIANT
	<p>MECHANICAL DATA</p> <ul style="list-style-type: none"> • Case: SOD123W. Epoxy meets UL 94V-0 flammability rating. • Polarity: Color band denotes cathode end. • Terminals: Matte tin plated leads, solderable per MIL-STD-750 Method 2026, J-STD-002 and JESD22-B102. Consumer grade, meets JESD 201 class 1A whisker test. • HE3 suffix for high reliability grade, meets JESD 201 class 2 whisker test. 		
	<p>TYPICAL APPLICATIONS</p> <p>Used in low voltage high frequency inverters, freewheeling, dc-to-dc converters, and polarity protection applications.</p>		

Maximum Ratings and Electrical Characteristics at 25°C

		FSS22W	FSS23W	FSS24W	FSS26W	FSS210W	FSS215W	FSS220W
Marking code		2D	2E	2F	2G	2H	2I	2J
V _{RRM}	Maximum Recurrent Peak Reverse Voltage (V)	20	30	40	60	100	150	200
V _{RMS}	Maximum RMS Voltage (V)	14	21	28	42	70	105	140
V _{DC}	Maximum DC Blocking Voltage (V)	20	30	40	60	100	150	200
I _{F(AV)}	Forward Current at T _c (See graphic)	2.0 A						
I _{FSM}	8.3 ms. Peak Forward Surge Current (Jedec Method)	50 A						
T _j	Operating Temperature Range	-65°C to +125°C			-65°C to +150°C			
T _{stg}	Storage Temperature Range	-65°C to +150°C						

Electrical Characteristics at Tamb = 25 °C

V _F	Maximum Instantaneous Forward Voltage I _F = 2.0 A (Note 1)	0.5 V	0.70 V	0.85 V	0.95 V
I _R	Maximum DC Reverse Current T _j = 25 °C at Rated DC Blocking Voltage T _j = 125°C (Note 3)	0.4 mA		0.1 mA	
C _j	Typical Junction Capacitance	130 pF			
R _{th(j-c)} R _{th(j-a)}	Typical Thermal Resistance (Note 2)	17 °C/W		75 °C/W	

Notes: 1. Pulse Test: 300µ Pulse Width, 1% Duty Cycle
 2. Thermal Resistance from Junction to Case per diode
 3. Pulse test: Pulse width ≤ 40ms

2.0 Amp. Surface Mount Schottky Barrier Rectifier

Ordering information

PREFERRED P/N	PACKAGE CODE	DELIVERY MODE	BASE QUANTITY	UNIT WEIGHT (g)
FSS24W TRTB	TRTB	13" diameter tape and reel	10,000	0.0165
FSS24W HE3 TRTB	TRTB	13" diameter tape and reel	10,000	0.0165

Package Outline Dimensions: (mm) SOD123W

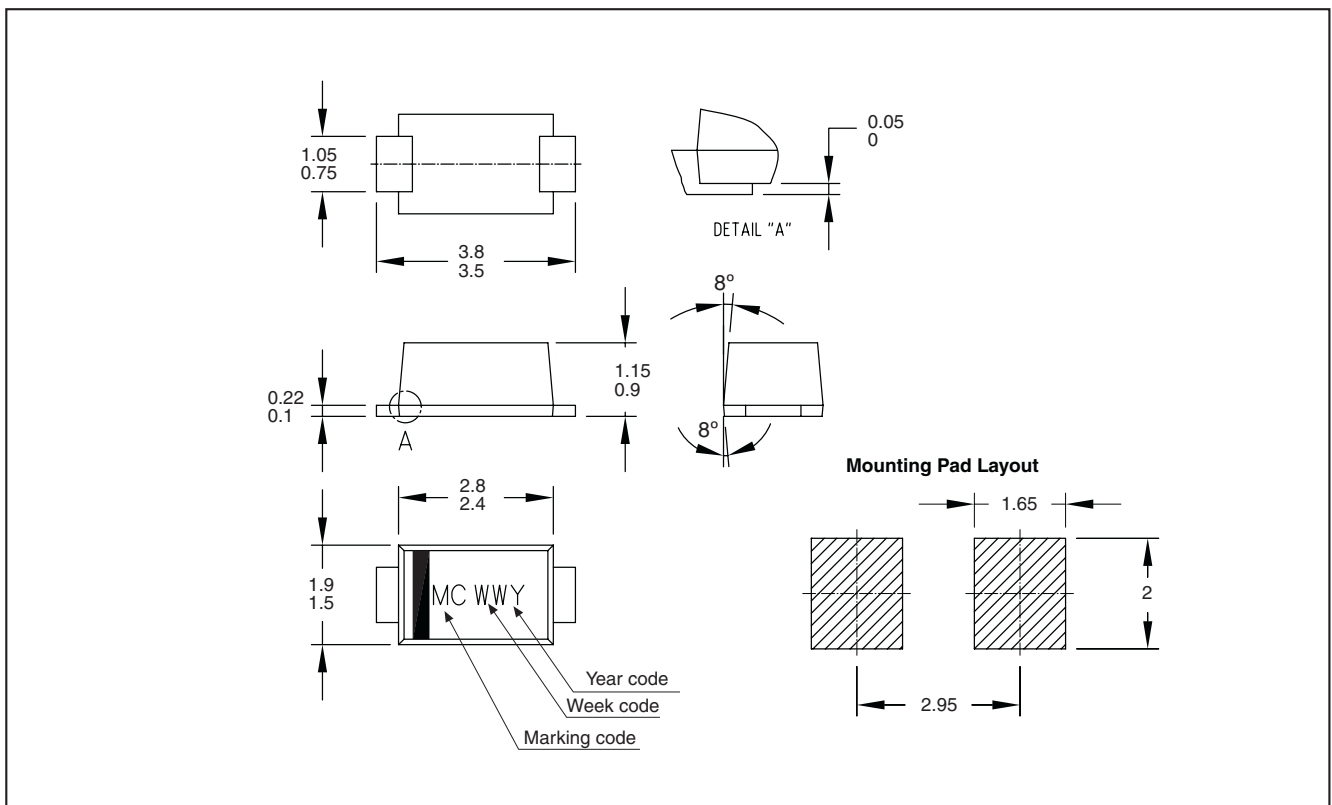

2.0 Amp. Surface Mount Schottky Barrier Rectifier

Ratings and Characteristics (Ta 25 °C unless otherwise noted)

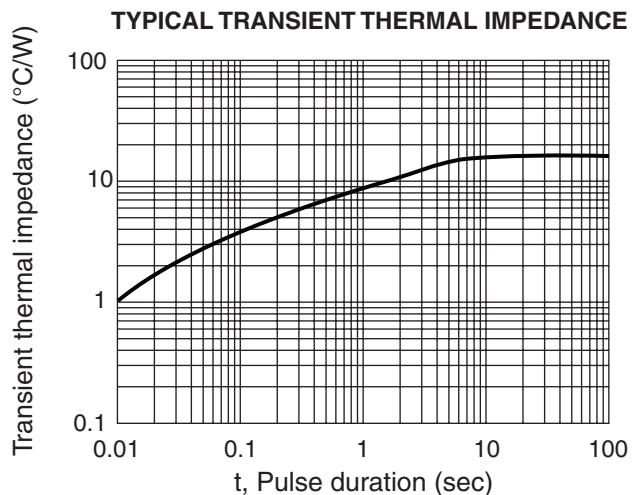
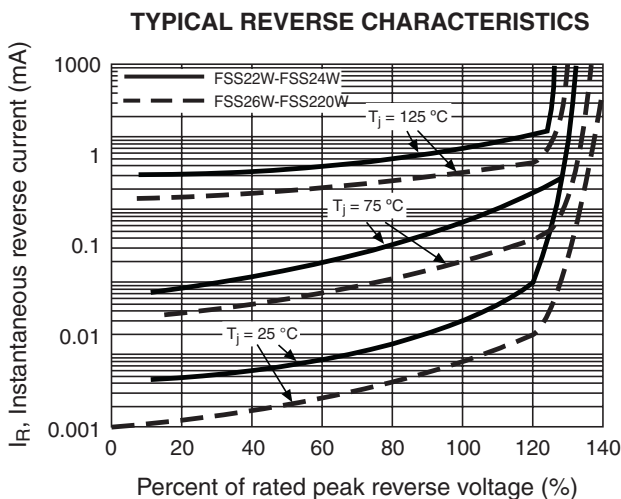
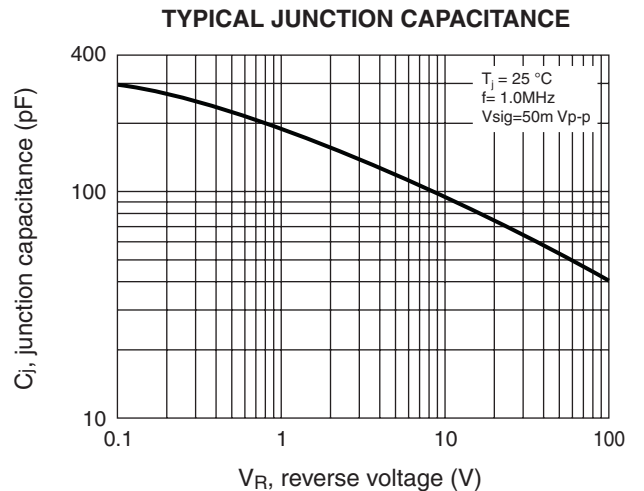
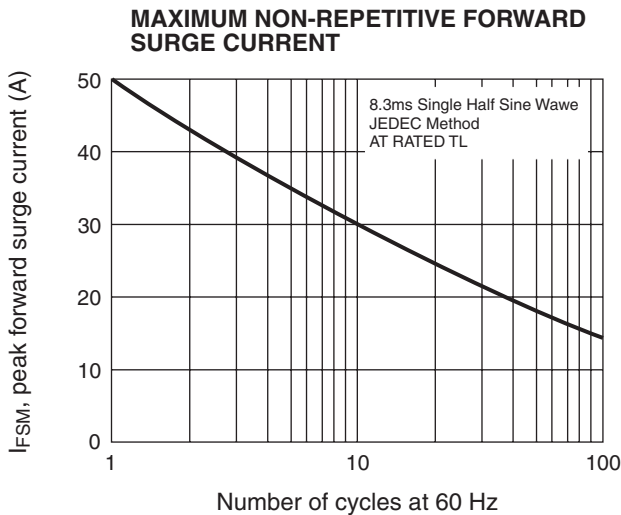
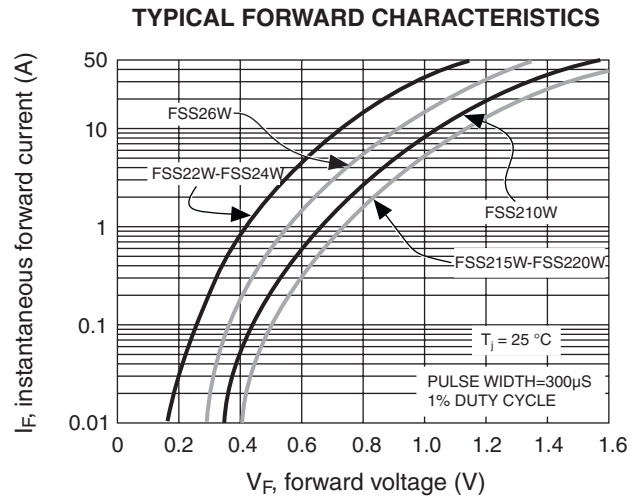
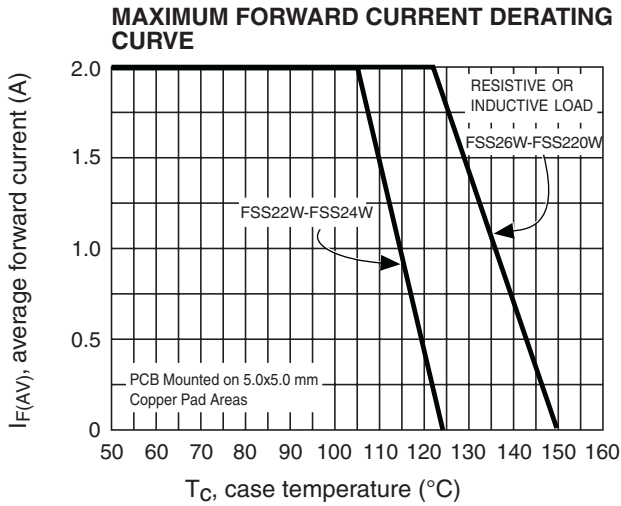

2.0 Amp. Surface Mount Schottky Barrier Rectifier**Disclaimer**

All product, product specifications and data are subject to change without notice to improve reliability, function or design or otherwise.

Fagor Electrónica, S.Coop., its affiliates, agents, and employees, and all persons acting on its or their behalf (collectively, "Fagor"), disclaim any and all liability for any errors, inaccuracies or incompleteness contained in any datasheet or in any other disclosure relating to any product.

Fagor makes no warranty, representation or guarantee regarding the suitability of the products for any particular purpose or the continuing production of any product. To the maximum extent permitted by applicable law, Fagor disclaims (i) any and all liability arising out of the application or use of any product, (ii) any and all liability, including without limitation special, consequential or incidental damages, and (iii) any and all implied warranties, including warranties of fitness for particular purpose, non-infringement and merchantability.

Statements regarding the suitability of products for certain types of applications are based on Fagor's knowledge of typical requirements that are often placed on Fagor products in generic applications. Such statements are not binding statements about the suitability of products for a particular application. It is the customer's responsibility to validate that a particular product with the properties described in the product specification is suitable for use in a particular application. Parameters provided in datasheets and/or specifications may vary in different applications and performance may vary over time. All operating parameters, including typical parameters, must be validated for each customer application by the customer's technical experts. Product specifications do not expand or otherwise modify Fagor's terms and conditions of purchase, including but not limited to the warranty expressed therein.

Except as expressly indicated in writing, Fagor products are not designed for use in medical, life-saving, or life-sustaining applications or for any other application in which the failure of the Fagor product could result in personal injury or death. Customers using or selling Fagor products not expressly indicated for use in such applications do so at their own risk and agree to fully indemnify and hold Fagor and its distributors harmless from and against any and all claims, liabilities, expenses and damages arising or resulting in connection with such use or sale, including attorneys fees, even if such claim alleges that Fagor or its distributor was negligent regarding the design or manufacture of the part. Please contact authorized Fagor personnel to obtain written terms and conditions regarding products designed for such applications.

No license, express or implied, by estoppel or otherwise, to any intellectual property rights is granted by this document or by any conduct of Fagor, Product names and markings noted herein may be trademarks of their respective owners.