

1.5 Amp. Surface Mount Glass Passivated Rectifier

<p>DO-214AA (SMB)</p> 	<p>Voltage 50 V to 1000 V</p> <p>Current 1.5 A</p> <p style="color: red; font-weight: bold; text-align: center;">HYPERRECTIFIER®</p>
	<p>FEATURES</p> <ul style="list-style-type: none"> Low profile package Ideal for automated placement Low power losses, high efficiency High surge current capability Cavity-free glass-passivated junction Low forward voltage drop Solder dip 260°C, 10s AEC-Q101 qualified Component in accordance to RoHS 2011/65/EC and WEEE 2002/96/EC Meets MSL level 1, per J-STD-020, LF maximum peak of 260° C
	<p>MECHANICAL DATA</p> <ul style="list-style-type: none"> Case: DO-214AA (SMB). Epoxy meets UL 94V-0 flammability rating. Polarity: Color band denotes cathode end. Terminals: Matte tin plated leads, solderable per MIL-STD-750 Method 2026, J-STD-002 and JESD22-B102. Consumer grade, meets JESD 201 class 1A whisker test
	<p>TYPICAL APPLICATIONS</p> <p>Used in general purpose rectification of power supplies, inverters, converters and freewheeling diodes application.</p>



Maximum Ratings and Electrical Characteristics at 25 °C

		FS2A	FS2B	FS2D	FS2G	FS2J	FS2K	FS2M
Marking Code		S1	S2	S3	S4	S5	S6	S7
Halogen Free Marking Code		1K	1L	1M	1N	1P	1Q	1R
V_{RRM}	Maximum Recurrent Peak Reverse Voltage (V)	50	100	200	400	600	800	1000
V_{RMS}	Maximum RMS Voltage (V)	35	70	140	280	420	560	700
V_{DC}	Maximum DC Blocking Voltage (V)	50	100	200	400	600	800	1000
$I_{F(AV)}$	Forward Current @ $T_C = 100\text{ °C}$	1.5 A						
I_{FSM}	8.3 ms. peak forward surge current (Jedec Method)	50 A						
V_F	Maximum Instantaneous Forward Voltage @ 1.5A	1.10 V						
I_R	Maximum DC Reverse Current @ $T_c = 25\text{ °C}$ at Rated DC Blocking Voltage @ $T_c = 125\text{ °C}$	1 μ A 125 μ A						
t_{rr}	Typical Reverse Recovery Time (0.5/1/0.25A)	4 μ s						
C_j	Typical Junction Capacitance (1MHz; -4V)	30 pF						
$R_{th(j-c)}$	Typical Thermal Resistance	20 °C/W						
$R_{th(j-a)}$	(5x5 mm ² x 130 μ Copper Area)	60 °C/W						
$T_j - T_{stg}$	Operating Junction and Storage Temperature Range	-55 to + 150 °C						

1.5 Amp. Surface Mount Glass Passivated Rectifier

Ordering information

PREFERRED P/N	PACKAGE CODE	DELIVERY MODE	BASE QUANTITY	UNIT WEIGHT (g)
FS2M TRTB	TRTB	13" diameter tape and reel	3,000	0.0823
FS2M HF TRTB	TRTB	13" diameter tape and reel	3,000	0.0823

Package Outline Dimensions: (mm) DO-214AA (SMB)

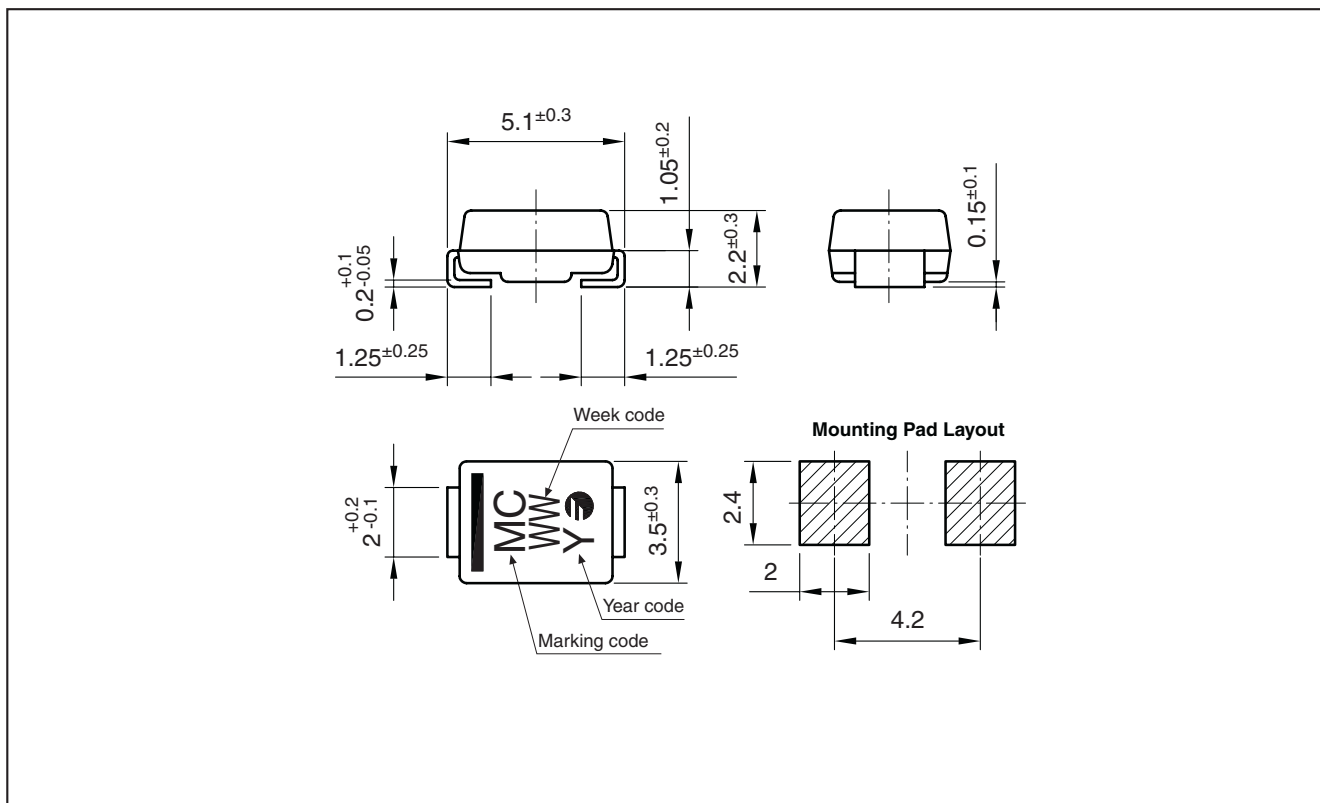

1.5 Amp. Surface Mount Glass Passivated Rectifier

Ratings and Characteristics (Ta 25 °C unless otherwise noted)

FORWARD CURRENT DERATING CURVE

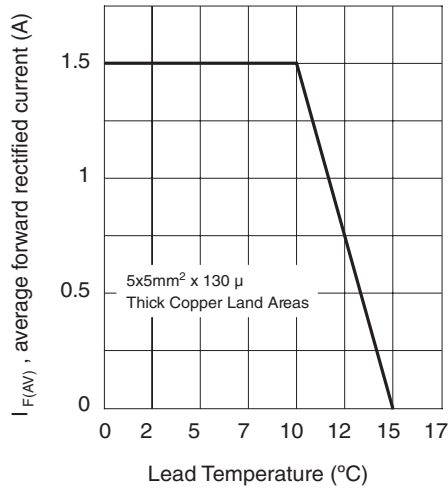

TYPICAL FORWARD CHARACTERISTIC

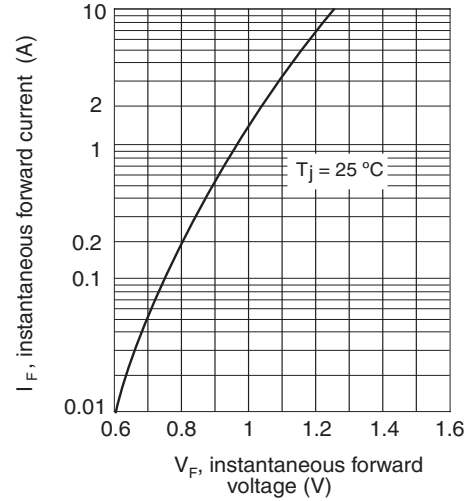

MAXIMUM NON REPETITIVE PEAK FORWARD SURGE CURRENT

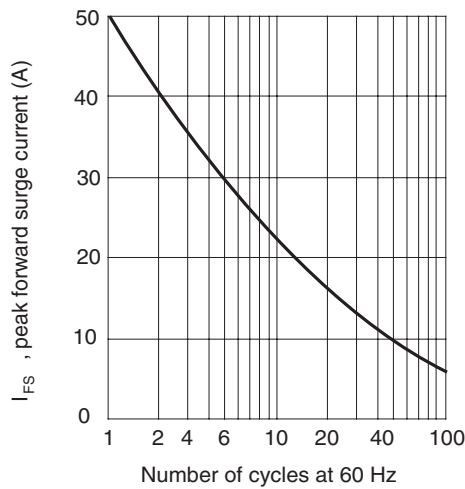

TYPICAL REVERSE CHARACTERISTIC

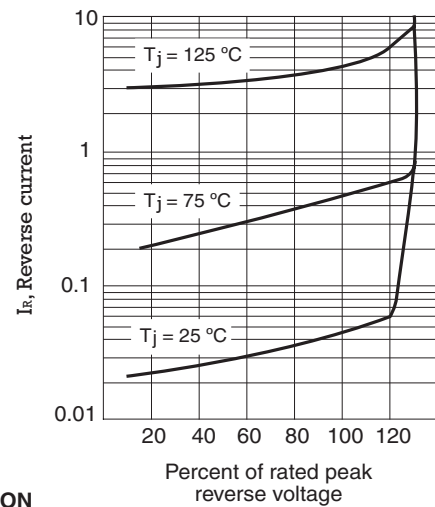

TYPICAL JUNCTION CAPACITANCE

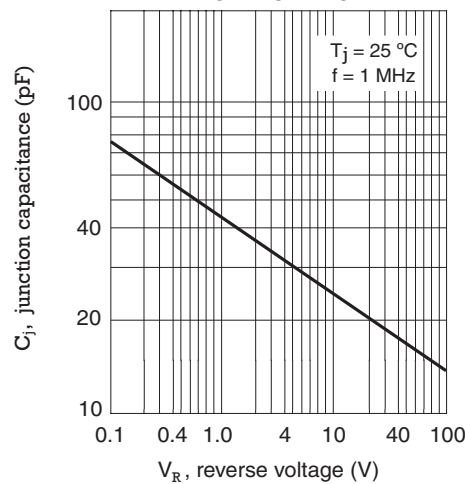

1.5 Amp. Surface Mount Glass Passivated Rectifier

Disclaimer

All product, product specifications and data are subject to change without notice to improve reliability, function or design or otherwise.

Fagor Electrónica, S.Coop., its affiliates, agents, and employees, and all persons acting on its or their behalf (collectively, "Fagor"), disclaim any and all liability for any errors, inaccuracies or incompleteness contained in any datasheet or in any other disclosure relating to any product.

Fagor makes no warranty, representation or guarantee regarding the suitability of the products for any particular purpose or the continuing production of any product. To the maximum extent permitted by applicable law, Fagor disclaims (i) any and all liability arising out of the application or use of any product, (ii) any and all liability, including without limitation special, consequential or incidental damages, and (iii) any and all implied warranties, including warranties of fitness for particular purpose, non-infringement and merchantability.

Statements regarding the suitability of products for certain types of applications are based on Fagor's knowledge of typical requirements that are often placed on Fagor products in generic applications. Such statements are not binding statements about the suitability of products for a particular application. It is the customer's responsibility to validate that a particular product with the properties described in the product specification is suitable for use in a particular application. Parameters provided in datasheets and/or specifications may vary in different applications and performance may vary over time. All operating parameters, including typical parameters, must be validated for each customer application by the customer's technical experts. Product specifications do not expand or otherwise modify Fagor's terms and conditions of purchase, including but not limited to the warranty expressed therein.

Except as expressly indicated in writing, Fagor products are not designed for use in medical, life-saving, or life-sustaining applications or for any other application in which the failure of the Fagor product could result in personal injury or death. Customers using or selling Fagor products not expressly indicated for use in such applications do so at their own risk and agree to fully indemnify and hold Fagor and its distributors harmless from and against any and all claims, liabilities, expenses and damages arising or resulting in connection with such use or sale, including attorneys fees, even if such claim alleges that Fagor or its distributor was negligent regarding the design or manufacture of the part. Please contact authorized Fagor personnel to obtain written terms and conditions regarding products designed for such applications.

No license, express or implied, by estoppel or otherwise, to any intellectual property rights is granted by this document or by any conduct of Fagor, Product names and markings noted herein may be trademarks of their respective owners.