

D2FD

Dust Proof Ultra Subminiature Basic Switch

Ultra subminiature and dust proof

- Sealing by using rubber packing means the switch can be used in dust-proof environments (IEC IP6X).
- Switch rating of 2 A at 125 VAC possible with a single-leaf movable spring. Models for micro loads are also available.
- Solder and PCB terminals are available.

RoHS Compliant



NEW

Model Number Legend

D2FD- -1

1. Rating

- 2 : 2 A at 125 VAC / 30 VDC
- 01 : 0.1 A at 125 VAC / 30 VDC



2. Actuator

- L0 : Pin plunger
- L1 : Hinge lever
- L30 : Simulated roller lever

3. Terminals

- H : Solder terminals
- T : PCB terminals

List of Models

| Actuator | Terminals | Ratings | |
|--|------------------|--------------|---------------|
| | | 2 A | 0.1 A |
| Pin plunger  | Solder terminals | D2FD-2L0-1H | D2FD-01L0-1H |
| | PCB terminals | D2FD-2L0-1T | D2FD-01L0-1T |
| Hinge lever  | Solder terminals | D2FD-2L1-1H | D2FD-01L1-1H |
| | PCB terminals | D2FD-2L1-1T | D2FD-01L1-1T |
| Simulated roller lever (R2.5)  | Solder terminals | D2FD-2L30-1H | D2FD-01L30-1H |
| | PCB terminals | D2FD-2L30-1T | D2FD-01L30-1T |

Contact Form

- SPDT

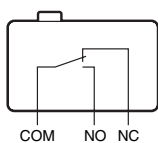

Contact Specifications

| Item | Model | D2FD-2 models | D2FD-01 models |
|------------------------------------|----------------------|-----------------|----------------|
| Contact | Specification | Crossbar | |
| | Material | Silver alloy | Gold alloy |
| | Gap (standard value) | 0.25 mm | |
| Minimum applicable load (see note) | | 100 mA at 5 VDC | 1 mA at 5 VDC |

Note: For more information on the minimum applicable load, refer to *Using Micro Loads*.

Ratings

| Rated voltage | Model | D2FD-2 models | D2FD-01 models |
|---------------|-------|----------------|----------------|
| | | Resistive load | |
| 125 VAC | | 2 A | 0.1 A |
| 30 VDC | | 2 A | 0.1 A |

Note: The rating values apply under the following test conditions.

1. Ambient temperature: $20 \pm 2^\circ\text{C}$
2. Ambient humidity: $65 \pm 5\%$
3. Operating frequency: 20 operations/min

Characteristics

| Item | Model | D2FD-2 models | D2FD-01 models |
|------------------------------------|-------------|--|---|
| Operating speed | | 1 mm to 500 mm/s | |
| Operating frequency | Mechanical | 120 operations/min max. | |
| | Electrical | 20 operations/min max | |
| Insulation resistance | | 100 M Ω min. (at 500 VDC) | |
| Contact resistance (initial value) | | 30 m Ω max. | 100 m Ω max. |
| Dielectric strength (see note 2) | | 600 VAC 50/60 Hz 1 min between terminals of same polarity | |
| | | 1,500 VAC 50/60 Hz 1 min between current carrying metal parts and ground | |
| | | 1,500 VAC 50/60 Hz 1 min between each terminal and non-current carrying metal part | |
| Vibration resistance (see note 3) | Malfunction | 10 to 55 Hz, 1.5 mm double amplitude | |
| Shock resistance (see note 3) | Destruction | 1,000 m/s ² max. | |
| | Malfunction | 300 m/s ² max. | |
| Durability (see note 4) | Mechanical | 300,000 operations min. (at 60 ops./min.) | |
| | Electrical | 30,000 operations min. (at 20 ops./min.) | 100,000 operations min. (at 20 ops./min.) |
| Degree of protection | | IP6X | |
| Ambient operating temperature | | -20 to $+70^\circ\text{C}$ (at 60%RH max.) (with no icing) | |
| Ambient operation humidity | | 85%RH max. (for $+5$ to $+35^\circ\text{C}$) | |
| Weight | | Approx. 0.7 g (pin plunger, PCB terminal models) | |

Note: 1. The data given above are initial values.

2. The dielectric strength shown in the table indicates a value for models with a Separator.

3. For the pin plunger models, the above values apply for both the free position and total travel position. For the lever models, the values apply at the total travel position. Contact opening or closing time is within 1 ms.

4. Consult your OMRON sales representative for testing conditions.

Terminals (Unit: mm)

● Solder Terminals

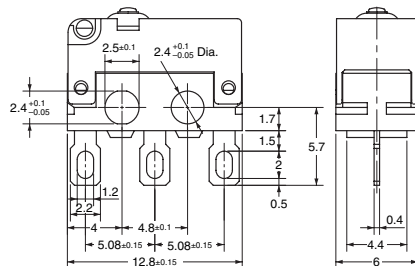

● PCB Terminals

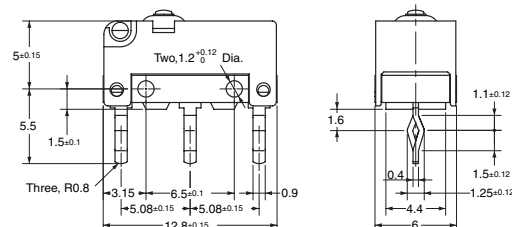

PCB Mounting Dimensions (Reference)

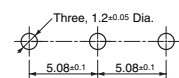

Mounting Holes (Unit: mm)

● Solder Terminals

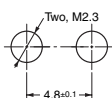

Dimensions (Unit: mm) / Operating Characteristics

The following illustrations and drawings are for solder terminal models. PCB terminal models are omitted from the drawings. Refer to *Terminals* for these terminals. When ordering, replace □ with the code for the rating that you need. For the combination of models, refer to *List of Models*.

● Pin Plunger Models

D2FD-□L0-1H

D2FD-□L0-1T

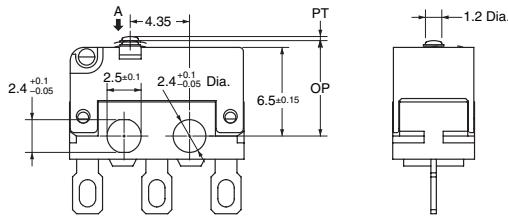

| Model | D2FD-□L0-1H D2FD-□L0-1T |
|----------|----------------------------|
| OF max. | 2.00 N {204 gf} |
| RF min. | 0.25 N {25 gf} |
| PT max. | 0.6 mm |
| OT mix. | 0.25 mm |
| MD max. | 0.12 mm |
| OP (-1H) | 7.0 ± 0.2 mm |
| OP (-1T) | 7.0 ± 0.3 mm |

● Hinge Lever Models

D2FD-□L1-1H

D2FD-□L1-1T

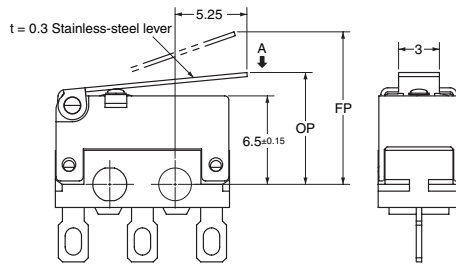

| Model | D2FD-□L1-1H D2FD-□L1-1T |
|----------|----------------------------|
| OF max. | 0.65 N {66 gf} |
| RF min. | 0.05 N {5 gf} |
| OT mix. | 0.5 mm |
| MD max. | 0.5 mm |
| FP max. | 11.3 mm |
| OP (-1H) | 8.3 ± 1.0 mm |
| OP (-1T) | 8.3 ± 1.2 mm |

● Simulated Roller Lever Models (R2.5)

D2FD-□L30-1H

D2FD-□L30-1T

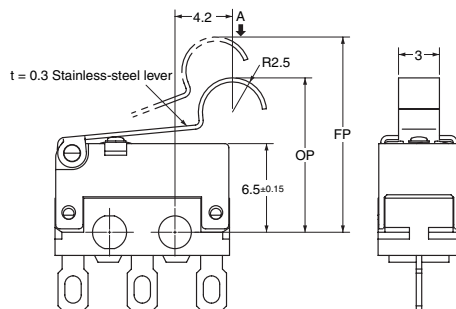

| Model | D2FD-□L30-1H D2FD-□L30-1T |
|----------|------------------------------|
| OF max. | 0.65 N {66 gf} |
| RF min. | 0.05 N {5 gf} |
| OT mix. | 0.5 mm |
| MD max. | 0.5 mm |
| FP max. | 14.3 mm |
| OP (-1H) | 11.3 ± 1.0 mm |
| OP (-1T) | 11.3 ± 1.2 mm |

Note: 1. Unless otherwise specified, a tolerance of ±0.4 mm applies to all dimensions.
2. The operating characteristics are for operation in the A direction (↓).

Precautions

★ Refer to General Information.

Cautions

● Degree of Protection

- Do not use the Switch under the environment where it is exposed to water.
The degree of protection is IP6X and the protection against water is not defined.
- Prevent the Switch from coming into contact with oil and chemicals. Otherwise, damage to or deterioration of Switch materials may result.
- Do not use the Switch in areas where it is exposed to silicon adhesives, oil, or grease, otherwise faulty contact may result due to the generation of silicon oxide.
- The environment-resistant performance of the switch differs depending on operating loads, ambient atmospheres, and installation conditions, etc. Please perform an operating test of the switch in advance under actual usage conditions.

● Terminal Connection

- When soldering a lead wire to the terminal, first insert the lead wire conductor into the terminal hole and then perform soldering. Make sure that the capacity of the soldering iron is 30 W maximum and that the temperature of the soldering iron tip is approximately 300°C. (350°C maximum.) Complete the soldering within 3 s.
Using a switch with improper soldering may result in abnormal heating, possibly resulting in burn.
Applying a soldering iron for more than 3 s or using one that is rated at more than 30 W may deteriorate the switch characteristics.
When using automatic soldering baths, we recommend soldering at $260 \pm 5^\circ\text{C}$ within 5 seconds. Make sure that the liquid surface of the solder does not flow over the edge of the board.

Correct Use

● Mounting

- Turn OFF the power supply before mounting or removing the Switch, wiring, or performing maintenance or inspection. Failure to do so may result in electric shock or burning.
- Use M2.3 mounting screws with plane washers or spring washers to securely mount the Switch. Tighten the screws to a torque of 0.20 to 0.29 N·m {2.0 to 2.9 kgf·cm}. Exceeding the specified torque may result in deterioration of the sealing or damage. Mount the Switch onto a flat surface. Mounting on an uneven surface may cause deformation of the Switch, resulting in faulty operation or damage.

● Operating Body

- Use an operating body with low frictional resistance and of a shape that will not interfere with the sealing rubber, otherwise the plunger may be damaged or the sealing may deteriorate. With the pin plunger models, set the Switch so that the plunger can be pushed in from directly above. Since the plunger is covered with a rubber cap, applying a force from lateral directions may cause damage to the plunger or reduction in the sealing capability.

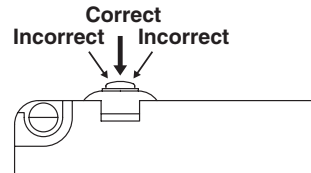

● Handling

- Do not handle the Switch in a way that may cause damage to the sealing rubber.
- When handling the Switch, ensure that uneven pressure or, as shown in the following diagram, pressure in a direction other than the operating direction is not applied to the Actuator, otherwise the Actuator or Switch may be damaged, or durability may be decreased.

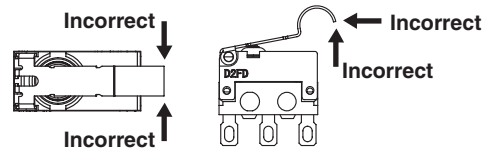

● Using Micro Loads

Using a model for ordinary loads to open or close the contact of a micro load circuit may result in faulty contact. Use models that operate in the following range. However, even when using micro load models within the operating range shown below, if inrush current occurs when the contact is opened or closed, it may increase contact wear and so decrease durability. Therefore, insert a contact protection circuit where necessary. The minimum applicable load is the N-level reference value. This value indicates the malfunction reference level for the reliability level of 60% ($\lambda 60$). The equation, $\lambda 60 = 0.5 \times 10^{-6}/\text{operations}$ indicates that the estimated malfunction rate is less than 1/2,000,000 operations with a reliability level of 60%.

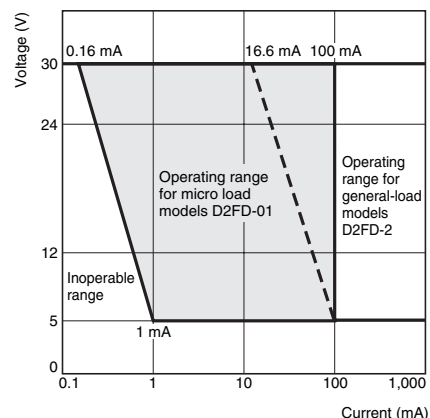

ALL DIMENSIONS SHOWN ARE IN MILLIMETERS.

To convert millimeters into inches, multiply by 0.03937. To convert grams into ounces, multiply by 0.03527.

- Application examples provided in this document are for reference only. In actual applications, confirm equipment functions and safety before using the product.
- Consult your OMRON representative before using the product under conditions which are not described in the manual or applying the product to nuclear control systems, railroad systems, aviation systems, vehicles, combustion systems, medical equipment, amusement machines, safety equipment, and other systems or equipment that may have a serious influence on lives and property if used improperly. Make sure that the ratings and performance characteristics of the product provide a margin of safety for the system or equipment, and be sure to provide the system or equipment with double safety mechanisms.

Note: Do not use this document to operate the Unit.

OMRON Corporation Electronic and Mechanical Components Company

Contact: www.omron.com/ecb

OMRON ELECTRONIC COMPONENTS EUROPE B.V.
Wegalaan 57, 2132 JD Hoofddorp, THE NETHER LANDS
Tel: (31)23-568-1200/Fax: 31-23-568-1212

OMRON ELECTRONIC COMPONENTS LLC
55 East Commerce Drive, Suite B, IL 60173 U.S.A.
Tel: (1)847-882-2288/Fax: 1-847-882-2192

OMRON ELECTRONIC COMPONENTS PTE LTD.
438A Alexandra Road #05-05/08 Alexandra
Technopark Singapore 119967
TEL:(65)6376-3200/FAX:(65)6376-3211

**OMRON ELECTRONIC COMPONENTS TRADING
(SHANGHAI) LTD. SHANGHAI OFFICE**
27F Xin Mei Union Square, 999 Pudong South Road,
Pudong New Area, Shanghai, CHINA 200120
Tel: (86)21-6859-5919/Fax: 86-21-6859-5911

OMRON ELECTRONIC COMPONENTS CO., LTD.
14F, Daegong Bldg. #823-21, Yeoksam-dong,
Gangnam-gu, Seoul, Korea, 135-080
Tel:(82)2-567-5020/Fax:(82)2-567-5804

Authorized Distributor:

© OMRON Corporation 2012 All Rights Reserved.
In the interest of product improvement,
specifications are subject to change without notice.

Cat. No. B119-E1-01

0312