

### FEATURES

- High Output Power:  $P_{1dB} = 39.5\text{dBm}$  (Typ.)
- High Gain:  $G_{1dB} = 10.0\text{dB}$  (Typ.)
- High PAE:  $\eta_{add} = 36\%$  (Typ.)
- Low IM3 =  $-46\text{dBc}@P_o = 28.5\text{dBm}$
- Broad Band: 4.4 to 5.0GHz
- Impedance Matched  $Z_{in}/Z_{out} = 50\text{ohm}$
- Hermetically Sealed Package

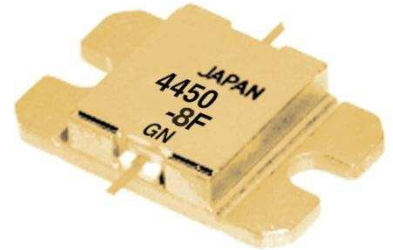

### DESCRIPTION

The FLM4450-8F is a power GaAs FET that is internally matched for standard communication bands to provide optimum power and gain in a 50 ohm system.

SEDI's stringent Quality Assurance Program assures the highest reliability and consistent performance.

### ABSOLUTE MAXIMUM RATING (Ambient Temperature $T_a=25\text{deg.C}$ )

Item	Symbol	Condition	Rating	Unit
Drain-Source Voltage	$V_{DS}$		15	V
Gate-Source Voltage	$V_{GS}$		-5	V
Total Power Dissipation	$P_T$	$T_c = 25\text{deg.C}$	42.8	W
Storage Temperature	$T_{stg}$		-65 to +175	deg.C
Channel Temperature	$T_{ch}$		175	deg.C

SEDI recommends the following conditions for the reliable operation of GaAs FETs:

1. The drain-source operating voltage ( $V_{DS}$ ) should not exceed 10 volts.
2. The forward and reverse gate currents should not exceed 32.0 and -4.4 mA respectively with gate resistance of 100ohm.

### ELECTRICAL CHARACTERISTICS (Ambient Temperature $T_a=25\text{deg.C}$ )

Item	Symbol	Test Conditions	Limit			Unit
			Min.	Typ.	Max.	
Saturated Drain Current	$I_{DSS}$	$V_{DS}=5V, V_{GS}=0V$	-	3900	5850	mA
Transconductance	$g_m$	$V_{DS}=5V, I_{DS}=2200\text{mA}$	-	2000	-	mS
Pinch-off Voltage	$V_p$	$V_{DS}=5V, I_{DS}=180\text{mA}$	-1.0	-2.0	-3.5	V
Gate Source Breakdown Voltage	$V_{GSO}$	$I_{GS}=-180\text{uA}$	-5.0	-	-	V
Output Power at 1dB G.C.P.	$P_{1dB}$	$V_{DS}=10V,$	38.5	39.5	-	dBm
Power Gain at 1dB G.C.P.	$G_{1dB}$	$I_{DS}=0.55 I_{DSS}$ (Typ.),	9.0	10.0	-	dB
Drain Current	$I_{dsr}$	$f=4.4$ to $5.0$ GHz,	-	2200	2600	mA
Power-added Efficiency	$\eta_{add}$	$Z_S=Z_L=50\text{ohm}$	-	36	-	%
Gain Flatness	$\Delta G$		-	-	+/-0.6	dB
3rd Order Intermodulation Distortion	$IM_3$	$f = 5.0$ GHz, $\Delta f = 10$ MHz 2-Tone Test $P_{out} = 28.5\text{dBm}$ S.C.L.	-44	-46	-	dBc
Thermal Resistance	$R_{th}$	Channel to Case	-	3.0	3.5	deg.C/W
Channel Temperature Rise	$\Delta T_{ch}$	$10V \times I_{dsr} \times R_{th}$	-	-	80	deg.C

G.C.P.: Gain Compression Point, S.C.L.: Single Carrier Level

<b>CASE STYLE</b>	<b>IB</b>
<b>ESD</b>	<b>Class 3A</b>
	<b>4000V to 8000V</b>
Note : Based on EIAJ ED-4701 C-111A (C=100pF, R=1.5kohm)	
<b>RoHS Compliance</b>	<b>Yes</b>

**POWER DERATING CURVE**

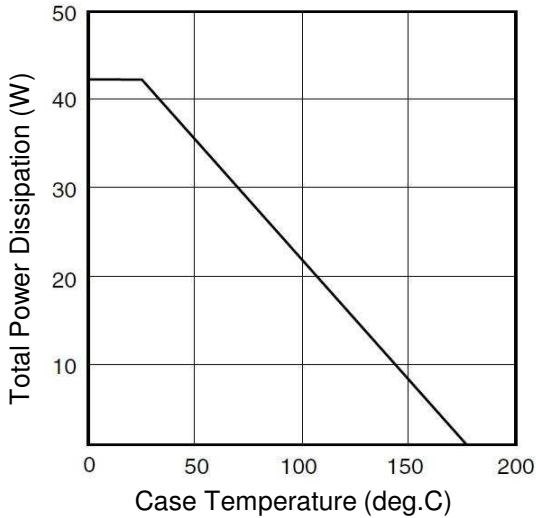

**OUTPUT POWER & IM<sub>3</sub> vs. INPUT POWER**

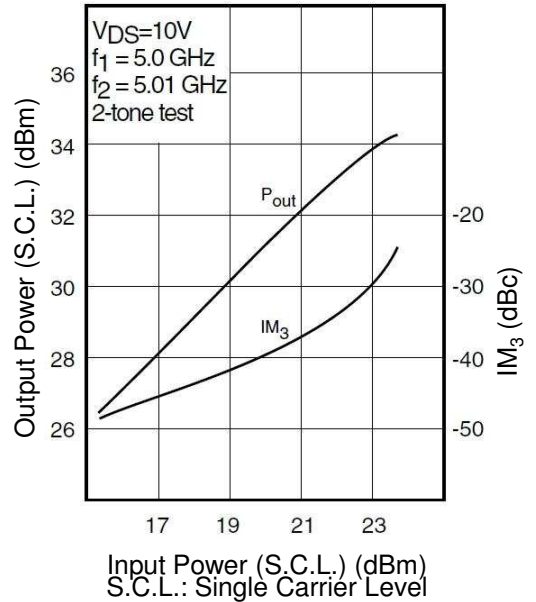

**OUTPUT POWER vs. FREQUENCY**

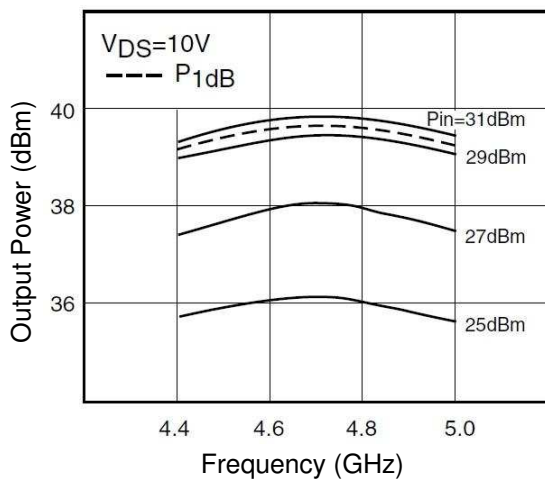

**OUTPUT POWER vs. INPUT POWER**

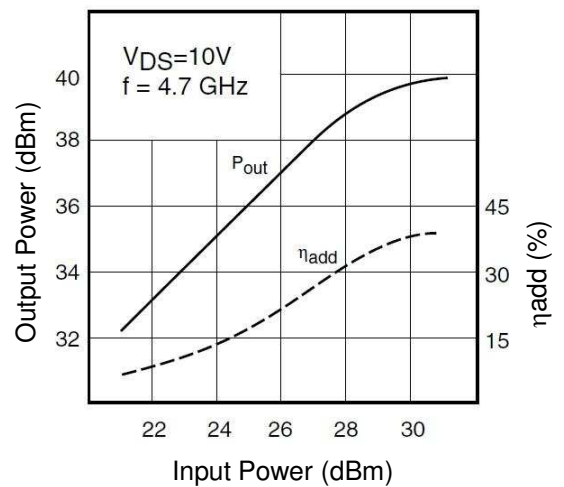

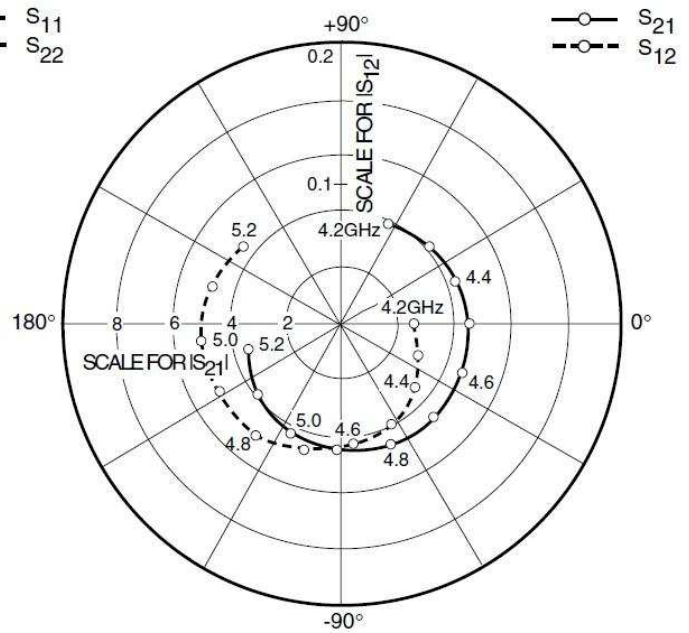
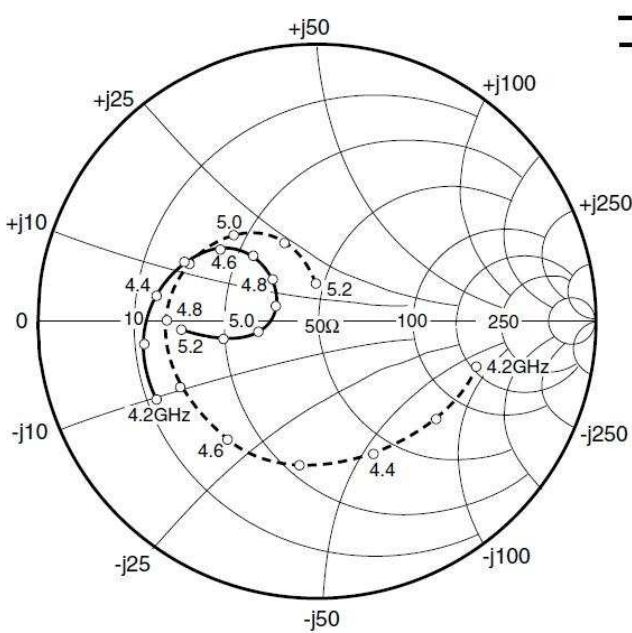

### S-PARAMETERS

$V_{DS} = 10V, I_{DS} = 2200mA$

FREQUENCY (MHz)	S11		S21		S12		S22	
	MAG	ANG	MAG	ANG	MAG	ANG	MAG	ANG
4200	0.645	-153.3	3.953	61.9	0.051	-0.3	0.592	-16.8
4300	0.627	-171.7	4.154	41.9	0.060	-22.2	0.554	-40.3
4400	0.578	171.7	4.326	21.1	0.069	-40.4	0.521	-67.5
4500	0.520	156.4	4.501	-0.1	0.079	-62.9	0.521	-97.4
4600	0.428	143.8	4.589	-22.2	0.087	-84.8	0.540	-127.0
4700	0.325	134.2	4.642	-45.1	0.095	-106.3	0.550	-153.9
4800	0.216	135.2	4.578	-68.2	0.100	-127.1	0.540	-179.7
4900	0.158	160.9	4.434	-92.0	0.100	-150.4	0.504	156.1
5000	0.214	-168.1	4.217	-116.1	0.101	-172.5	0.430	134.0
5100	0.346	-167.2	3.892	-140.6	0.096	164.6	0.306	113.7
5200	0.482	-175.7	3.469	-165.3	0.089	141.9	0.136	95.9

**Case Style "IB"**  
**Metal-Ceramic Hermetic Package**

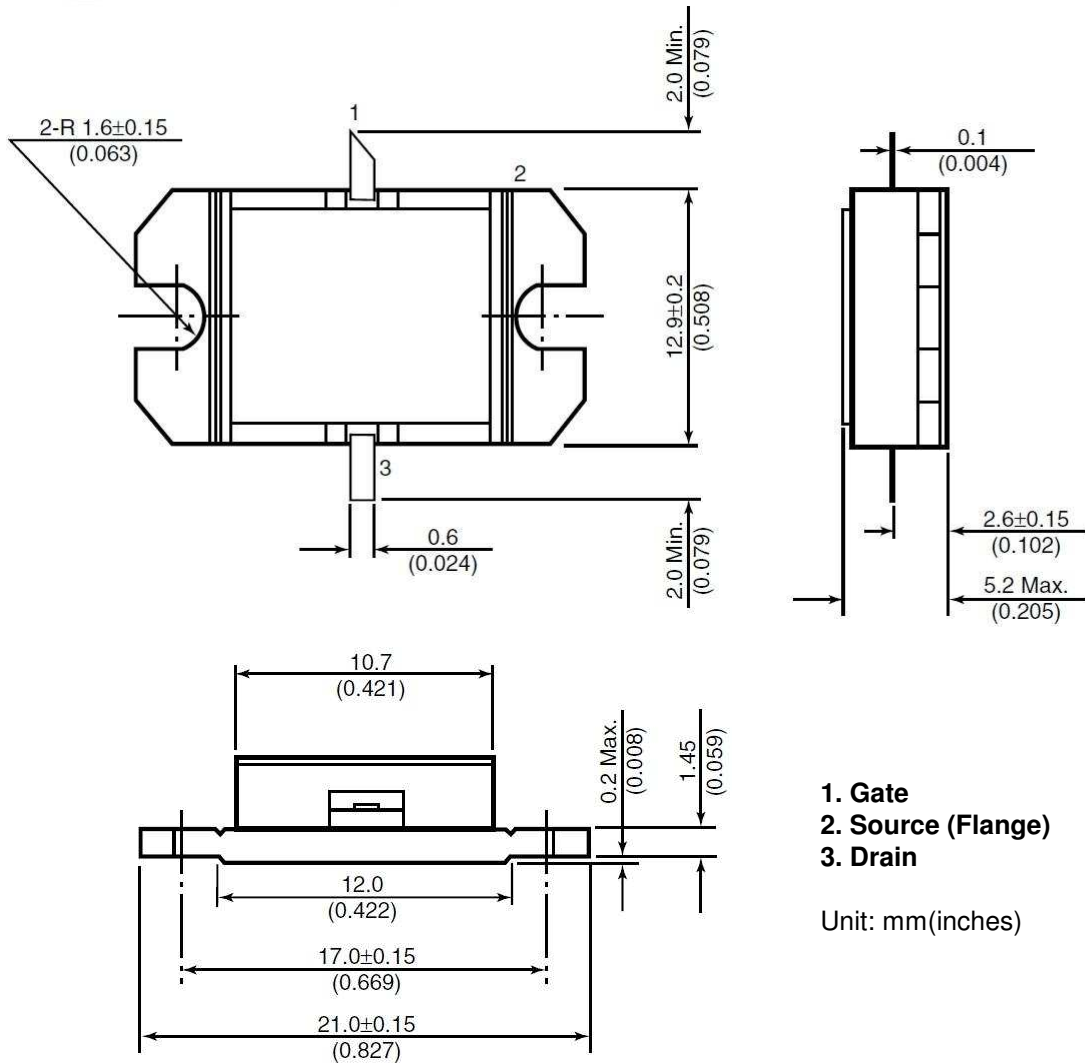



# **FLM4450-8F**

***C-Band Internally Matched FET***

**For further information please contact:**

**<http://global-sei.com/Electro-optic/about/office.html>**

### **CAUTION**

This product contains **gallium arsenide (GaAs)** which can be hazardous to the human body and the environment. For safety, observe the following procedures:

- Do not put these products into the mouth.
- Do not alter the form of this product into a gas, powder, or liquid through burning, crushing, or chemical processing as these by-products are dangerous to the human body if inhaled, ingested, or swallowed.
- Observe government laws and company regulations when discarding this product. This product must be discarded in accordance with methods specified by applicable hazardous waste procedures.