

FEATURES

- High Output Power: Pout=33.0dBm (typ.)
- High Linear Gain: GL=26.0dB (typ.)
- Broad Band: 9.5 to 13.3GHz
- Impedance Matched Zin/Zout=50ohm
- Small Hermetic Metal-Ceramic SMT Package(VU)

DESCRIPTION

The EMM5068VU is a MMIC amplifier that contains a three-stages amplifier, internally matched, for standard communications band in the 9.5 to 13.3GHz frequency range.

SEDI's stringent Quality Assurance Program assures the highest reliability and consistent performance.

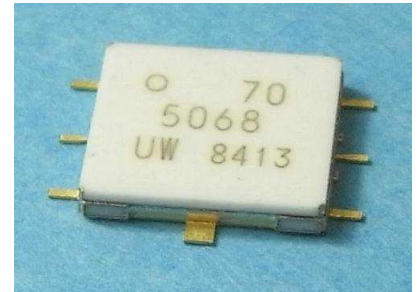

ABSOLUTE MAXIMUM RATING

Item	Symbol	Rating	Unit
Drain-Source Voltage	V _{DD}	10	V
Gate-Source Voltage	V _{GG}	-3	V
Input Power	P _{in}	26	dBm
Storage Temperature	T _{stg}	-55 to +125	deg.C

RECOMMENDED OPERATING CONDITIONS

Item	Symbol	Conditions	Unit
Drain-Source Voltage	V _{DD}	<=6	V
Input Power	P _{in}	<=12	dBm
Operating Case Temperature	Top	-40 to +85	deg.C

ELECTRICAL CHARACTERISTICS (Case Temperature Tc=25deg.C)

Item	Symbol	Test Conditions	Limits			Unit
			Min.	Typ.	Max.	
Frequency Range	f	VDD=6V	9.5	-	13.3	GHz
Output Power at 1dB G.C.P.	P _{1dB}	IDD=1300mA Zs=Zl=50ohm	31 ^{*1} 28 ^{*2}	33 ^{*1} 31 ^{*2}	-	dBm
Power Gain at 1dB G.C.P.	G _{1dB}	*1:f=9.5 to 11.7GHz *2:f=11.7 to 13.3GHz	22 ^{*1} 20 ^{*2}	25 ^{*1} 23 ^{*2}	-	dB
Power-added Efficiency at 1dB G.C.P.	η _{add}		-	22 ^{*1} 15 ^{*2}	-	%
Third Order Intermodulation*	IM ₃	*: Δf=10MHz ,	-37	-40	-	dBc
Drain Current at 1dB G.C.P.	I _{DD}	2-Tone Test, Pout=20dBm S.C.L.	-	1500 ^{*1} 1400 ^{*2}	2400 ^{*1} 2400 ^{*2}	mA
Input Return Loss (at Pin=-20dBm)	RL _{in}		-	-8	-	dB
Output Return Loss (at Pin=-20dBm)	RL _{out}		-	-8	-	dB

G.C.P.:Gain Compression Point, S.C.L.:Single Carrier Level

ESD	Class 0	<=250V
------------	----------------	------------------

Note : Based on JEDEC JESD22-A114C (C=100pF, R=1.5kohm)

CASE STYLE	VU
RoHs Compliance	Yes

ORDERING INFORMATION

Part Number	Minimum Order Quantity	Packing
EMM5068VU	No Limitation	48 pcs./Tray × 4 Tray = 192 pcs./Packing
EMM5068VUT	500pcs.	500 pcs./Reel × 1 Reel = 500 pcs./Packing

OUTPUT POWER vs. FREQUENCY

VDD=6V, IDD(DC)=1300mA

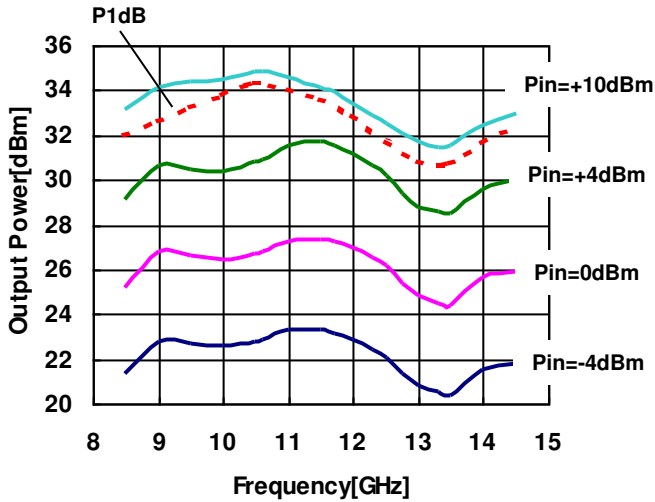

OUTPUT POWER, DRAIN CURRENT vs. INPUT POWER

VDD=6V, IDD(DC)=1300mA

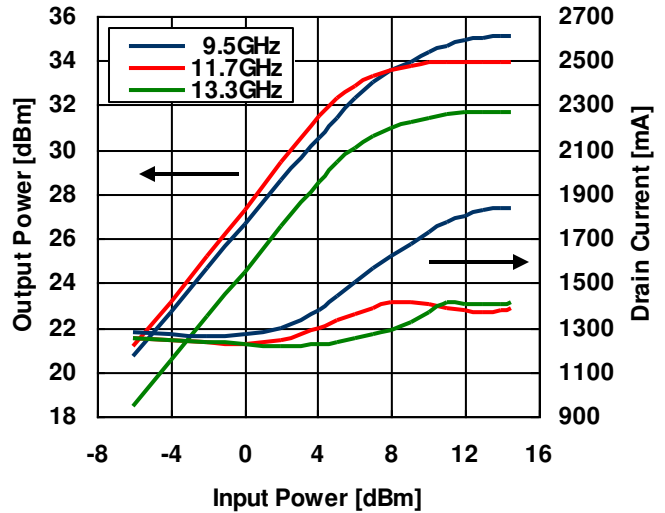

POWER ADDED EFFICIENCY vs. FREQUENCY

VDD=6V, IDD(DC)=1300mA

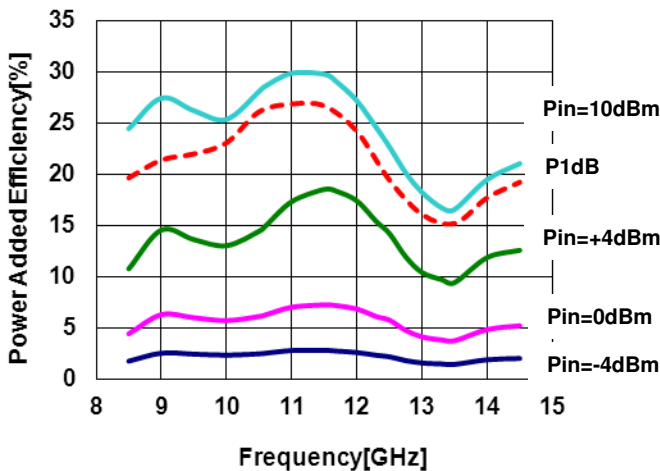

IMD vs. FREQUENCY

VDD=6V, IDD(DC)=1300mA, Pout=20dBm S.C.L.

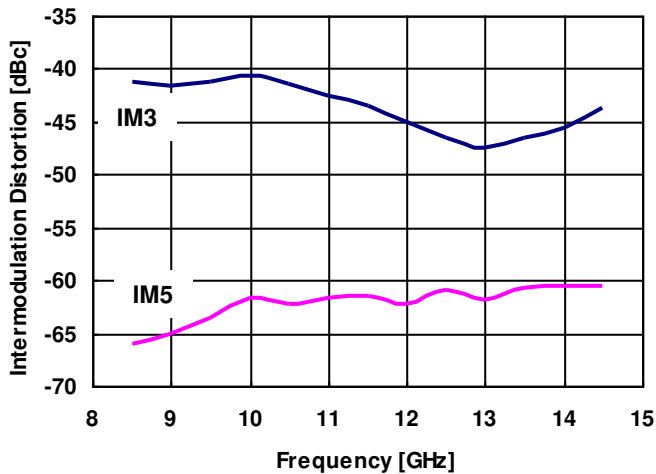

IMD vs. OUTPUT POWER

VDD=6V, IDD(DC)=1300mA

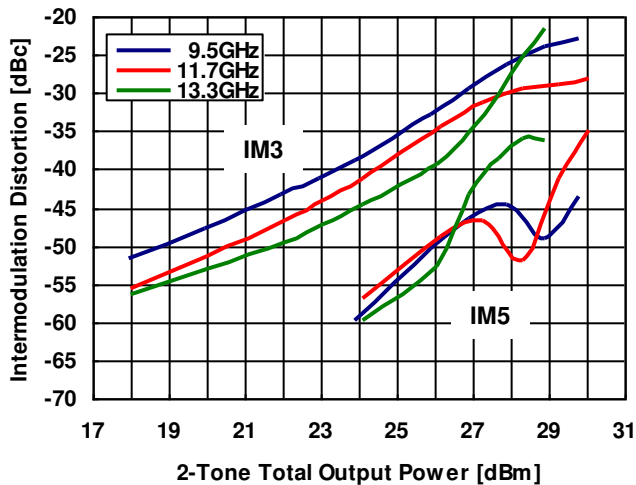

OUTPUT POWER, DRAIN CURRENT vs. INPUT POWER by Drain Voltage

IDD(DC)=1300mA @9.5GHz

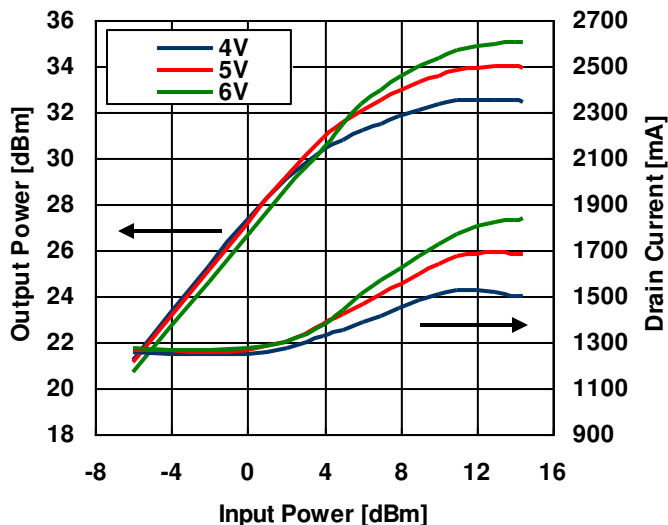

OUTPUT POWER, DRAIN CURRENT vs. INPUT POWER by Drain Voltage

IDD(DC)=1300mA @11.7GHz

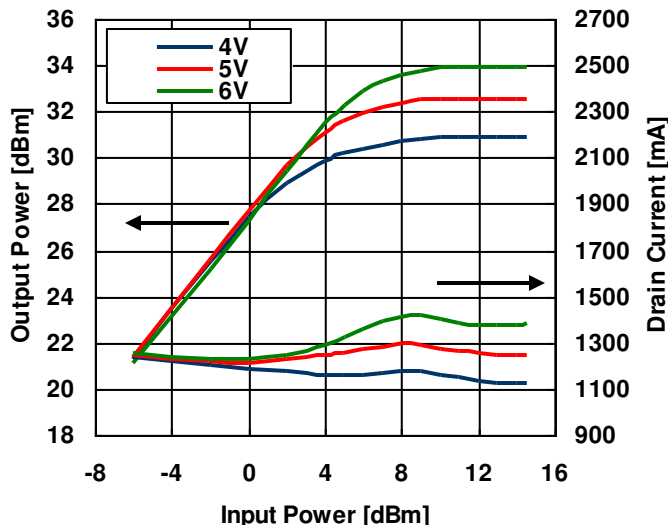

OUTPUT POWER, DRAIN CURRENT vs. INPUT POWER by Drain Voltage

IDD(DC)=1300mA @13.3GHz

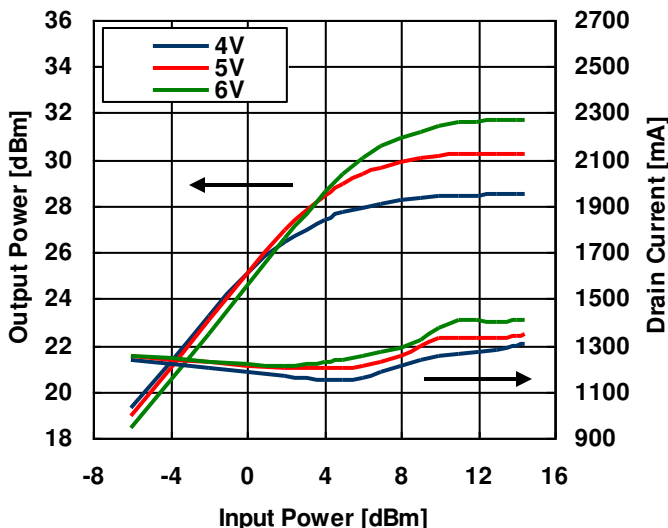

OUTPUT POWER, GAIN vs. DRAIN VOLTAGE

IDD(DC)=1300mA

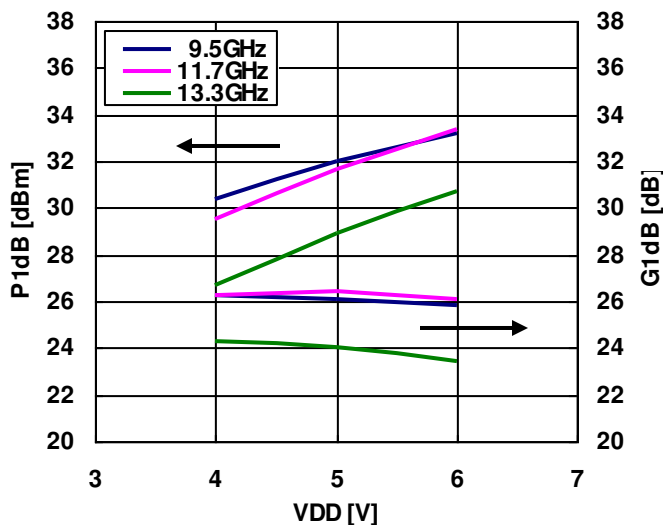

OUTPUT POWER, DRAIN CURRENT vs. INPUT POWER by Drain Current

VDD=6V @9.5GHz

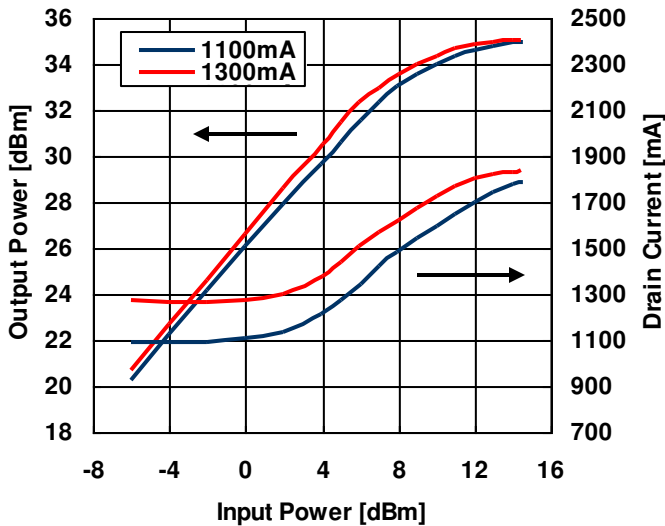

OUTPUT POWER, DRAIN CURRENT vs. INPUT POWER by Drain Current

VDD=6V @11.7GHz

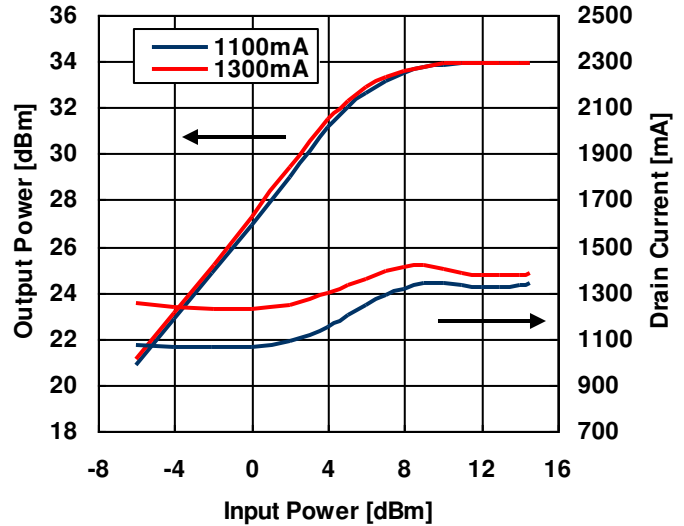

OUTPUT POWER, DRAIN CURRENT vs. INPUT POWER by Drain Current

VDD=6V @13.3GHz

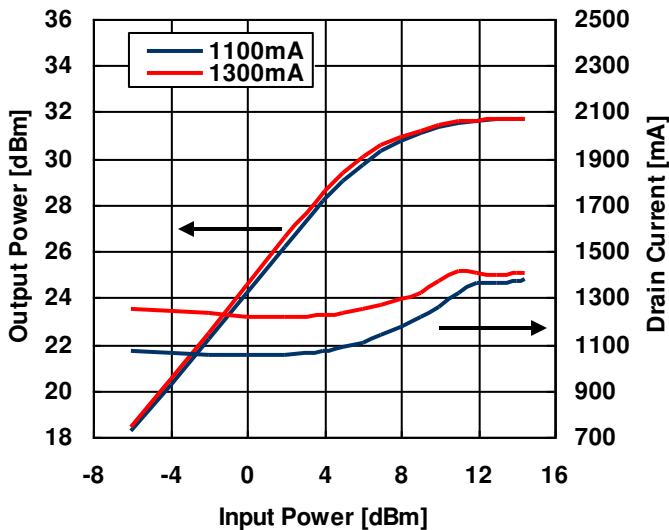

OUTPUT POWER, GAIN vs. Drain Current

VDD=6V

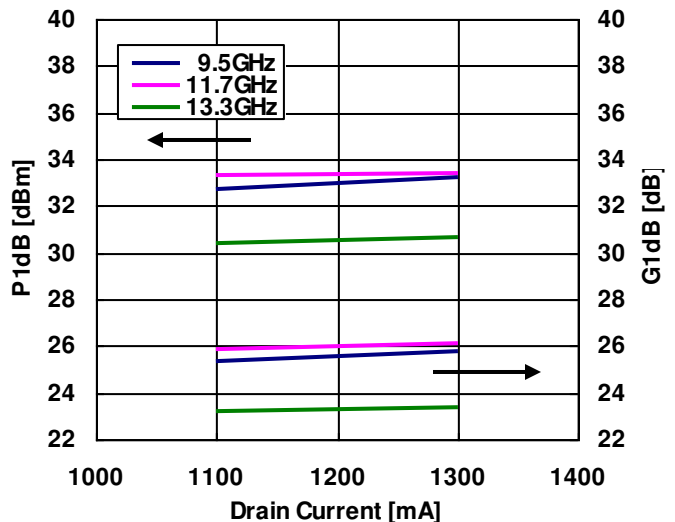

**IMD PERFORMANCE vs. OUTPUT POWER
by Drain Voltage**

IDD(DC)=1300mA @9.5GHz

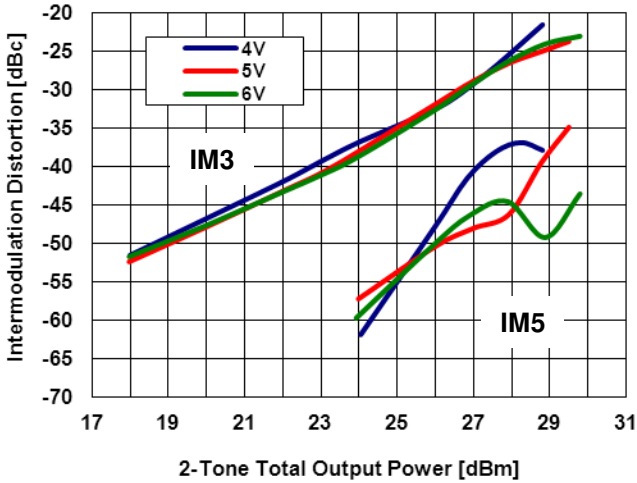

**IMD PERFORMANCE vs. OUTPUT POWER
by Drain Voltage**

IDD(DC)=1300mA @11.7GHz

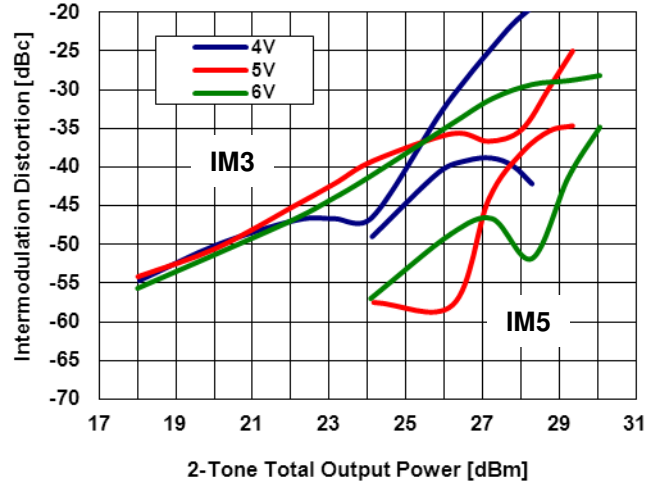

**IMD PERFORMANCE vs. OUTPUT POWER
by Drain Voltage**

IDD(DC)=1300mA @13.3GHz

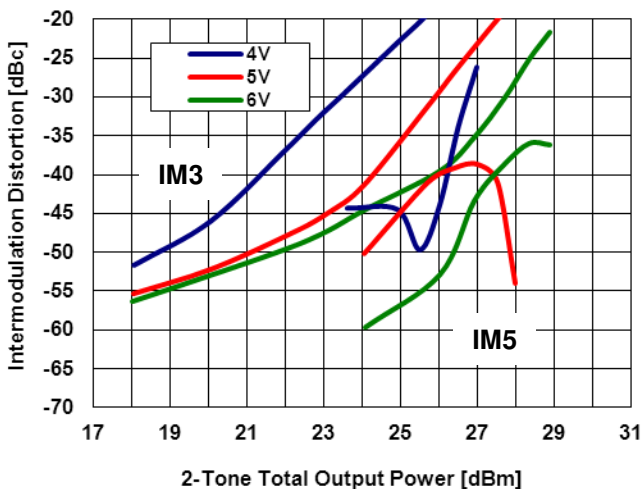

IMD PERFORMANCE vs. OUTPUT POWER
by Drain Current

VDD=6V @9.5GHz

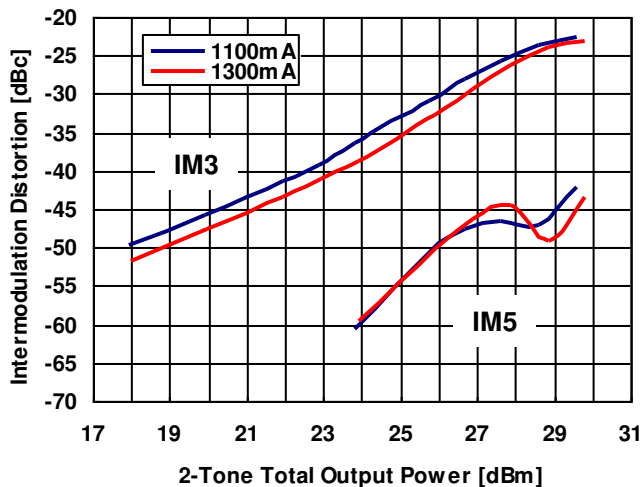

IMD PERFORMANCE vs. OUTPUT POWER
by Drain Current

VDD=6V @11.7GHz

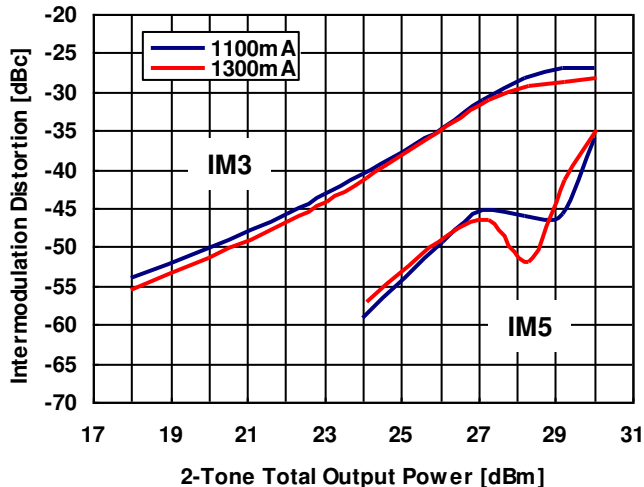

IMD PERFORMANCE vs. OUTPUT POWER
by Drain Current

VDD=6V @13.3GHz

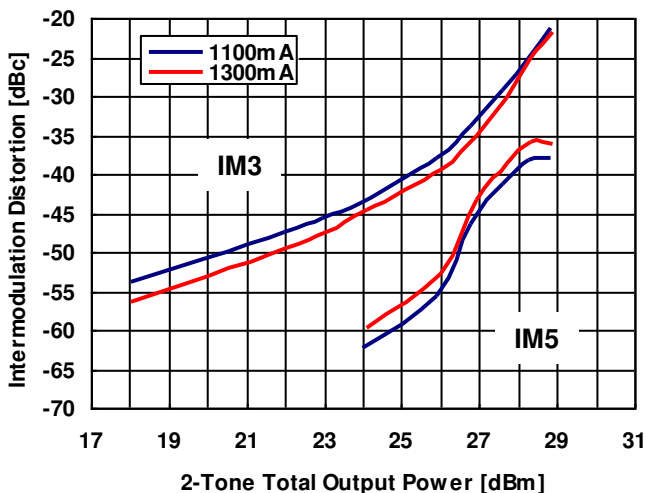

OUTPUT POWER, GAIN vs. TEMPERATURE

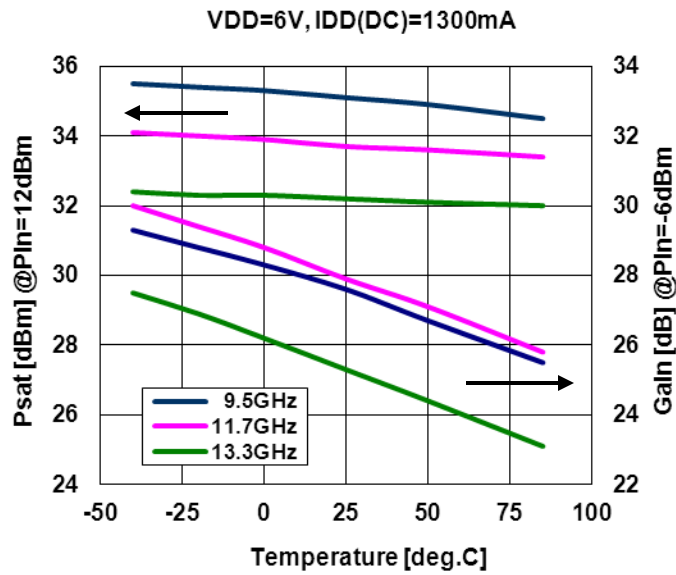

■ S-PARAMETER

VDD=6V, IDD(DC)=1300mA

Input/Output Return Loss vs. Frequency

VDD=6V, IDD=1300mA

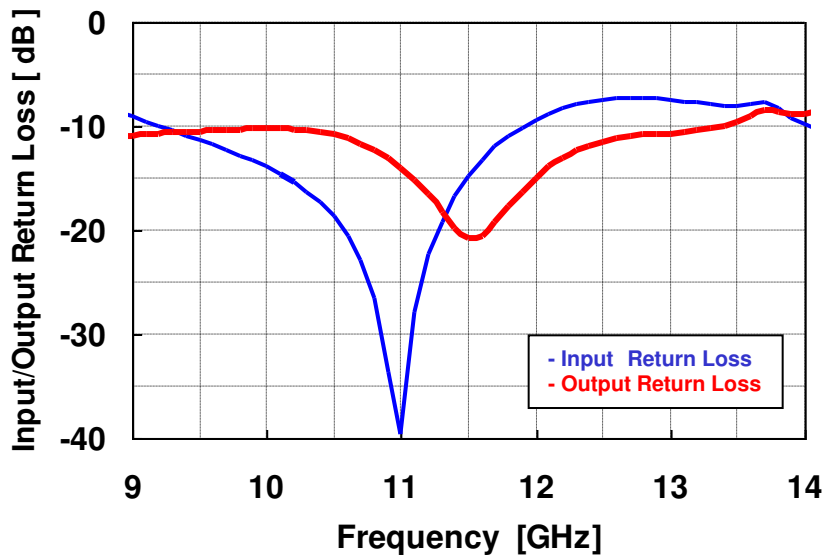

Small Signal Gain vs. Frequency

VDD=6V, IDD=1300mA

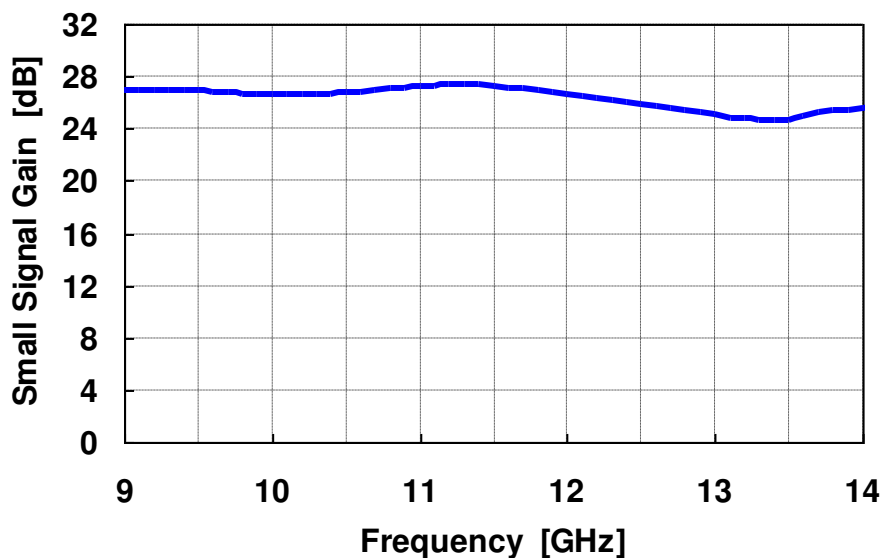

■S-PARAMETER

VDD=6V, IDD(DC)=1300mA

Frequency [GHz]	S11		S21		S12		S22	
	MAG	ANG	MAG	ANG	MAG	ANG	MAG	ANG
9.3	0.299	-75.9	22.375	-37.1	0.001	-159.0	0.293	-24.1
9.4	0.286	-79.8	22.230	-51.7	0.001	-171.2	0.296	-29.0
9.5	0.272	-83.1	22.101	-66.1	0.001	-166.0	0.297	-33.3
9.6	0.258	-86.8	21.906	-80.0	0.001	-174.2	0.300	-37.5
9.7	0.243	-90.2	21.784	-93.7	0.000	-174.7	0.304	-40.9
9.8	0.229	-93.7	21.610	-107.1	0.001	-162.9	0.305	-44.2
9.9	0.217	-97.2	21.473	-120.1	0.001	-166.4	0.307	-47.4
10.0	0.203	-99.4	21.385	-133.1	0.001	-170.5	0.308	-50.2
10.1	0.186	-102.3	21.328	-145.8	0.000	179.6	0.307	-52.9
10.2	0.171	-105.8	21.373	-158.5	0.000	-177.1	0.305	-55.8
10.3	0.153	-108.6	21.461	-171.0	0.001	-154.3	0.301	-58.2
10.4	0.136	-111.9	21.575	176.5	0.001	-145.5	0.294	-61.0
10.5	0.117	-113.8	21.702	163.9	0.001	-153.6	0.287	-63.4
10.6	0.094	-115.0	21.904	151.3	0.001	-152.2	0.276	-65.7
10.7	0.071	-118.0	22.113	138.4	0.001	-143.1	0.261	-67.9
10.8	0.047	-119.8	22.540	125.6	0.001	-144.8	0.243	-70.1
10.9	0.021	-112.0	22.708	112.4	0.001	-139.4	0.224	-71.4
11.0	0.010	6.6	22.883	99.4	0.001	-142.2	0.200	-72.3
11.1	0.040	30.3	23.161	85.7	0.001	-143.1	0.174	-72.2
11.2	0.076	31.8	23.333	72.0	0.001	-131.6	0.148	-69.8
11.3	0.110	30.0	23.299	58.4	0.001	-134.6	0.123	-63.9
11.4	0.146	26.0	23.283	44.8	0.001	-136.1	0.102	-53.2
11.5	0.181	21.2	23.129	30.9	0.001	-143.5	0.092	-36.7
11.6	0.216	16.4	22.757	17.3	0.001	-147.5	0.093	-18.2
11.7	0.251	12.0	22.587	3.7	0.001	-143.9	0.109	-4.8
11.8	0.282	8.4	22.307	-9.8	0.001	-136.8	0.131	4.1
11.9	0.307	4.0	21.801	-23.0	0.001	-144.0	0.154	8.5
12.0	0.337	-0.2	21.387	-36.2	0.001	-130.5	0.179	10.1
12.1	0.359	-4.4	21.113	-49.4	0.001	-141.1	0.202	10.5
12.2	0.385	-8.6	20.670	-62.4	0.001	-131.9	0.223	9.5
12.3	0.403	-12.0	20.338	-75.0	0.001	-133.6	0.240	8.5
12.4	0.414	-16.4	20.065	-88.1	0.001	-120.0	0.255	6.8
12.5	0.426	-20.5	19.624	-101.1	0.001	-121.0	0.267	4.9
12.6	0.433	-24.3	19.288	-114.4	0.001	-117.6	0.276	3.2
12.7	0.436	-28.3	19.027	-127.2	0.001	-119.3	0.282	1.4
12.8	0.436	-31.4	18.654	-140.1	0.002	-111.7	0.287	0.1
12.9	0.429	-34.4	18.195	-152.8	0.002	-112.5	0.290	-1.2
13.0	0.421	-37.5	17.858	-165.5	0.002	-113.4	0.292	-2.3
13.1	0.415	-39.8	17.512	-178.2	0.002	-117.5	0.297	-2.8
13.2	0.408	-41.9	17.274	169.3	0.002	-123.3	0.300	-3.6
13.3	0.402	-43.8	17.111	157.4	0.003	-126.9	0.309	-4.3
13.4	0.398	-45.3	17.108	144.9	0.003	-131.6	0.319	-5.4
13.5	0.394	-47.3	17.181	132.6	0.004	-132.3	0.334	-6.8

ΔTch vs. DRAIN VOLTAGE
 (Reference Data)
 IDD(DC)=1300mA

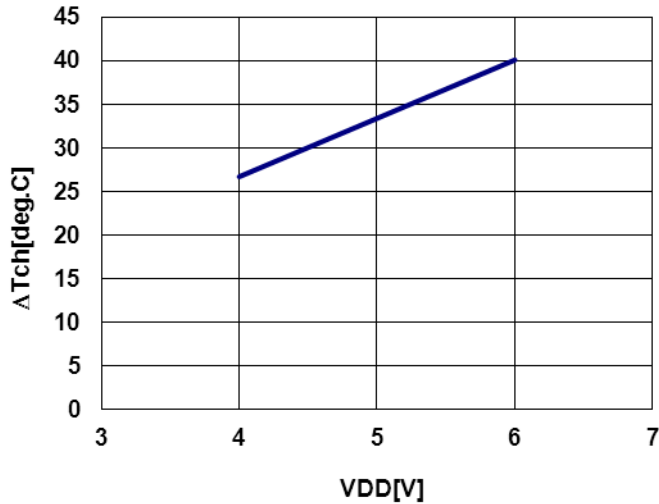

Note : ΔTch : Temperature Rise from Backside of Package to Channel

MTTF vs. Tch

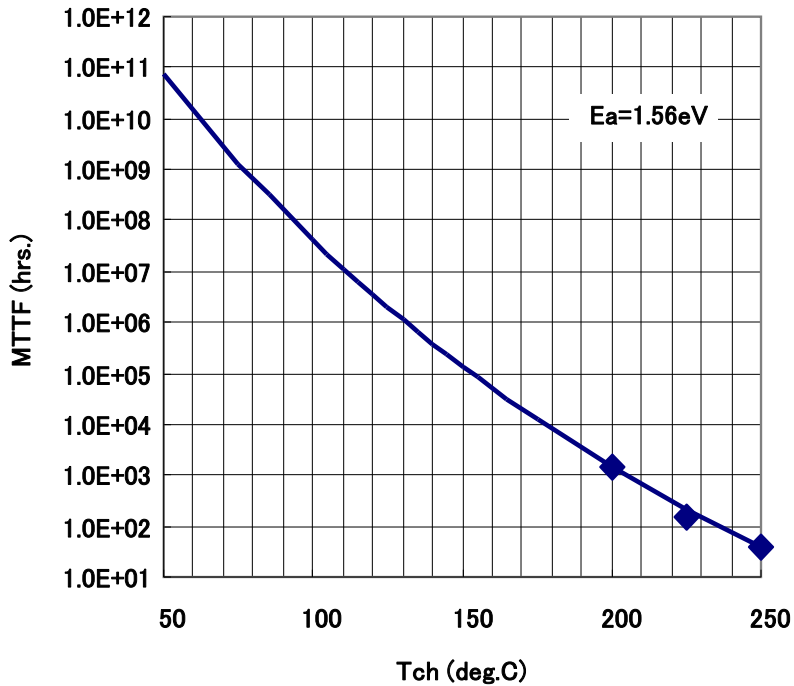

■ Block diagram

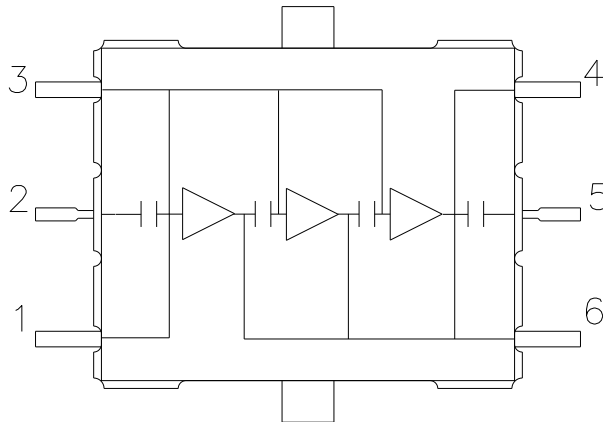

PIN ASSIGNMENT

- 1 : VGG
- 2 : RF in
- 3 : VGG
- 4 : VDD
- 5 : RF out
- 6 : VDD

■ Recommended Bias Circuit

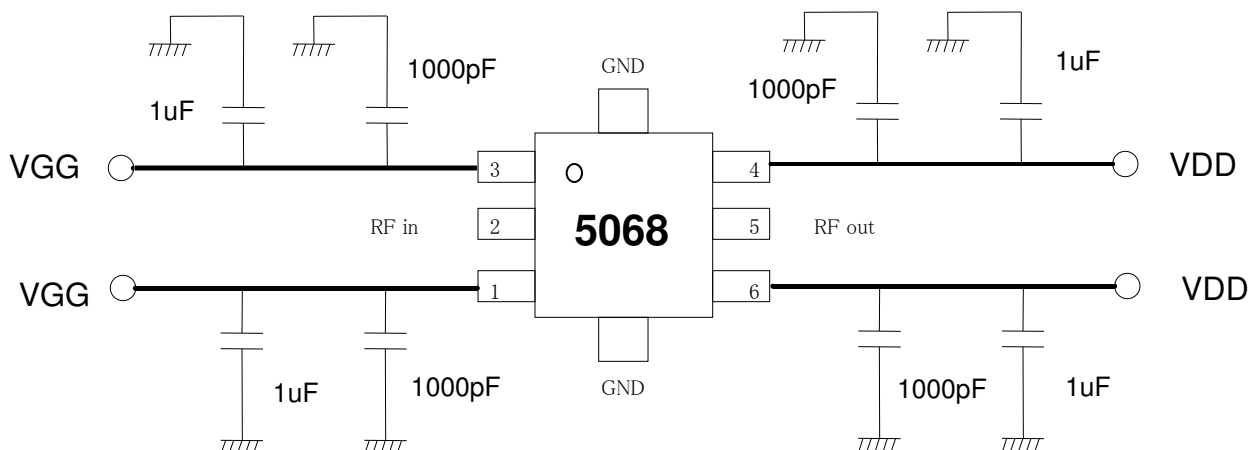

Note 1: The capacitors are recommended on the bias supply line, close to the package, in order to prevent video oscillations which could damage the module.

Note 2: Two pins named VGG are internally connected.

Note 3: Two pins named VDD are internally connected.

Package Outline

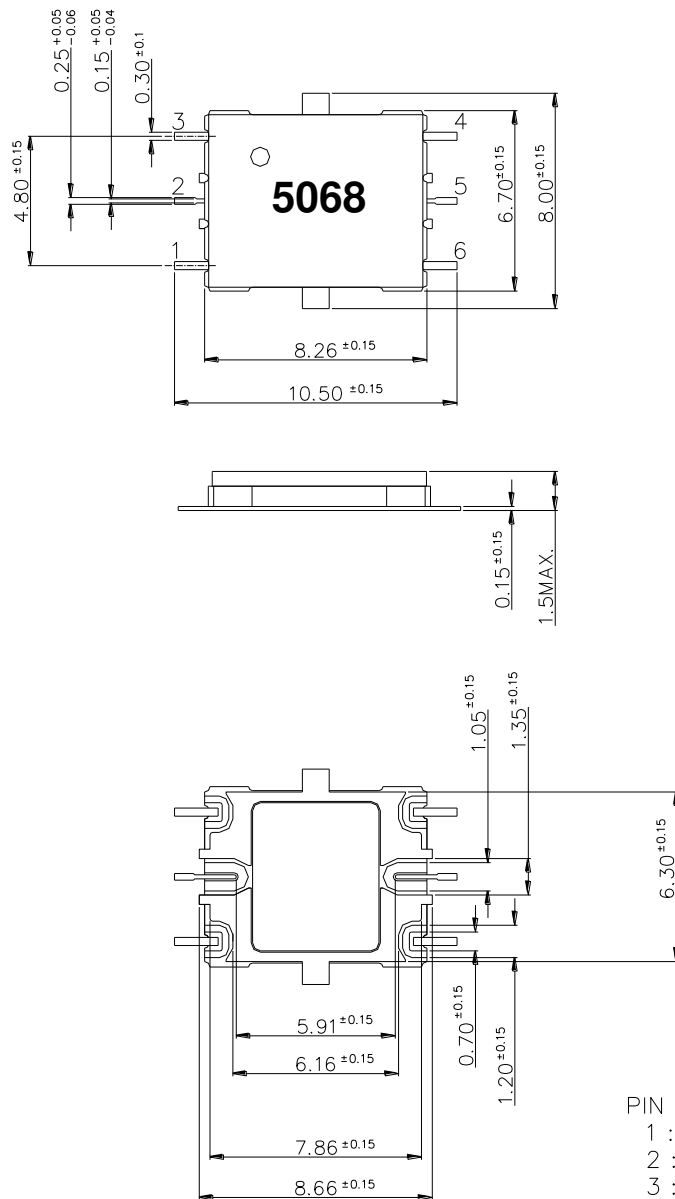

PIN Assignments

- 1 : VGG
- 2 : RF in
- 3 : VGG
- 4 : VDD
- 5 : RF out
- 6 : VDD

Unit : mm

■ **Marking Information**

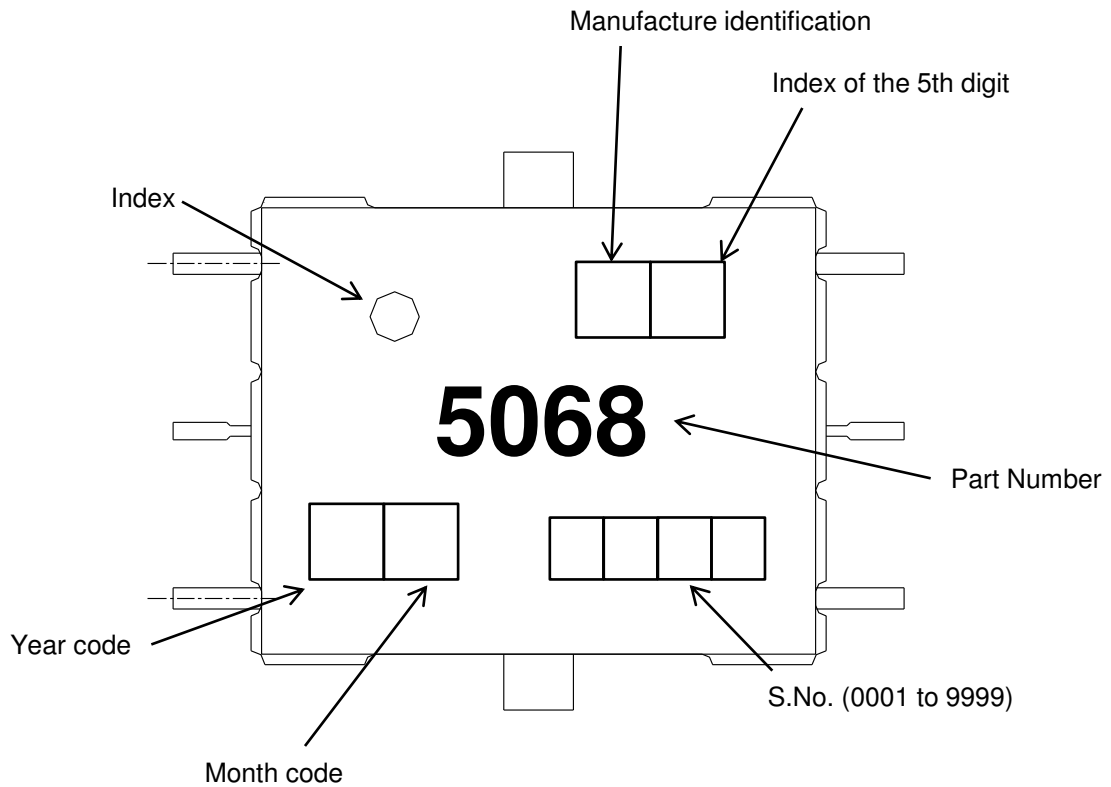

<Year code>

Code	T	U	V	W	X	Y	Z	A	B
Year	2011	2012	2013	2014	2015	2016	2017	2018	2019

<Month code>

Code	H	M	N	P	R	S	T	U	W	X	Y	Z
Month	1	2	3	4	5	6	7	8	9	10	11	12

■ 4-inch Tray Packing (Part No. : EMM5068VU)

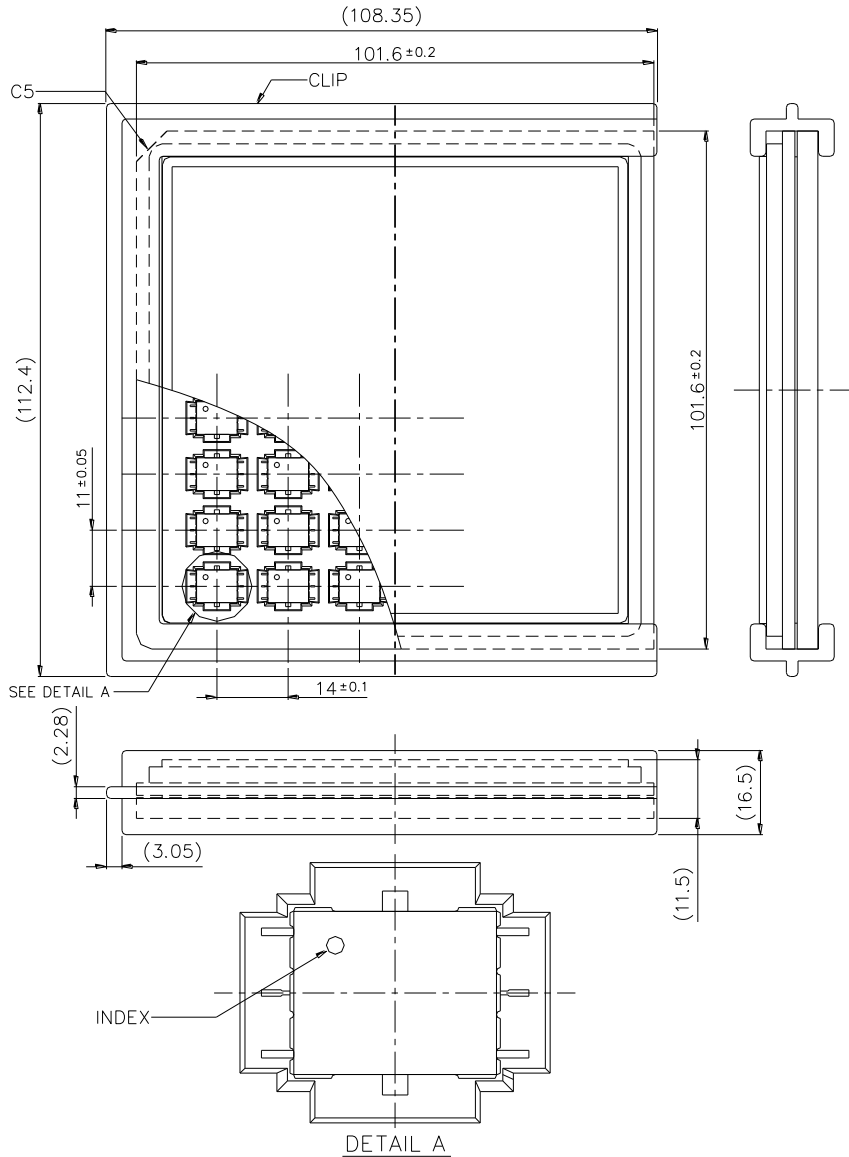

- (1) Maximum Quantity : 48 pcs./Tray
- (2) Tray Material : Conductive PS

■ Tape and Reel Packing (Part No. : EMM5068VUT)

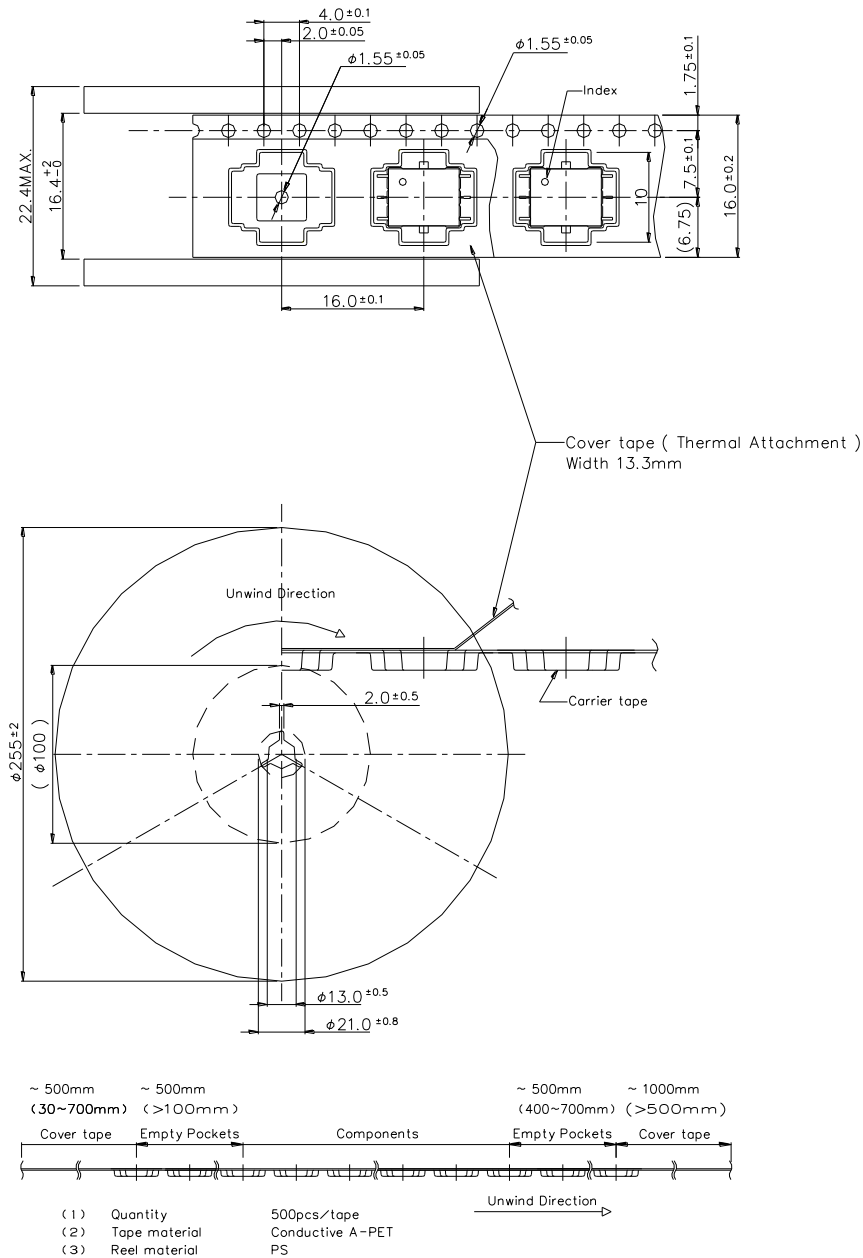

■ Mounting Method of SMD(Surface Mount Devices) for Lead-free solder

Mounting Condition

- (1) For soldering, Lead-free solder (Sn-3.0Ag-0.5Cu)*1 or equivalent shall be used.
(*1: The figure displays with weight %. A predominantly tin-rich alloy with 3.0% silver and 0.5% copper.)
- (2) A rosin type flux with a chlorine content of 0.2% or less shall be used. The rosin flux with low halogen content is recommended.
- (3) When soldering, use one of the following time / temperature methods for acceptable solder joints. Make sure the devices have been properly prepared with flux prior soldering.

* Reflow soldering method (Infrared reflow / Heat circulation reflow / Hot plate reflow):

Limit solder to 3 reflow cycles because resin is used in the modules manufacturing process. Excessive reflow cycles will effect the resin resulting in a potential failure or latent defect. The recommended reflow temperature profile is shown below. The temperature of the reflow profile must be measured at the device body surface.

Reflow temperature profile and condition:

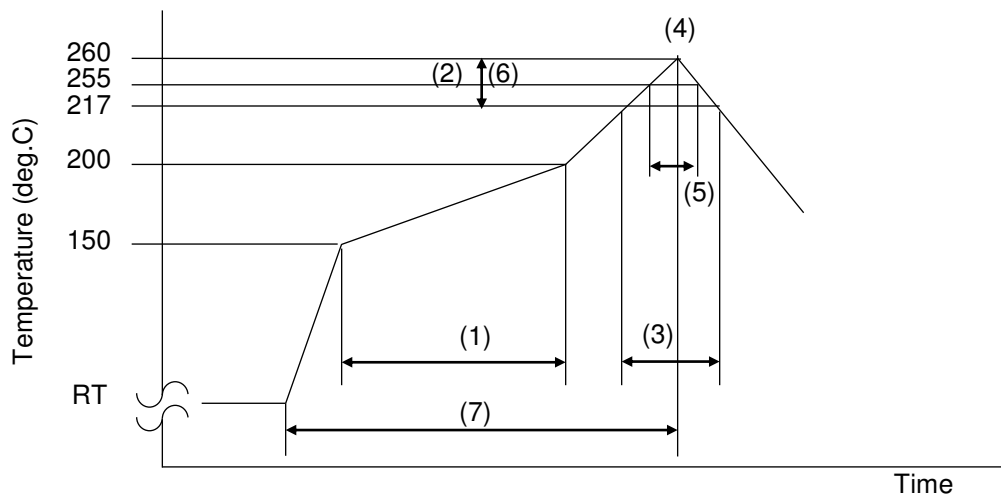

- | | |
|-------------------------------------|-------------------------------------|
| (1) Preheating: | 150 to 200 deg.C, 60 to 120 seconds |
| (2) Ramp-up Rate: | 3 deg.C /seconds max |
| (3) Liquidous temperature and time: | 217 deg.C, 60 to 150 seconds |
| (4) Peak Temperature: | 260 deg.C |
| (5) Time Peak Temperature: | 255deg.C, 30seconds max |
| (6) Ramp-down Rate: | 6 deg.C /seconds max |
| (7) Time RT to peak temperature: | 8 minutes max |

* Measurement point: Center of the package body surface

- (4) The above-recommended conditions were confirmed using the manufacture's equipment and materials. However, when soldering these products, the soldering condition should be verified by customer using their equipment and materials.

■ TUNING PERFORMANCE

Device performance at higher band (11.7 to 13.3GHz) can be improved by changing PCB line pattern.

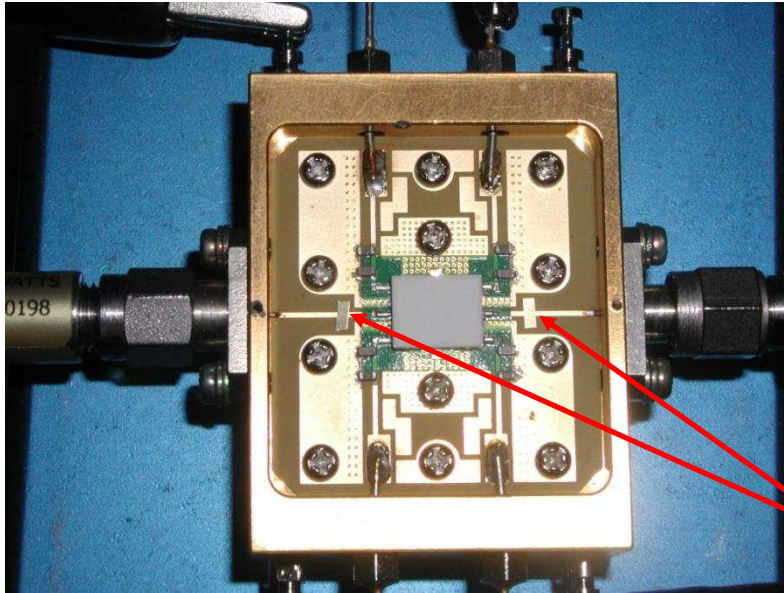

PCB: RO4003
Er : 3.38
Thickness : 0.2mm

Tuning Stub

Output Power vs. Frequency

IMD vs. Output Power

VDD=6V, IDD(DC)=1300mA, with-Tuning

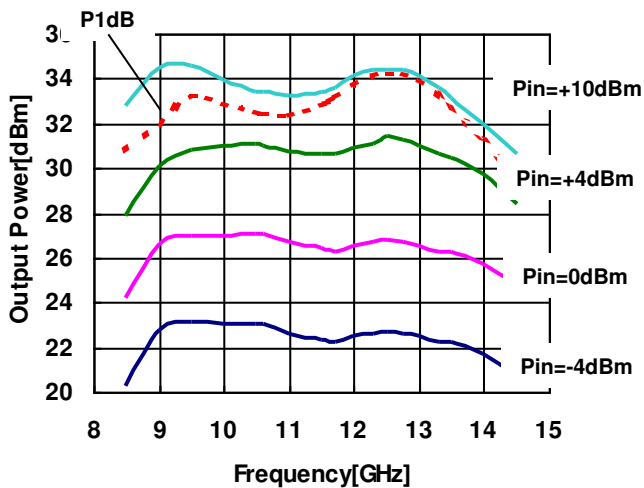

VDD=6V, IDD(DC)=1300mA, with-Tuning

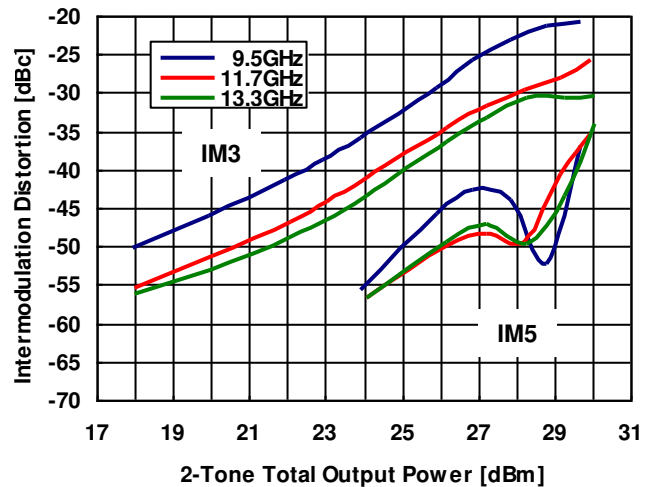

For further information please contact:

<http://global-sei.com/Electro-optic/about/office.html>

CAUTION

This product contains **gallium arsenide (GaAs)** which can be hazardous to the human body and the environment. For safety, observe the following procedures:

- Do not put these products into the mouth.
- Do not alter the form of this product into a gas, powder, or liquid through burning, crushing, or chemical processing as these by-products are dangerous to the human body if inhaled, ingested, or swallowed.
- Observe government laws and company regulations when discarding this product. This product must be discarded in accordance with methods specified by applicable hazardous waste procedures.