

FEATURES

- High Output Power: Pout=33dBm (typ.)
- High Linear Gain: GL=27dB (typ.)
- Broad Band: 5.8 to 8.5GHz
- Impedance Matched Zin/Zout=50ohm
- Small Hermetic Metal-Ceramic SMT Package(VU)

DESCRIPTION

The EMM5074VU is a wide band power amplifier MMIC that contains a three stage amplifier, internally matched, for standard communications band in 5.8 to 8.5GHz frequency range. SEDI's stringent Quality Assurance Program assures the highest reliability and consistent performance.



ABSOLUTE MAXIMUM RATING

Item	Symbol	Rating	Unit
Drain-Source Voltage	V _{DD}	10	V
Gate-Source Voltage	V _{GG}	-3	V
Input Power	P _{in}	+26	dBm
Storage Temperature	T _{stg}	-55 to +125	deg.C

RECOMMENDED OPERATING CONDITIONS

Item	Symbol	Condition	Unit
Drain-Source Voltage	V _{DD}	<=6	V
Input Power	P _{in}	<=10	dBm
Operating Case Temperature	T _C	-40 to +85	deg.C

ELECTRICAL CHARACTERISTICS (Case Temperature Tc=25deg.C)

Item	Symbol	Test Conditions	Limits			Unit
			Min.	Typ.	Max.	
Frequency Range	f	V _{DD} =+6V	5.8	-	8.5	GHz
Output Power at 1dB G.C.P.	P _{1dB}	I _{DD} (DC)=1200mA typ. Z _s =Z _l =50ohm	30 ^{*1} 31 ^{*2}	32 ^{*1} 33 ^{*2}	-	dBm
Power Gain at 1dB G.C.P.	G _{1dB}	*1:f=5.8 to 7.1GHz	23	26	-	dB
Power-added Efficiency at 1dB G.C.P.	η _{add}	*2:f=7.1 to 8.5GHz	-	18 ^{*1} 22 ^{*2}	-	%
Third Order Intermodulation*	IM ₃	*:Δf=10MHz ,	-37	-42	-	dBc
Drain Current at 1dB G.C.P.	I _{DD}	2-Tone Test , Pout=20dBm S.C.L.	-	1400 ^{*1} 1450 ^{*2}	1800 ^{*1} 1800 ^{*2}	mA
Input Return Loss (at Pin=-20dBm)	RL _{in}		-	15	-	dB
Output Return Loss (at Pin=-20dBm)	RL _{out}		-	15	-	dB

G.C.P.:Gain Compression Point, S.C.L.:Single Carrier Level

ESD	Class 0	<= 250V
------------	----------------	-------------------

Note : Based on JEDEC JESD22-A114 (C=100pF, R=1.5kohm)

CASE STYLE	VU
-------------------	-----------

RoHs Compliance	Yes
------------------------	------------

ORDERING INFORMATION

Part Number	Order Unit	Packing
EMM5074VU	No Limitation	48 pcs./Tray × 4 Tray = 192 pcs./Packing
EMM5074VUT	500pcs.	500 pcs./Reel × 1 Reel = 500 pcs./Packing

Output Power vs. Frequency

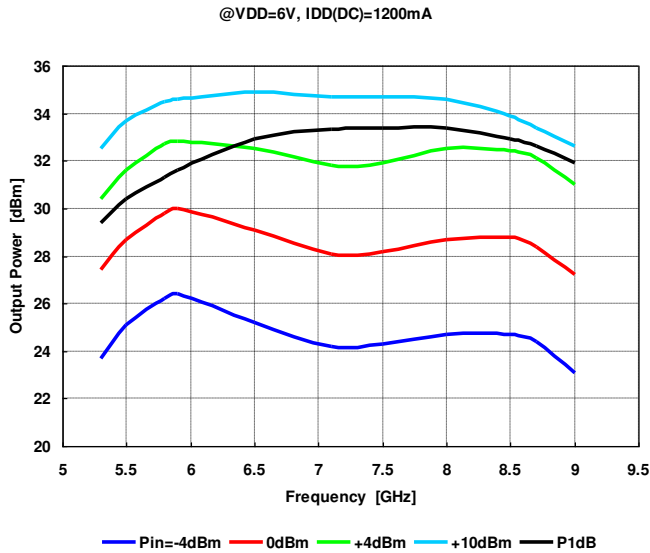

Output Power, Drain Current vs. Input Power

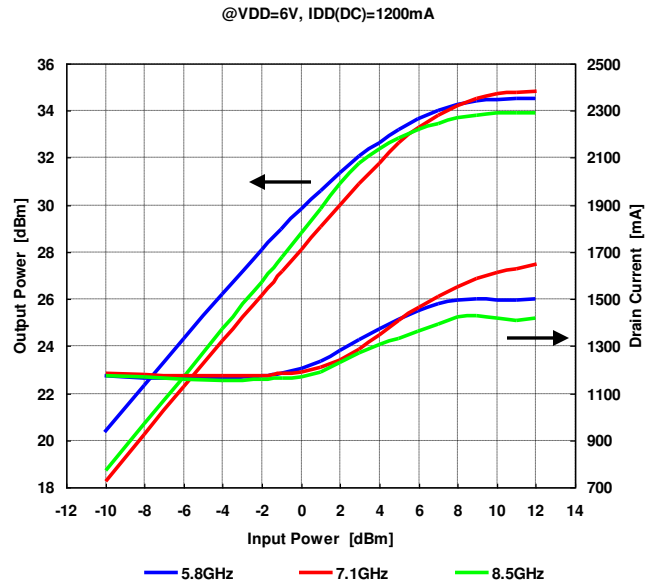

Power Added Efficiency vs. Frequency

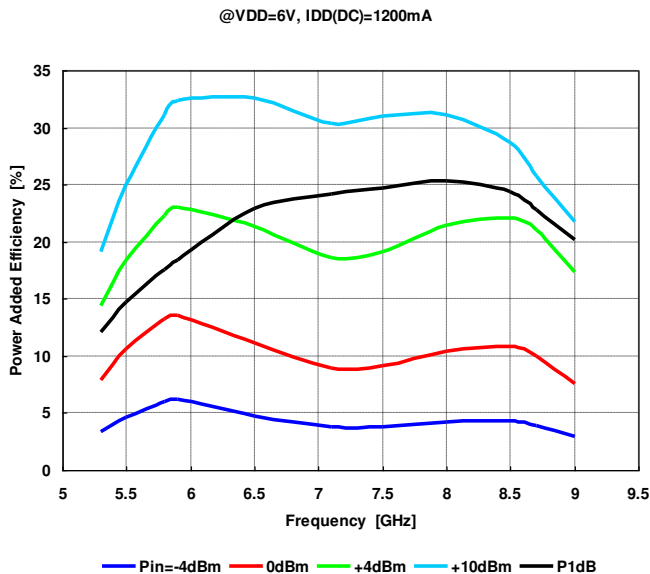

IM3 vs. Frequency

@VDD=6V, IDD(DC)=1200mA, @Po=20dBm S.C.L.

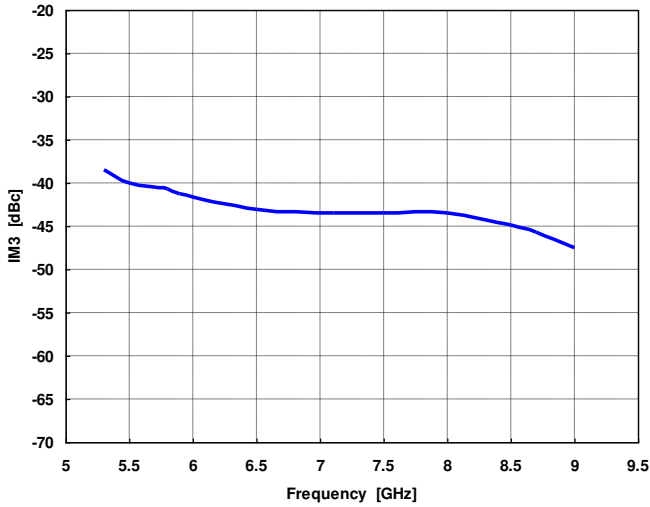

IMD vs. Output Power

@VDD=6V, IDD(DC)=1200mA

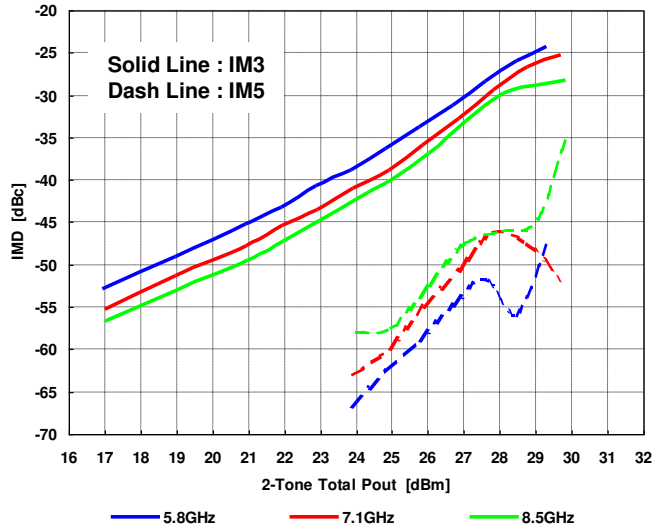

P1dB, G1dB vs. Frequency by Drain Voltage

@IDD(DC)=1200mA

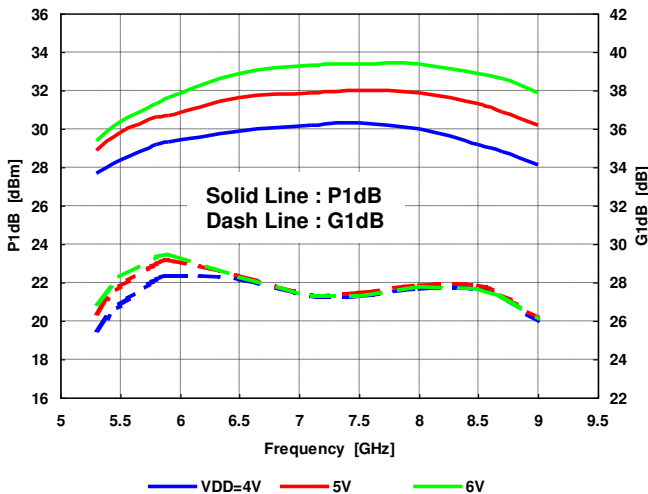

P1dB, G1dB vs. Frequency by Drain Current

@VDD=6V

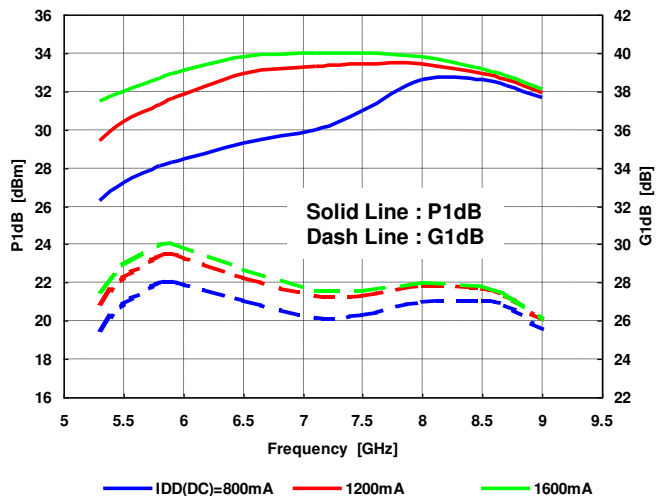

Output Power, Drain Current vs. Input Power by Drain Voltage

@f=5.8GHz, IDD(DC)=1200mA

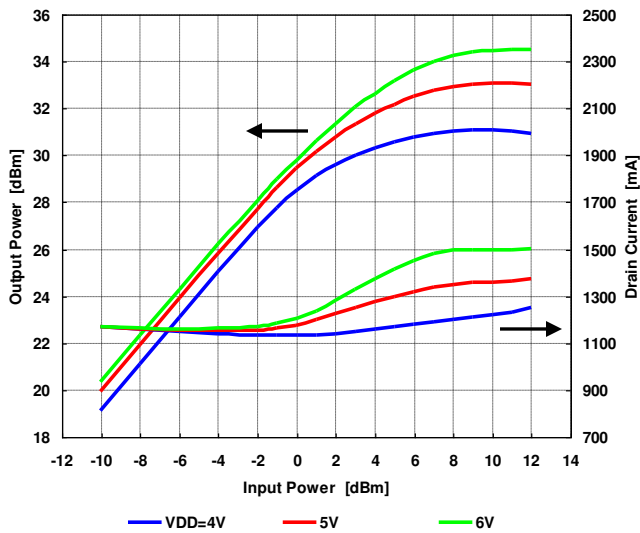

Output Power, Drain Current vs. Input Power by Drain Voltage

@f=7.1GHz, IDD(DC)=1200mA

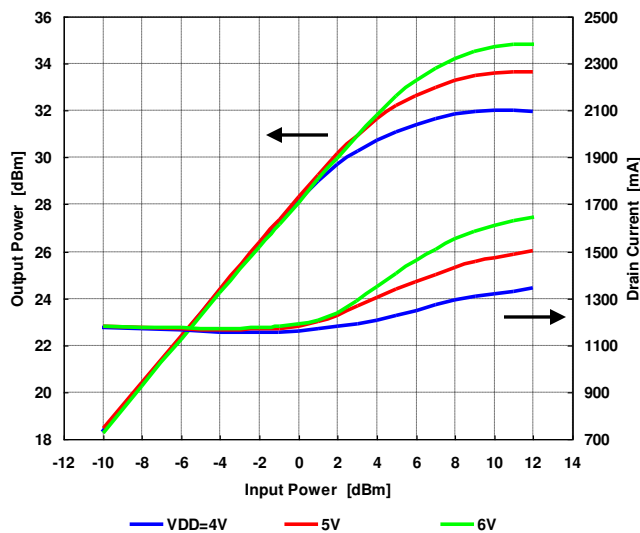

Output Power, Drain Current vs. Input Power by Drain Voltage

@f=8.5GHz, IDD(DC)=1200mA

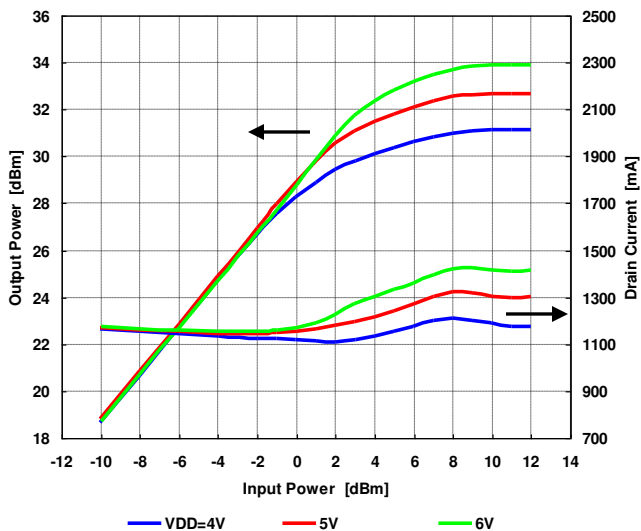

Output Power, Drain Current vs. Input Power by Drain Current

@f=5.8GHz, VDD=6V

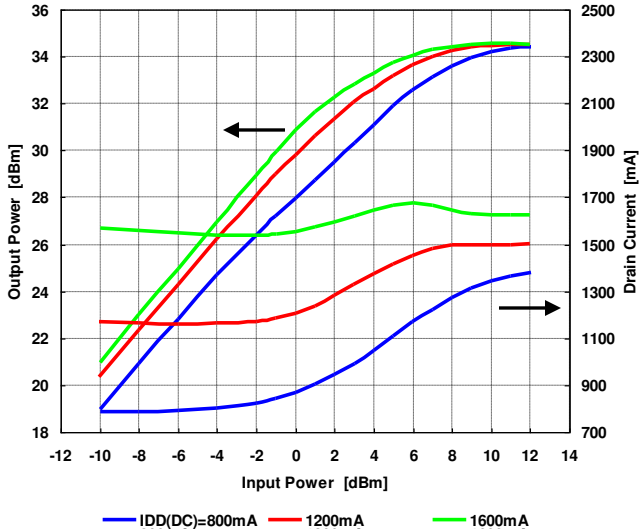

Output Power, Drain Current vs. Input Power by Drain Current

@f=7.1GHz, VDD=6V

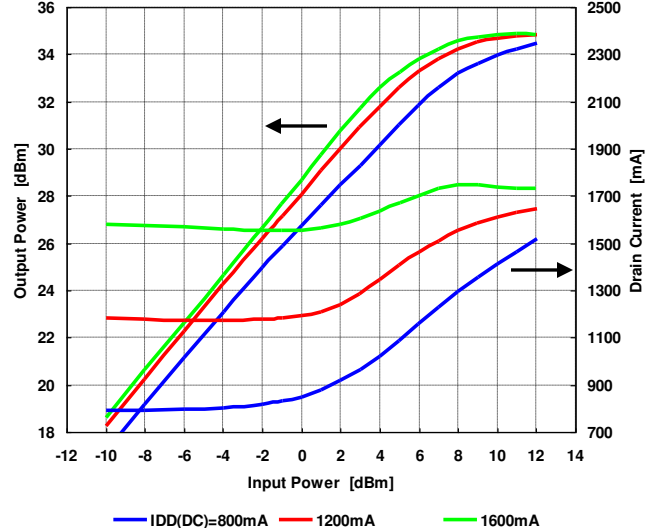

Output Power, Drain Current vs. Input Power by Drain Current

@f=8.5GHz, VDD=6V

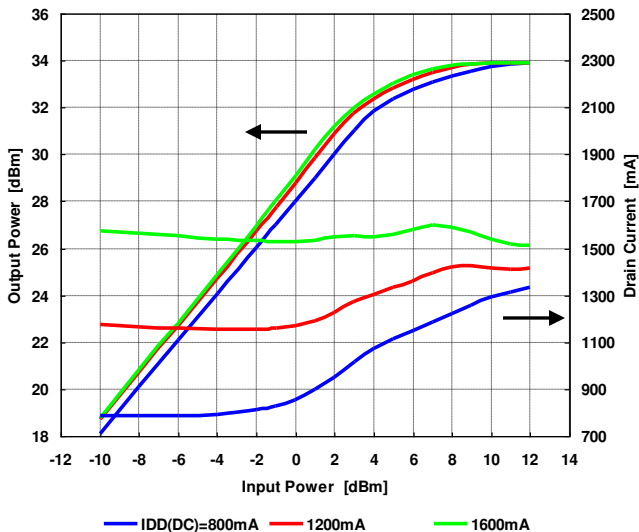

IMD vs. Output Power by Drain Voltage

@f=5.8GHz, IDD(DC)=1200mA

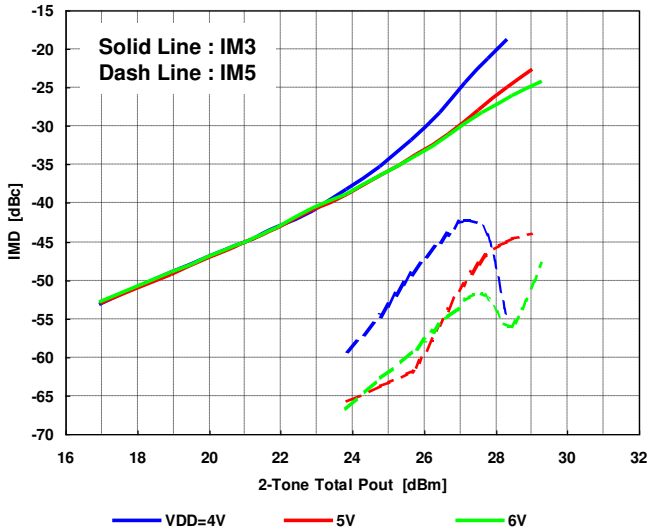

IMD vs. Output Power by Drain Voltage

@f=7.1GHz, IDD(DC)=1200mA

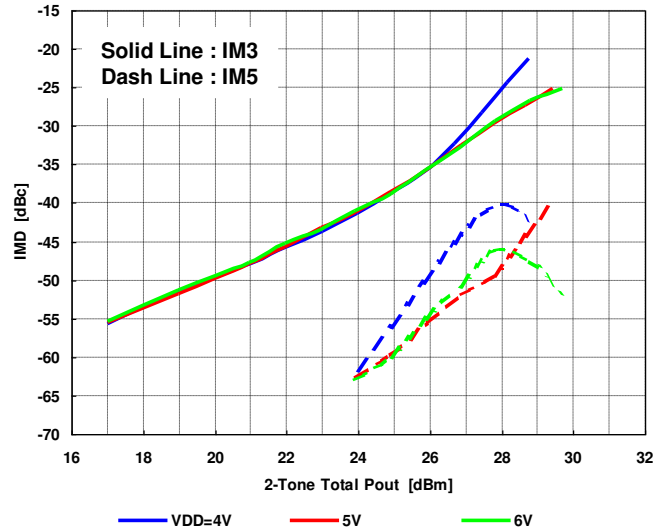

IMD vs. Output Power by Drain Voltage

@f=8.5GHz, IDD(DC)=1200mA

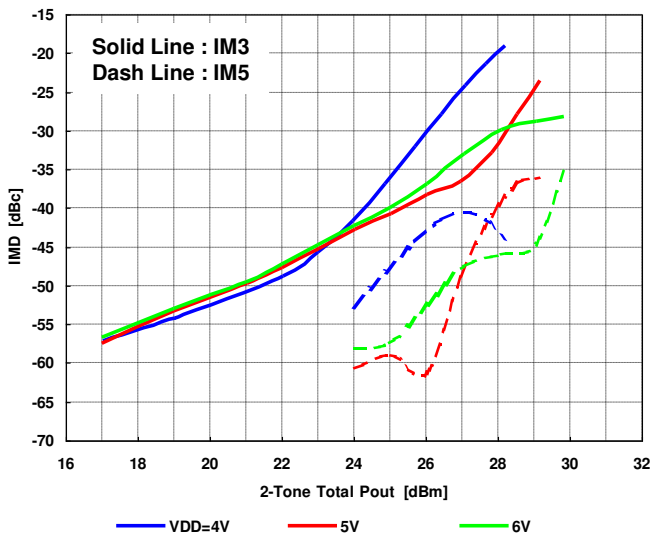

IMD vs. Output Power by Drain Current

@f=5.8GHz, VDD=6V

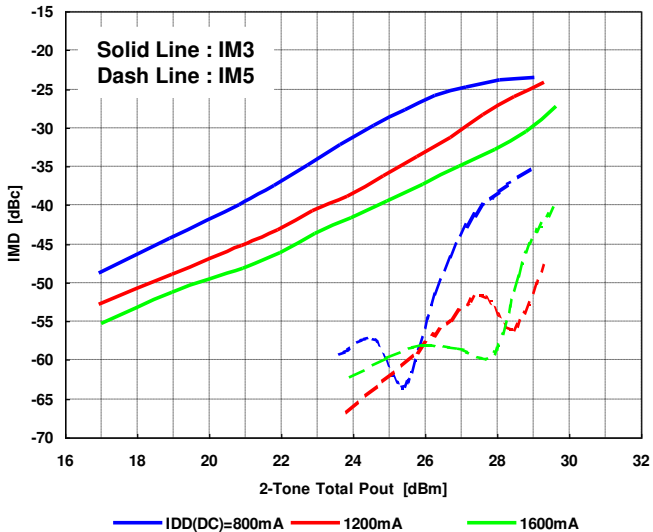

IMD vs. Output Power by Drain Current

@f=7.1GHz, VDD=6V

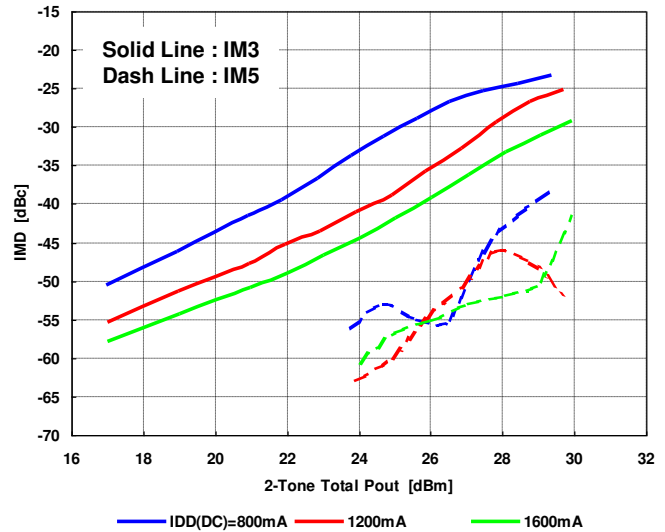

IMD vs. Output Power by Drain Current

@f=8.5GHz, VDD=6V

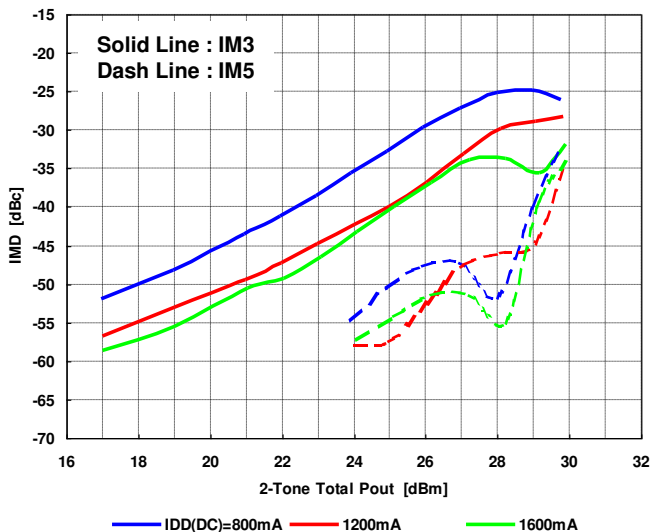

OUTPUT POWER, DRAIN CURRENT vs. INPUT POWER by Temperature

@VDD=6V, IDD(DC)=1200mA(Tc=+25deg.C), Freq.=5.8GHz

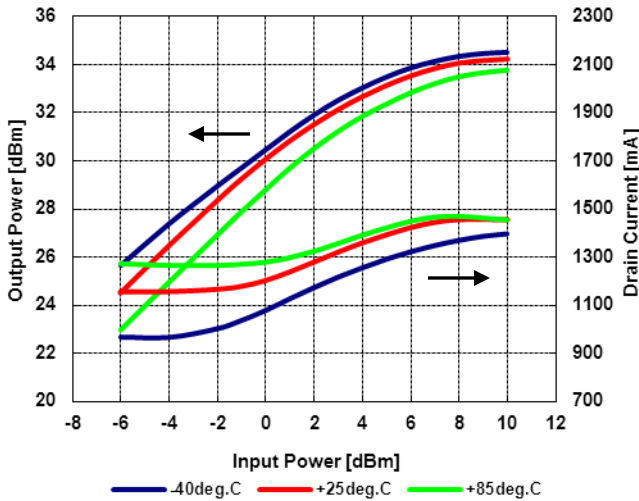

OUTPUT POWER, DRAIN CURRENT vs. INPUT POWER by Temperature

@VDD=6V, IDD(DC)=1200mA(Tc=+25deg.C), Freq.=7.1GHz

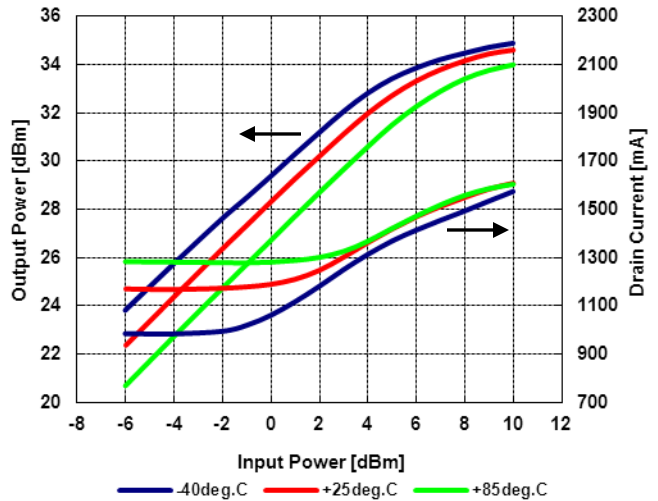

OUTPUT POWER, DRAIN CURRENT vs. INPUT POWER by Temperature

@VDD=6V, IDD(DC)=1200mA(Tc=+25deg.C), Freq.=8.5GHz

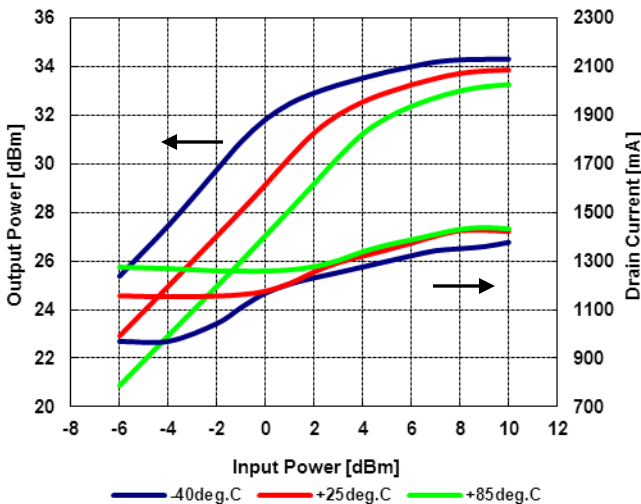

OUTPUT POWER, GAIN vs. TEMPERATURE

@VDD=6V, IDD(DC)=1200mA(Tc=+25deg.C)

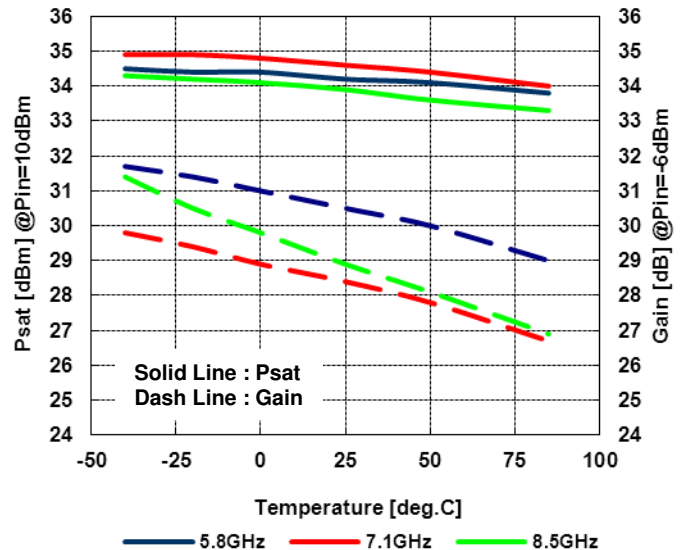

■ S-Parameter

VDD=6V, IDD(DC)=1200mA

Input/Output Return Loss vs. Frequency

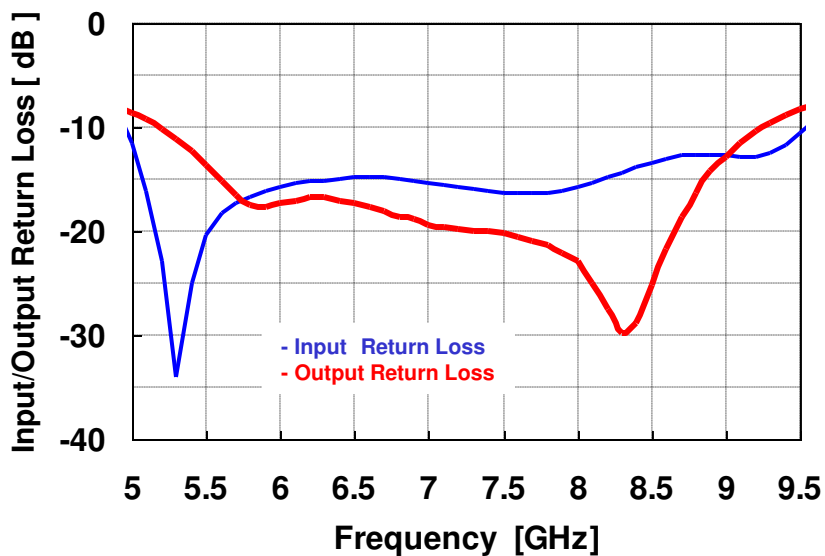

Small Signal Gain vs. Frequency

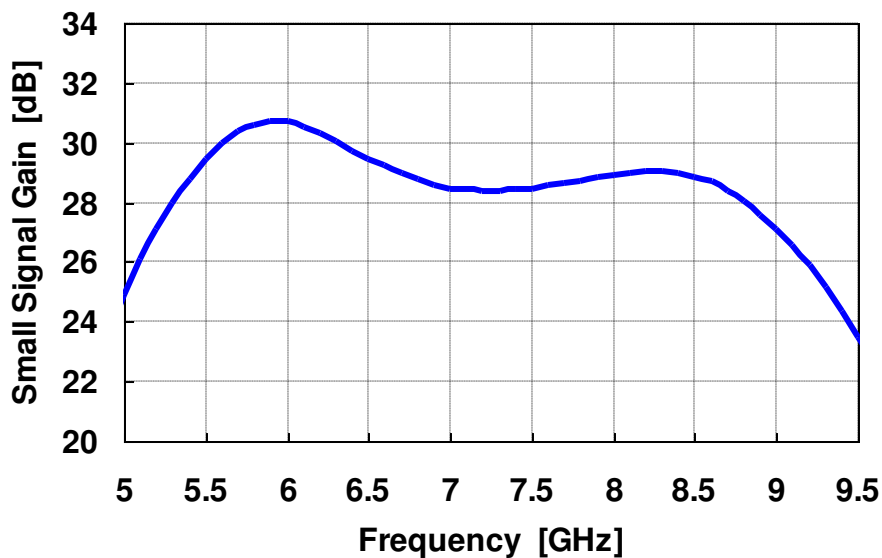

■ S-Parameter

VDD=6V, IDD(DC)=1200mA

Frequency [GHz]	S11		S21		S12		S22	
	MAG	ANG	MAG	ANG	MAG	ANG	MAG	ANG
5.0	0.262	30.2	17.543	-56.0	0.000	-108.8	0.370	-74.5
5.1	0.157	11.5	20.174	-80.8	0.000	-3.4	0.342	-89.3
5.2	0.072	-12.5	22.695	-105.3	0.000	-141.0	0.313	-105.0
5.3	0.020	-99.5	25.097	-129.3	0.000	-45.2	0.278	-122.2
5.4	0.057	179.4	27.472	-153.0	0.000	-8.7	0.242	-141.3
5.5	0.095	160.6	29.615	-176.8	0.000	-155.6	0.206	-163.2
5.6	0.122	150.2	31.529	159.6	0.000	-168.0	0.173	171.9
5.7	0.137	141.4	33.070	136.2	0.000	171.9	0.148	142.6
5.8	0.147	133.8	33.937	112.8	0.000	-51.8	0.134	110.6
5.9	0.155	127.1	34.309	90.0	0.000	-49.8	0.131	80.0
6.0	0.163	121.5	34.227	67.7	0.000	-111.6	0.136	53.3
6.1	0.170	117.8	33.559	46.3	0.000	-138.4	0.141	31.7
6.2	0.174	113.0	32.721	25.8	0.000	-163.6	0.145	14.5
6.3	0.175	108.1	31.764	6.0	0.000	161.8	0.144	0.6
6.4	0.177	102.5	30.689	-13.1	0.000	-122.8	0.141	-11.1
6.5	0.180	95.8	29.747	-31.3	0.000	-156.8	0.135	-20.3
6.6	0.180	90.1	28.885	-49.1	0.000	-162.7	0.129	-28.1
6.7	0.180	84.3	28.009	-66.3	0.000	-140.0	0.124	-33.9
6.8	0.176	78.5	27.365	-82.9	0.000	171.1	0.117	-39.4
6.9	0.172	71.2	26.923	-99.6	0.000	-175.8	0.113	-44.5
7.0	0.169	64.1	26.479	-115.9	0.000	-114.8	0.108	-48.9
7.1	0.167	56.7	26.371	-132.1	0.000	-148.5	0.105	-53.5
7.2	0.164	50.3	26.189	-148.3	0.000	-148.1	0.102	-59.2
7.3	0.159	42.7	26.180	-164.6	0.000	-179.7	0.101	-65.0
7.4	0.154	34.8	26.344	178.9	0.000	-76.2	0.099	-72.3
7.5	0.152	26.4	26.509	162.4	0.000	-101.1	0.098	-80.2
7.6	0.152	18.4	26.756	145.6	0.000	-122.4	0.094	-89.0
7.7	0.154	11.0	27.090	128.5	0.000	-124.8	0.090	-98.2
7.8	0.154	4.1	27.338	111.2	0.000	-126.7	0.086	-109.0
7.9	0.156	-3.7	27.642	93.5	0.001	-127.1	0.079	-121.1
8.0	0.163	-12.2	27.971	75.5	0.001	-127.1	0.071	-136.5
8.1	0.171	-19.8	28.114	57.1	0.001	-138.4	0.056	-151.4
8.2	0.182	-27.4	28.302	38.5	0.001	-146.1	0.042	-173.5
8.3	0.192	-35.4	28.314	19.2	0.001	-170.0	0.032	145.6
8.4	0.201	-45.0	28.082	-0.2	0.001	-168.1	0.036	89.2
8.5	0.213	-56.0	27.775	-20.1	0.001	-157.6	0.054	48.3
8.6	0.224	-67.9	27.174	-40.2	0.001	-175.4	0.083	25.5
8.7	0.231	-80.6	26.284	-60.4	0.001	176.9	0.117	7.0
8.8	0.233	-95.2	25.281	-80.9	0.001	159.3	0.152	-7.9
8.9	0.231	-111.2	23.980	-101.2	0.000	161.7	0.195	-20.6
9.0	0.230	-130.1	22.667	-121.4	0.000	156.4	0.228	-32.6
9.1	0.229	-150.3	21.239	-141.7	0.000	-169.6	0.266	-42.6
9.2	0.229	-172.4	19.653	-161.8	0.000	-146.4	0.300	-52.1
9.3	0.238	163.4	18.126	178.3	0.000	-143.6	0.330	-61.1
9.4	0.260	139.1	16.569	158.1	0.000	-131.6	0.358	-69.0
9.5	0.295	116.2	14.970	138.4	0.001	-119.5	0.383	-76.4

ΔT_{ch} vs. DRAIN VOLTAGE (Reference Data)

$I_{DD}(DC)=1200mA$

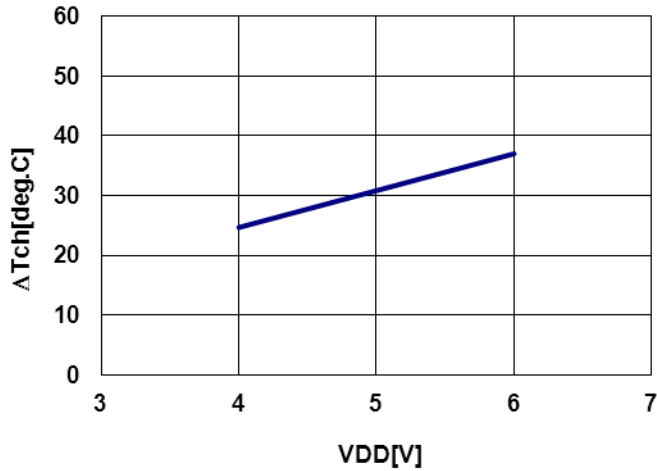

Note : ΔT_{ch} : Temperature Rise from Backside of Package to Channel

MTTF vs. T_{ch}

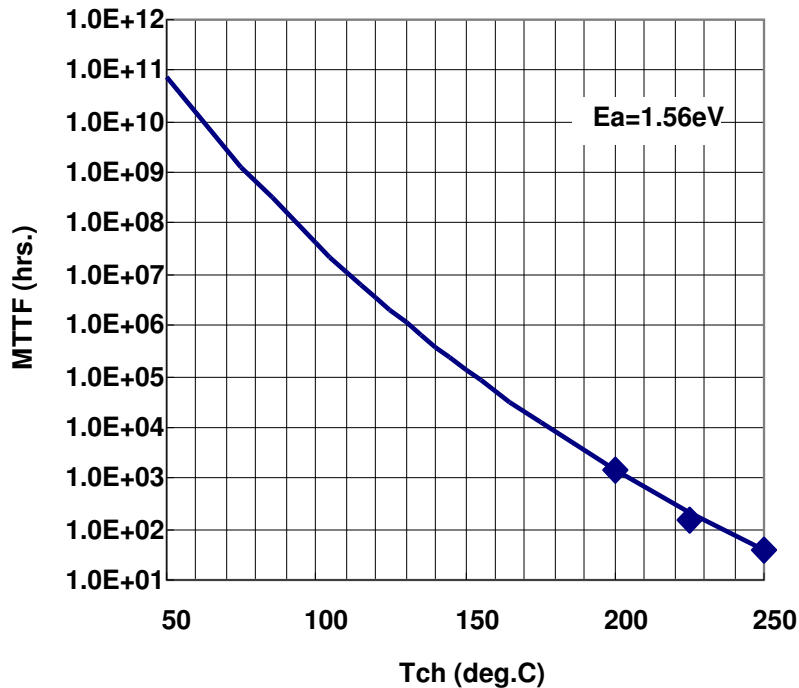

■ Block diagram

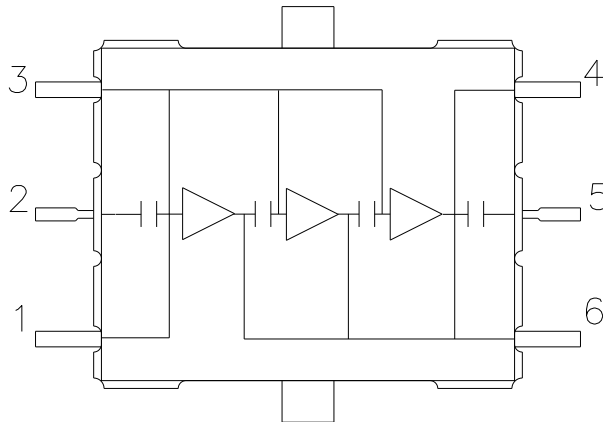

PIN ASSIGNMENT

- 1 : VGG
- 2 : RF in
- 3 : VGG
- 4 : VDD
- 5 : RF out
- 6 : VDD

■ Recommended Bias Circuit

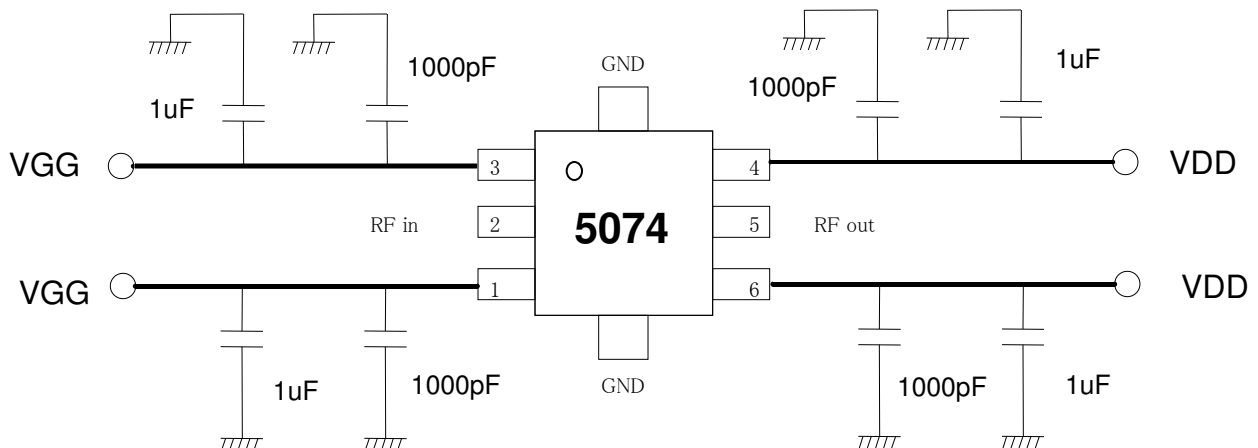

Note 1: The capacitors are recommended on the bias supply line, close to the package, in order to prevent video oscillations which could damage the module.

Note 2: Two pins named VGG are internally connected.

Note 3: Two pins named VDD are internally connected.

Package Outline

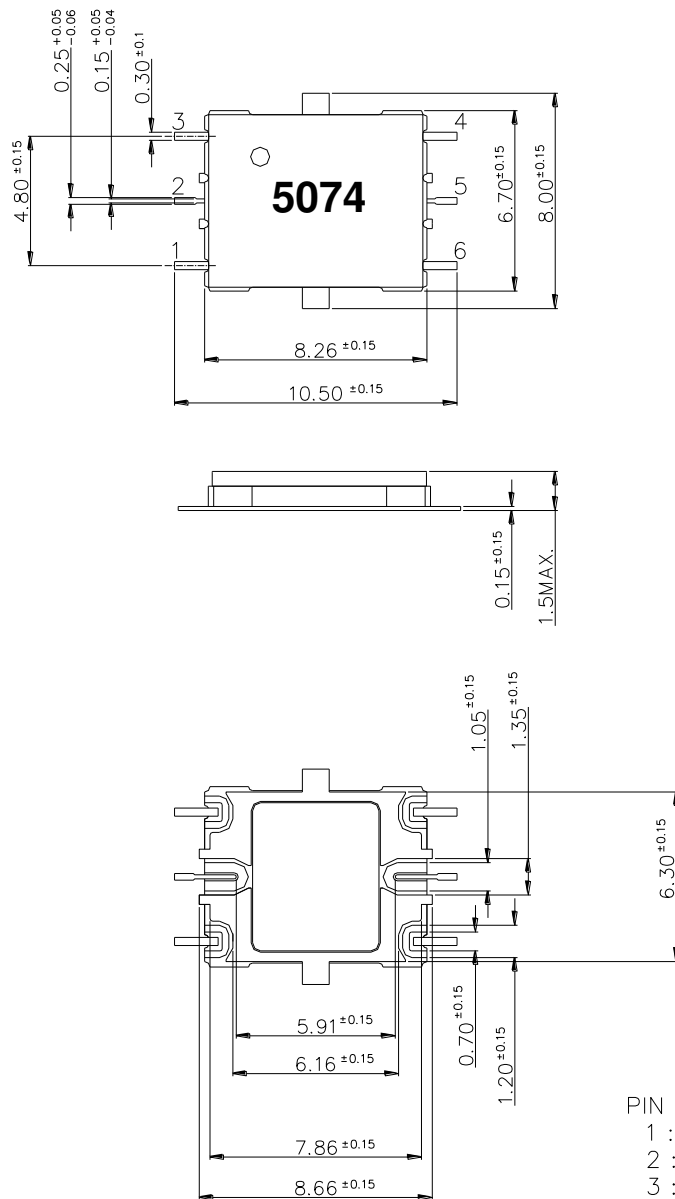

PIN Assignments

- 1 : VGG
- 2 : RF in
- 3 : VGG
- 4 : VDD
- 5 : RF out
- 6 : VDD

Unit : mm

■ PCB Pads and Solder-resist Pattern

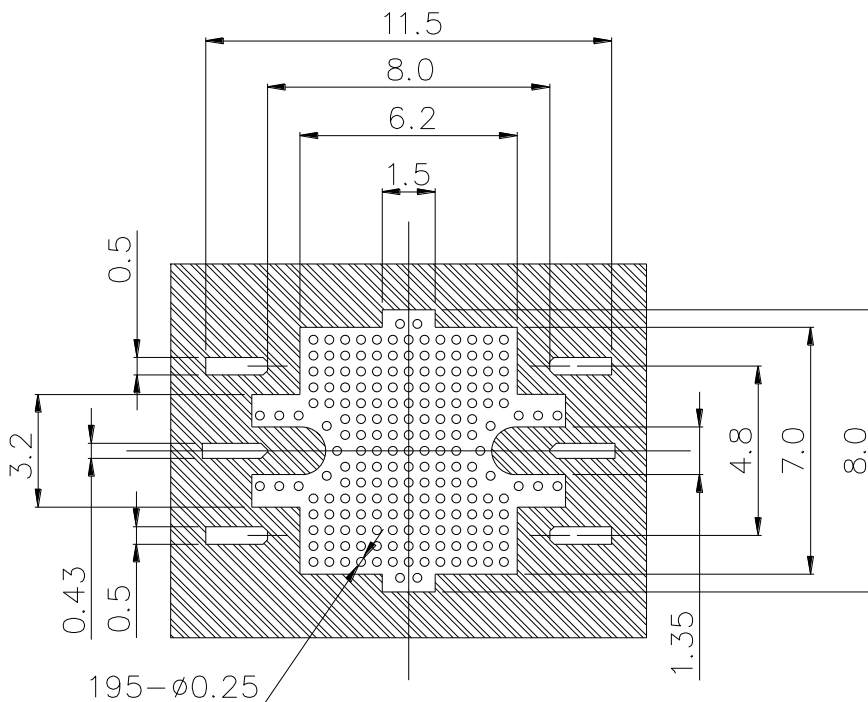

Notes :

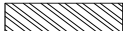
- 1.LAMINATE : Rogers Corporation RO4003, Thickness $t=0.2\text{mm}$, Cu Foil $18\mu\text{m}$
Finish to copper foil ; Ni $0.1\mu\text{m}$ min./Au $0.1\pm 0.08\mu\text{m}$ (Both side)
2.  : Resist

■ Marking Information

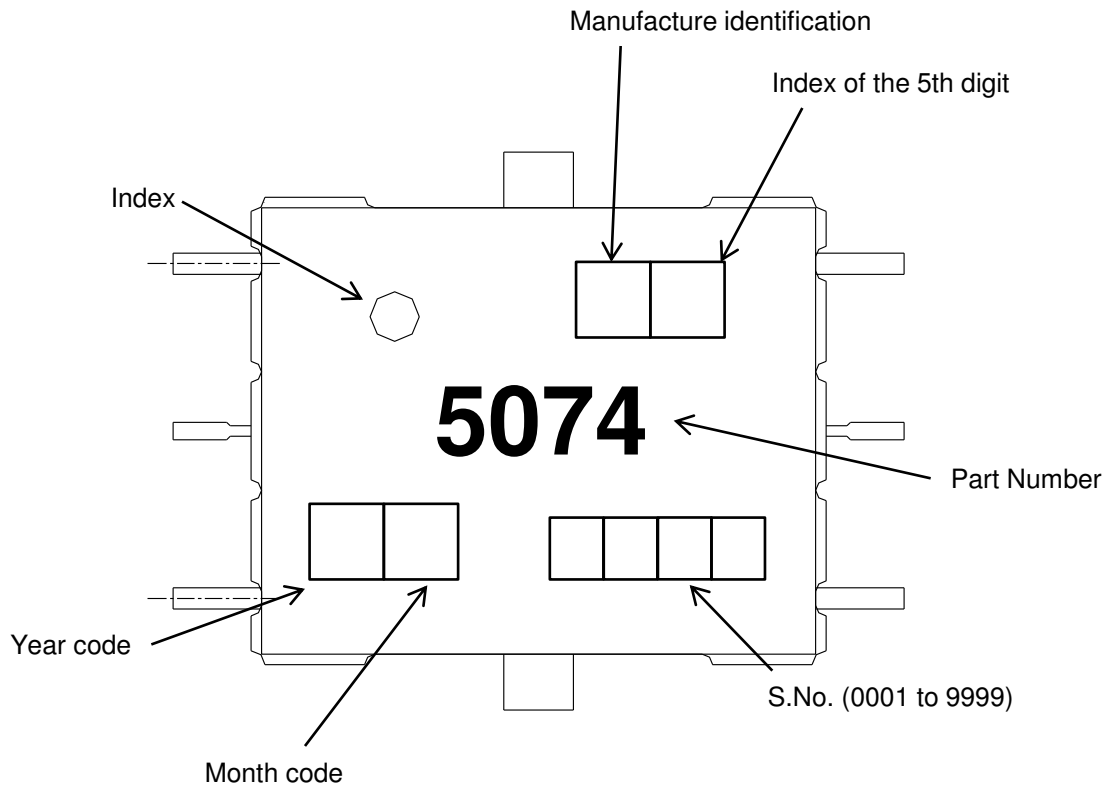

<Year code>

Code	T	U	V	W	X	Y	Z	A	B
Year	2011	2012	2013	2014	2015	2016	2017	2018	2019

<Month code>

Code	H	M	N	P	R	S	T	U	W	X	Y	Z
Month	1	2	3	4	5	6	7	8	9	10	11	12

■ 4-inch Tray Packing (Part No. : EMM5074VU)

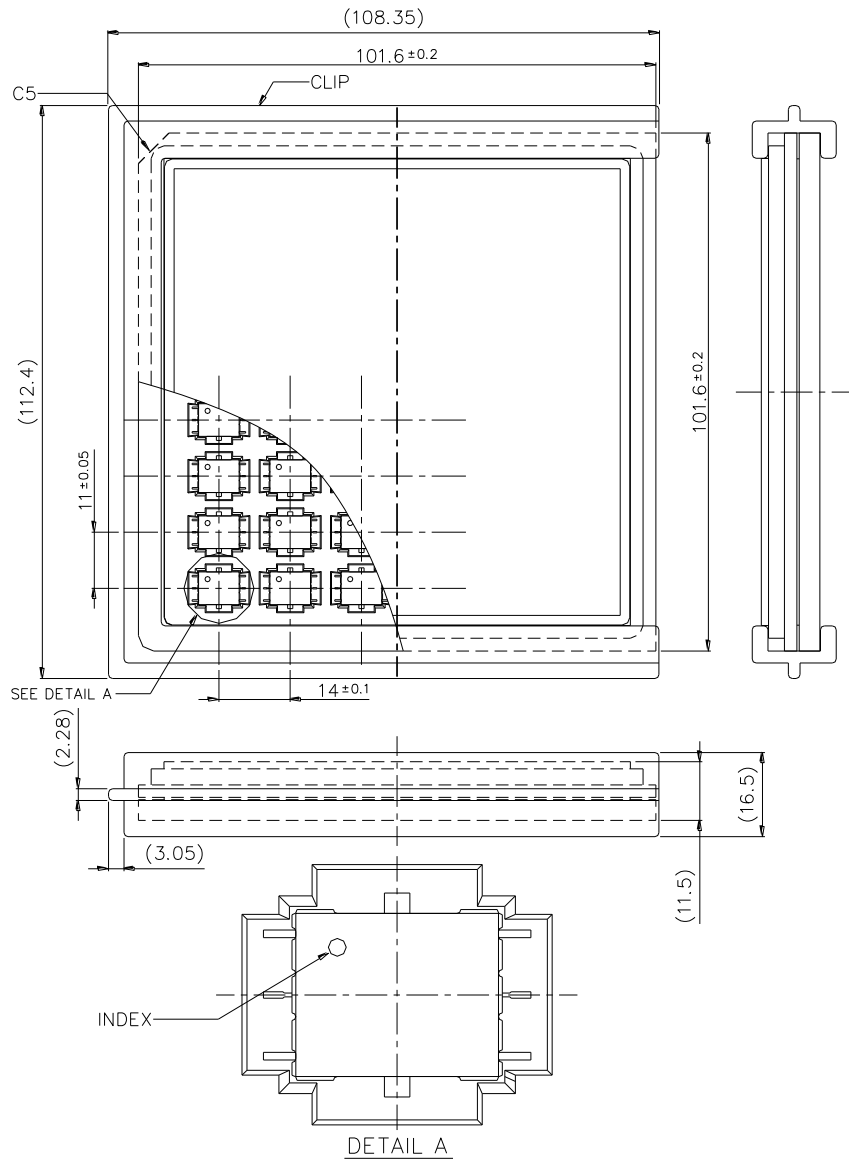

- (1) Maximum Quantity : 48 pcs./Tray
- (2) Tray Material : Conductive PS

■ Tape and Reel Packing (Part No. : EMM5074VUT)

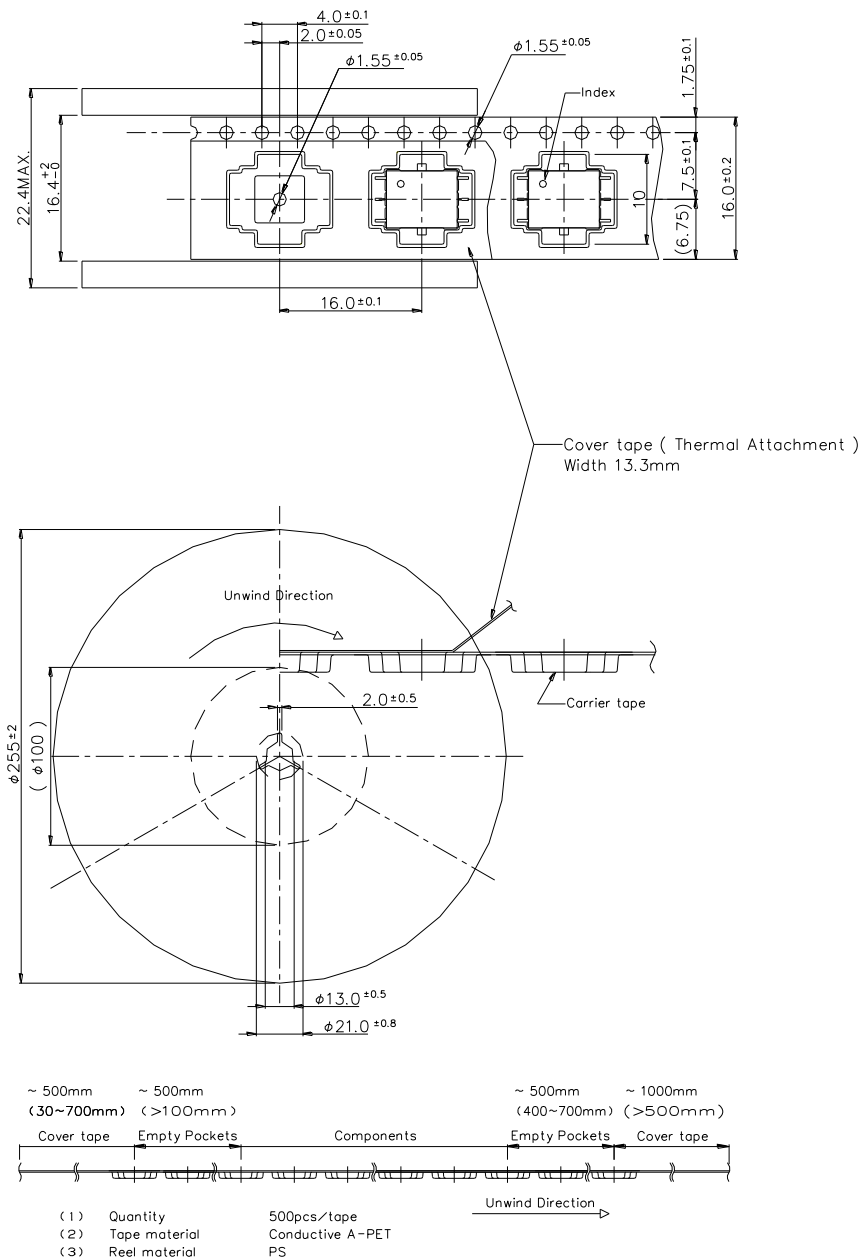

■ Mounting Method of SMD(Surface Mount Devices) for Lead-free solder

Mounting Condition

- (1) For soldering, Lead-free solder (Sn-3.0Ag-0.5Cu)*1 or equivalent shall be used.
(*1: The figure displays with weight %. A predominantly tin-rich alloy with 3.0% silver and 0.5% copper.)
- (2) A rosin type flux with a chlorine content of 0.2% or less shall be used. The rosin flux with low halogen content is recommended.
- (3) When soldering, use one of the following time / temperature methods for acceptable solder joints. Make sure the devices have been properly prepared with flux prior soldering.

* Reflow soldering method (Infrared reflow / Heat circulation reflow / Hot plate reflow):

Limit solder to 3 reflow cycles because resin is used in the modules manufacturing process. Excessive reflow cycles will effect the resin resulting in a potential failure or latent defect. The recommended reflow temperature profile is shown below. The temperature of the reflow profile must be measured at the device body surface.

Reflow temperature profile and condition:

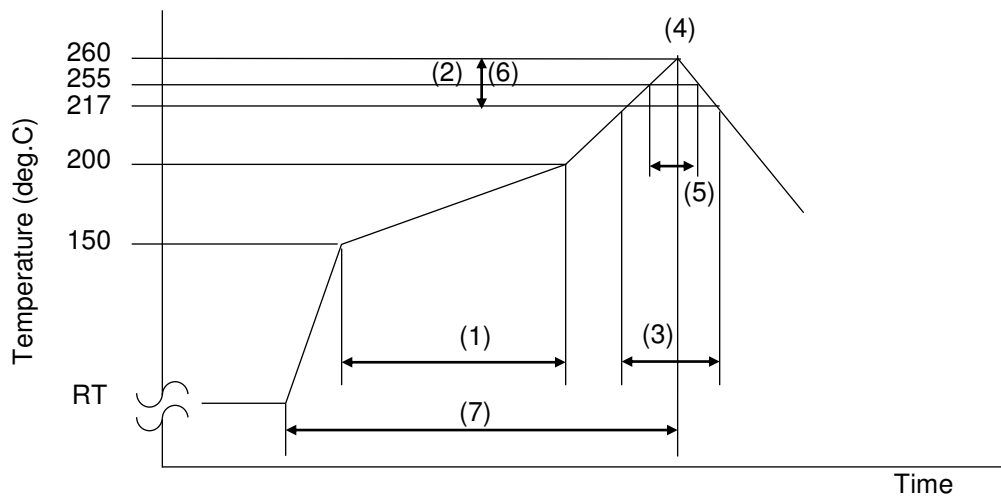

- | | |
|-------------------------------------|-------------------------------------|
| (1) Preheating: | 150 to 200 deg.C, 60 to 120 seconds |
| (2) Ramp-up Rate: | 3 deg.C /seconds max |
| (3) Liquidous temperature and time: | 217 deg.C, 60 to 150 seconds |
| (4) Peak Temperature: | 260 deg.C |
| (5) Time Peak Temperature: | 255deg.C, 30seconds max |
| (6) Ramp-down Rate: | 6 deg.C /seconds max |
| (7) Time RT to peak temperature: | 8 minutes max |

* Measurement point: Center of the package body surface

- (4) The above-recommended conditions were confirmed using the manufacture's equipment and materials. However, when soldering these products, the soldering condition should be verified by customer using their equipment and materials.



EMM5074VU

C-Band Power Amplifier MMIC

For further information please contact:

<http://global-sei.com/Electro-optic/about/office.html>

CAUTION

This product contains **gallium arsenide (GaAs)** which can be hazardous to the human body and the environment. For safety, observe the following procedures:

- Do not put these products into the mouth.
- Do not alter the form of this product into a gas, powder, or liquid through burning, crushing, or chemical processing as these by-products are dangerous to the human body if inhaled, ingested, or swallowed.
- Observe government laws and company regulations when discarding this product. This product must be discarded in accordance with methods specified by applicable hazardous waste procedures.